

**Datenblatt**  
Positionsschalter D4B Serie  
D4B



<b>Bezeichnung</b>	D4B
<b>Schutzart</b>	IP67
<b>Betriebstemperatur</b>	-40°C ... 80°C
<b>Gehäusematerial</b>	Metall
<b>Schraubanschluss</b>	M20, G1/2, 1/2-14NPT
<b>Kabelsteckverbinder</b>	-

## Safety Limit Switch D4B-□□□N

CSM\_D4B-\_N\_DS\_E\_7\_1

### Robust safety limit switch with metal housing Slow-action and snap-action contact with certified direct opening operation certification ☹

Note: Contact your sales representative for details on models with safety standard certification.



- Direct opening mechanism (NC contacts only) added to enable opening contacts when faults occur, such as fused contacts.
- Safety of lever settings ensured using a mechanism that engages a gear between the operating position indicator plate and the lever.
- Equipped with a mechanism that indicates the applicable operating zone, as well as push-button switching to control left and right motion.
- Head seal structure strengthened to improve seal properties (TÜV: IEC IP67, UL: NEMA 3, 4, 4X, 6P, and 13).
- Wide standard operating temperature range: -40 to 80°C (standard type).
- Certified standards: UL, CSA, EN (TÜV), and CCC.



For the most recent information on models that have been certified for safety standards, refer to your OMRON website.

Be sure to read the "Safety Precautions" on page 9.

## Model Number Structure

### Model Number Legend

D4B-□□□□N

1 2 3

#### 1. Conduit size

- 2: G1/2 (PF1/2) (1-conduit)
- 4: M20 (1 conduit)

#### 2. Built-in Switch

- 1: 1NC/1NO (snap-action)
- 5: 1NC/1NO (slow-action)
- A: 2NC (slow-action)

#### 3. Actuator

- 11: Roller lever (resin roller)
- 15: Roller lever (stainless steel roller)
- 16: Adjustable roller lever
- 17: Adjustable rod lever
- 70: Top plunger
- 71: Top roller plunger





D4B-□N

## Ordering Information



### Set Model Numbers

Consult with your OMRON representative when ordering any models that are not listed in this table.

#### Safety Limit Switches (with Direct Opening Mechanism)

Actuator	Conduit openings	1NC/1NO (Snap-action)		1NC/1NO (Slow-action)		2NC (Slow-action)	
		Model	Direct opening	Model	Direct opening	Model	Direct opening
Roller lever (resin roller) 	G1/2 (PF1/2)	D4B-2111N	→	D4B-2511N	→	D4B-2A11N	→
	M20	D4B-4111N		D4B-4511N		D4B-4A11N	
Roller lever (stainless steel roller) 	G1/2 (PF1/2)	D4B-2115N	→	D4B-2515N	→	D4B-2A15N	→
	M20	D4B-4115N		D4B-4515N		D4B-4A15N	
Top plunger 	G1/2 (PF1/2)	D4B-2170N	→	D4B-2570N	→	D4B-2A70N	→
	M20	D4B-4170N		D4B-4570N		D4B-4A70N	
Top roller plunger 	G1/2 (PF1/2)	D4B-2171N	→	D4B-2571N	→	D4B-2A71N	→
	M20	D4B-4171N		D4B-4571N		D4B-4A71N	

#### General-purpose Limit Switches

Actuator	Conduit openings	1NC/1NO (Snap-action)		1NC/1NO (Slow-action)		2NC (Slow-action)	
		Model	Direct opening	Model	Direct opening	Model	Direct opening
Adjustable roller lever 	G1/2 (PF1/2)	D4B-2116N	---	D4B-2516N	---	D4B-2A16N	---
	M20	D4B-4116N		D4B-4516N		D4B-4A16N	
Adjustable rod lever 	G1/2 (PF1/2)	D4B-2117N	---	D4B-2517N	---	D4B-2A17N	---
	M20	D4B-4117N		D4B-4517N		D4B-4A17N	

Note: Consult your OMRON representative for products.

D4B-□N

## Specifications

### Standards and EC Directives

#### Conforms to the following EC Directives:

- Machinery Directive
- Low Voltage Directive
- EN50041
- EN60204-1
- EN1088

### Certified Standards

#### Snap-action Models

Certification body	Standard	File No.
TÜV Rheinland	EN60947-5-1 (certified direct opening mechanism) GS-ET-15	J9851083 
	EN60947-5-1 (uncertified direct opening mechanism)	J50005477 *
UL	UL508	E76675
CSA	C22.2 No. 14	LR45746
CQC (CCC)	GB14048.5	2003010305077612

\* Adjustable roller lever, adjustable rod lever only.

#### Slow-action Models

Certification body	Standard	File No.
TÜV Rheinland	EN60947-5-1 (certified direct opening mechanism) GS-ET-15	J9851083 
	EN60947-5-1 (uncertified direct opening mechanism)	J50005477 *
UL	UL508	E76675
CSA	C22.2 No. 14	LR45746
CQC (CCC)	GB14048.5	2003010305077612

\* Adjustable roller lever, adjustable rod lever only.

### Certified Standard Ratings

#### TÜV (EN60947-5-1), CCC (GB14048.5)

Item	Utilization category	AC-15
Rated operating current (I <sub>o</sub> )		2 A
Rated operating voltage (U <sub>o</sub> )		400 V

Note: As protection against short-circuiting, use either a gI-type or gG-type 10 A fuse that conforms to IEC60269.

#### UL/CSA: (UL508, CSA C22.2 No. 14)

##### A600

Rated voltage	Carry current	Current (A)		Volt-amperes (VA)	
		Make	Break	Make	Break
120 VAC	10 A	60	6	7,200	720
240 VAC		30	3		
480 VAC		15	1.5		
600 VAC		12	1.2		

D4B-□N

### Ratings

Rated voltage (V)	Non-inductive load (A)				Inductive load (A)			
	Resistive load		Lamp load		Inductive load		Motor load	
	NC	NO	NC	NO	NC	NO	NC	NO
125 VAC	10		3	1.5	10		5	2.5
250	10		2	1	10		3	1.5
400	10		1.5	0.8	3		1.5	0.8
8 VDC	10		6	3	10		6	
14	10		6	3	10		6	
30	6		4	3	6		4	
125	0.8		0.2	0.2	0.8		0.2	
250	0.4		0.1	0.1	0.4		0.1	

- Note:** 1. The above values are continuous currents.  
 2. Inductive loads have a power factor of 0.4 or higher (AC) or a time constant of 7 ms or lower (DC).  
 3. Lamp loads have a inrush current of 10 times the normal current.  
 4. Motor loads have a inrush current of 6 times the normal current.

<b>Inrush current</b>	30 A max.
-----------------------	-----------

### Characteristics

<b>Degree of protection *1</b>		IP67 (EN60947-5-1)
<b>Durability *2</b>	<b>Mechanical</b>	30,000,000 operations min. (snap-action) 10,000,000 operations min. (slow-action)
	<b>Electrical</b>	500,000 operations min. (10 A resistive load at 250 VAC)
<b>Operating speed</b>		1 mm/s to 0.5 m/s
<b>Operating frequency</b>	<b>Mechanical</b>	120 operations/minute
	<b>Electrical</b>	30 operations/minute
<b>Contact resistance</b>		25 mΩ max.
<b>Minimum applicable load *3</b>		General load 180 mA resistive load at 5 VAC Gold-clad contact 20 mA resistive load at 5 VAC (N-level reference value)
<b>Rated insulation voltage (U<sub>i</sub>)</b>		600 V (EN60947-5-1)
<b>Rated frequency</b>		50/60 Hz
<b>Protection against electric shock</b>		Class I (with ground terminal)
<b>Pollution degree (operating environment)</b>		3 (EN60947-5-1)
<b>Impulse withstand voltage (EN60947-5-1)</b>	<b>Between terminals of same polarity</b>	2.5 kV (snap-action)/4 kV (slow-action)
	<b>Between terminals of different polarity</b>	4 kV (slow-action)
	<b>Between each terminal and ground</b>	4 kV
<b>Insulation resistance</b>		100 MΩ min. (at 500 VDC) between terminals of the same polarity and between each terminal and non-current-carrying part
<b>Contact gap</b>		2 × 2 mm min. (slow-action) 2 × 0.5 mm min. (snap-action)
<b>Vibration resistance</b>	<b>Malfunction</b>	10 to 55 Hz, 0.75 mm single amplitude
	<b>Destruction</b>	1,000 m/s <sup>2</sup> min.
<b>Shock resistance</b>	<b>Malfunction</b>	300 m/s <sup>2</sup> min.
<b>Conditional short-circuit current</b>		100 A (EN60947-5-1)
<b>Conventional enclosed thermal current (I<sub>the</sub>)</b>		20 A (EN60947-5-1)
<b>Ambient operating temperature</b>		-40 to 80°C (with no icing)
<b>Ambient operating humidity</b>		95% max.
<b>Weight</b>		Approx. 250 g

- Note:** 1. The above values are initial values.  
 2. The above values may vary depending on the model. Consult your OMRON sales representative for details.  
 \*1. The degree of protection is tested using the method specified by the standard (EN60947-5-1). Confirm that sealing properties are sufficient for the operating conditions and environment beforehand.  
 \*2. The durability is for an ambient temperature of 5 to 35°C and ambient humidity of 40% to 70%. For further conditions, consult your OMRON sales representative.  
 \*3. The above values may vary depending on switching frequency, environmental condition, and relativity level, consult your OMRON sales representative.

D4B-□N

**Engineering Data**

**Electrical Durability (Snap-action)**

(Ambient temperature: 5 to 30°C, ambient humidity: 40 to 70%)

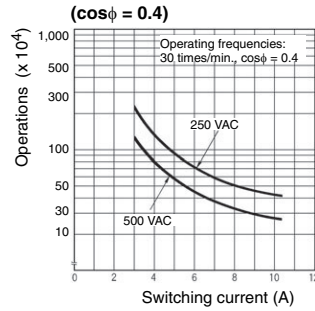
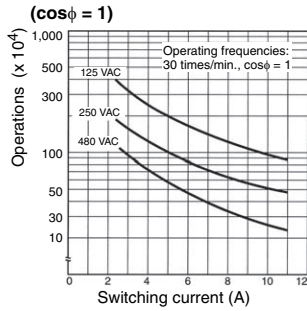

**Structure and Nomenclature**

**Structure**

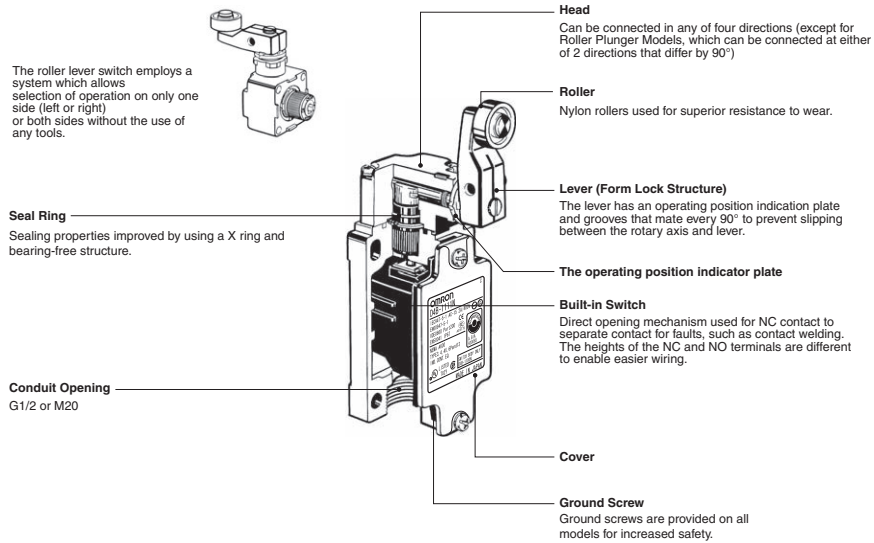

D4B-□N

**Direct Opening Mechanism**  
**1NO/1NC Contact (Snap-action)**

Conforms to EN60947-5-1 Direct Opening ⊕ (Only NC contact has a direct opening mechanism.)

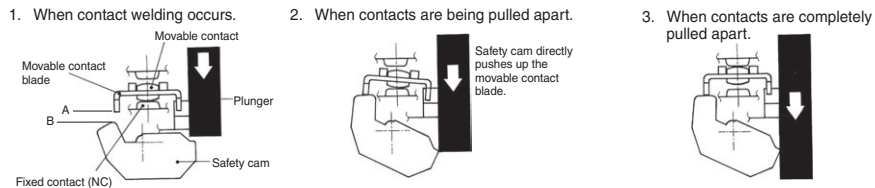

**1NC/1NO Contact (Slow-action)**

Conforms to EN60947-5-1 Direct Opening ⊕ (Only NC contact has a direct opening mechanism.)  
When contact welding occurs, the contacts are separated from each other by the plunger being pushed in.

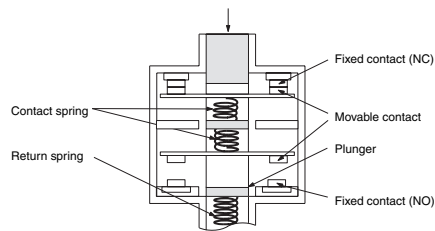

**2NC Contact (Slow-action)**

Conforms to EN60947-5-1 Direct Opening ⊕ (Both NC contacts have a direct opening mechanism.)  
When contact welding occurs, the contacts are separated from each other by the plunger being pushed in.

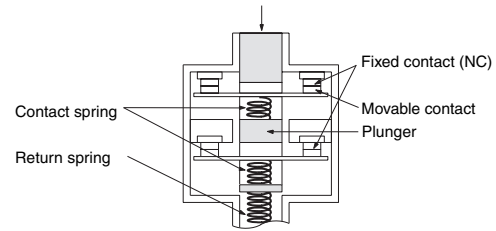

**Contact Form**

Model	Contact	Contact form	Diagrams	Explanation
D4B-□1□N	1NC/1NO (Snap-action)			Only NC contact 11-12 has a certified direct opening mechanism. ⊕ Terminal numbers 11-12 and 13-14 cannot be used as unlike poles.
D4B-□5□N	1NC/1NO (Slow-action)			Only NC contact 11-12 has a certified direct opening mechanism. ⊕ Terminal numbers 11-12 or 23-24 can be used as unlike poles.
D4B-□A□N	2NC (Slow-action)			Both NC contacts 11-12 and 21-22 have a certified direct opening mechanism. ⊕ Terminal numbers 11-12 and 21-22 can be used as unlike poles.

**Note:** Terminal numbers are according to EN50013; contact symbols are according to IEC60947-5-1.

D4B-□□N

Dimensions and Operating Characteristics

(Unit: mm)

Note: Omitted dimensions are the same as those for the Roller Lever Type Models  
D4B-2□□□N have a G1/2 conduit opening.  
D4B-4□□□N have a M20 conduit opening.

Switches

Roller Lever  
D4B-□□11N

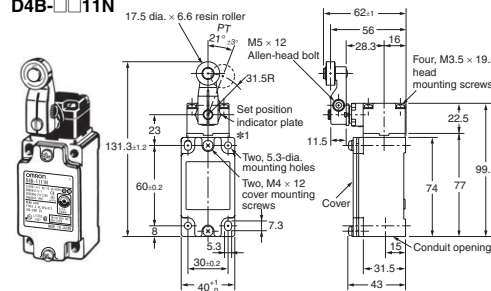

Roller Lever (Stainless Steel Roller)  
D4B-□□15N

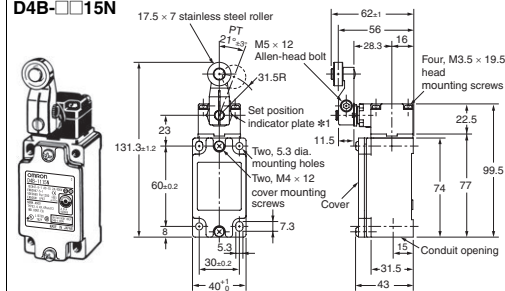

Adjustable Roller Lever #2  
D4B-□□16N

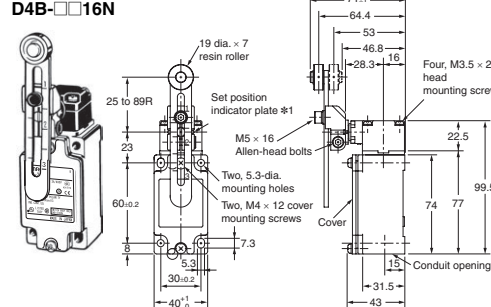

Adjustable Rod Lever #2  
D4B-□□17N

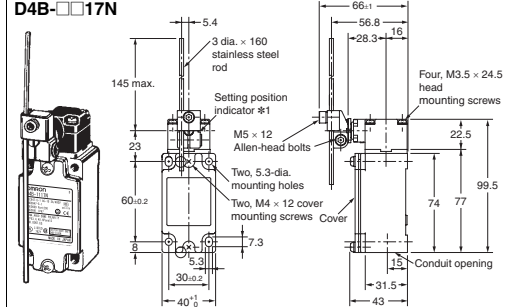

Note: Unless otherwise specified, a tolerance of  $\pm 0.4$  mm applies to all dimensions.  
\*1. The lever can be set to any desired position by turning the operating position indicator.  
\*2. In terms of construction, the Switch is a General-purpose Limit Switch rather than a Safety Limit Switch.

		Model	D4B-□□11N	D4B-□□15N	D4B-□□16N #1	D4B-□□17N #2
<b>Operating characteristics</b>						
Operating force	OF max.		9.41N	9.41N	9.41N	2.12N
Release force	RF min.		1.47N	1.47N	1.47N	0.29N
Pretravel	PT		$21^\circ \pm 3^\circ$	$21^\circ \pm 3^\circ$	$21^\circ \pm 3^\circ$	$21^\circ \pm 3^\circ$
	PT (2nd) #3 #5		(45°)	(45°)	(45°)	(45°)
Overtravel	OT min.		50°	50°	50°	50°
Movement differential	MD max. #4		12°	12°	12°	12°
Direct opening travel	DOT min. #3 #6		35°	35°	35°	35°
	#4 #6		55°	55°	55°	55°
Direct opening force	DOF min. #6		19.61N	19.61N	19.61N	19.61N
Total travel	TT #5		(75°)	(75°)	(75°)	(75°)

Note: Variation occurs in the simultaneity of contact opening/closing operations of 2NC contacts. Check contact operation.  
\*1. The operating characteristics of these Switches were measured with the roller level set at 31.5 mm.  
\*2. The operating characteristics of these Switches were measured with the rod level set at 140 mm.  
\*3. Only for slow-action models.  
\*4. Only for snap-action models.  
\*5. Reference values.  
\*6. Must be provided to ensure safe operation.



D4B-□N

**Top Plunger**  
D4B-□□70N

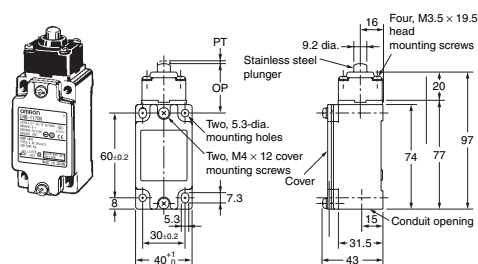

**Top Roller Plunger**  
D4B-□□71N

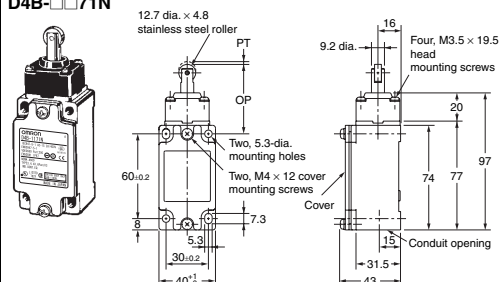

Note: Unless otherwise specified, a tolerance of  $\pm 0.4$  mm applies to all dimensions.

Operating characteristics		Model	D4B-□□70N	D4B-□□71N
Operating force	OF max.		18.63 N	18.63 N
Release force	RF min.		1.96 N	1.96 N
Pretravel	PT max.		2 mm	2 mm
	PT (2nd) *1 *3		(3 mm)	(3 mm)
Overtravel	OT min.		5 mm	5 mm
	MD max. *2		1 mm	1 mm
Direct opening travel	DOT min. *4		3.2 mm	3.2 mm
Direct opening force	DOF min. *4		49.03 N	49.03 N
Total travel	TT *3		(7 mm)	(7 mm)
Free position	FP max.		38 mm	51 mm
Operating position	OP		35±1 mm	48±1 mm

Note: Variation occurs in the simultaneity of contact opening/closing operations of 2NC contacts. Check contact operation.

- \*1. Only for slow-action models.
- \*2. Only for snap-action models.
- \*3. Reference values.
- \*4. Must be provided to ensure safe operation.

D4B-□N

### Application Precaution

#### Changing the Operating Direction Switches with Roller Levers

The operating direction of the lever can be easily changed without using any tools. It can be set to clockwise operation (CW) or counterclockwise (CCW) operation. Use the procedure given at the right to change the operating direction.

Operating section (on back of Head)	Operating procedure
	<ol style="list-style-type: none"> <li>1. Remove the four Head set screws and remove the Head from the Switch Box.</li> <li>2. Turn the bottom of the Head toward you, press in the Head Cover shown in the diagram at the left, and turn the Cover clockwise or counterclockwise. <b>Note:</b> The factory setting is for "CW.CCW."</li> <li>3. The "CW" setting is for clockwise operation and the "CCW" setting is for counterclockwise operation. Set the Cover to the desired position.</li> </ol>

### Safety Precautions

Be sure to read the precautions for **All Safety Limit Switches** in the website at: <http://www.ia.omron.com/>.

#### Indication and Meaning for Safe Use

Precautions for Safe Use	Supplementary comments on what to do or avoid doing, to use the product safely.
Precautions for Correct Use	Supplementary comments on what to do or avoid doing, to prevent failure to operate, or undesirable effect on product performance.

#### Precautions for Safe Use

- Do not use the Switch submerged in oil or water, or in locations continuously subject to splashes of oil or water. Doing so may result in oil or water entering the Switch interior. (The IP67 degree of protection specification for the Switch refers to water penetration while the Switch is submerged in water for a specified period of time.)
- Always attach the cover after completing wiring and before using the Switch. Also, do not turn ON the Switch with the cover open. Doing so may result in electric shock.

#### Precautions for Correct Use

#### Appropriate Tightening Torque

Be sure to tighten each screw of the D4B-□N properly, otherwise the D4B-□N may malfunction.

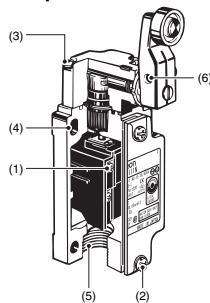

Type	Appropriate tightening torque
1 M3.5 terminal screw	0.59 to 0.78 N·m
2 Cover mounting screw *	1.18 to 1.37 N·m
3 Head mounting screw	0.78 to 0.88 N·m
4 M5 body mounting screw	4.90 to 5.88 N·m
5 Connector	1.77 to 2.16 N·m
6 Lever Mounting Screws (Roller Levers)	4.90 to 5.88 N·m

#### Mounting

Use four M5 screws with washers to mount the standard model. Be sure to apply the proper torque to tighten each screw.

#### Mounting Dimensions (M5)

##### Standard Model

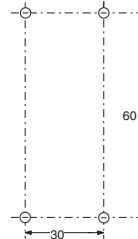

#### Changes in Actuator Mounting Position

- To change the angle of the lever, loosen the Allen-head bolts on the side of the lever.
- The operating position indicator plate \* has protruding parts which engage with the lever, thus allowing changes to the lever position by 90°.
- The back of the operating position indicator plate \* has no protruding parts. If this plate is turned over and attached, any angle within a 360° range can be set. Do not turn over the plate, however, when using the D4B-□N as a switch with a certified direct opening mechanism. For an SUVA- or BIA-certified application, make sure that the lever engages with the operating position indicator plate securely so that the lever will not slip.

\* The operating position indicator plate: Refer to page 5.

#### Changes in Head Mounting Position

By removing the screws on the four corners of the head, the head can be reset in any of four directions. Make sure that no foreign materials will penetrate through the head.

**D4B-□N**

**Wiring**

Do not connect the bare lead wires directly to the terminals but be sure to connect each of them by using an insulation tube and M3.5 round crimp terminals and tighten each terminal screw within the specified torque range.  
 The proper lead wire is 20 to 14 AWG (0.5 to 2.5 mm<sup>2</sup>) in size.

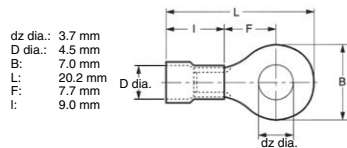

Make sure that all crimp terminals come into contact with the casing or cover as shown below, otherwise the cover may not be mounted properly or the D4B-□N may malfunction.

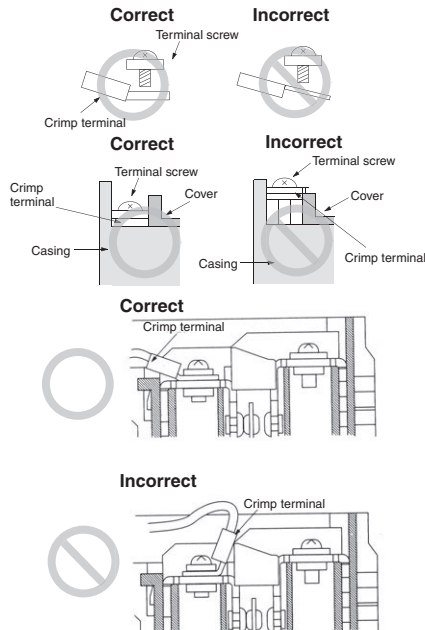

**Conduit Opening**

- Make sure that each connector is tightened within the specified torque range.  
 The casing may be damaged if the connector is tightened excessively.
- Use an OMRON SC-series Connector (sold separately) that is suited to the cable in diameter.

**Others**

- The load for the actuator (roller) of the Switch must be imposed on the actuator in the horizontal direction, otherwise the actuator or the rotating axis may be deformed or damaged.

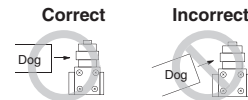

- When using a long lever model, the D4B-□□16N or D4B-□□17N, the Switch may telegraph. To avoid telegraphing, take the following precautions.

1. Set the lever to operate in one direction.
2. Modify the rear end of the dog to an angle of 15° to 30° as shown below or to a secondary-degree curve.

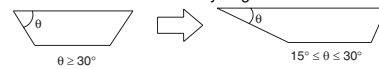

3. Modify the circuit so as not to detect the wrong operating signals.

#### Read and Understand This Catalog

Please read and understand this catalog before purchasing the products. Please consult your OMRON representative if you have any questions or comments.

#### Warranty and Limitations of Liability

##### WARRANTY

OMRON's exclusive warranty is that the products are free from defects in materials and workmanship for a period of one year (or other period if specified) from date of sale by OMRON.

OMRON MAKES NO WARRANTY OR REPRESENTATION, EXPRESS OR IMPLIED, REGARDING NON-INFRINGEMENT, MERCHANTABILITY, OR FITNESS FOR PARTICULAR PURPOSE OF THE PRODUCTS. ANY BUYER OR USER ACKNOWLEDGES THAT THE BUYER OR USER ALONE HAS DETERMINED THAT THE PRODUCTS WILL SUITABLY MEET THE REQUIREMENTS OF THEIR INTENDED USE. OMRON DISCLAIMS ALL OTHER WARRANTIES, EXPRESS OR IMPLIED.

##### LIMITATIONS OF LIABILITY

OMRON SHALL NOT BE RESPONSIBLE FOR SPECIAL, INDIRECT, OR CONSEQUENTIAL DAMAGES, LOSS OF PROFITS OR COMMERCIAL LOSS IN ANY WAY CONNECTED WITH THE PRODUCTS, WHETHER SUCH CLAIM IS BASED ON CONTRACT, WARRANTY, NEGLIGENCE, OR STRICT LIABILITY.

In no event shall the responsibility of OMRON for any act exceed the individual price of the product on which liability is asserted.

IN NO EVENT SHALL OMRON BE RESPONSIBLE FOR WARRANTY, REPAIR, OR OTHER CLAIMS REGARDING THE PRODUCTS UNLESS OMRON'S ANALYSIS CONFIRMS THAT THE PRODUCTS WERE PROPERLY HANDLED, STORED, INSTALLED, AND MAINTAINED AND NOT SUBJECT TO CONTAMINATION, ABUSE, MISUSE, OR INAPPROPRIATE MODIFICATION OR REPAIR.

#### Application Considerations

##### SUITABILITY FOR USE

OMRON shall not be responsible for conformity with any standards, codes, or regulations that apply to the combination of products in the customer's application or use of the products.

At the customer's request, OMRON will provide applicable third party certification documents identifying ratings and limitations of use that apply to the products. This information by itself is not sufficient for a complete determination of the suitability of the products in combination with the end product, machine, system, or other application or use.

The following are some examples of applications for which particular attention must be given. This is not intended to be an exhaustive list of all possible uses of the products, nor is it intended to imply that the uses listed may be suitable for the products:

- Outdoor use, uses involving potential chemical contamination or electrical interference, or conditions or uses not described in this catalog.
- Nuclear energy control systems, combustion systems, railroad systems, aviation systems, medical equipment, amusement machines, vehicles, safety equipment, and installations subject to separate industry or government regulations.
- Systems, machines, and equipment that could present a risk to life or property.

Please know and observe all prohibitions of use applicable to the products.

NEVER USE THE PRODUCTS FOR AN APPLICATION INVOLVING SERIOUS RISK TO LIFE OR PROPERTY WITHOUT ENSURING THAT THE SYSTEM AS A WHOLE HAS BEEN DESIGNED TO ADDRESS THE RISKS, AND THAT THE OMRON PRODUCTS ARE PROPERLY RATED AND INSTALLED FOR THE INTENDED USE WITHIN THE OVERALL EQUIPMENT OR SYSTEM.

##### PROGRAMMABLE PRODUCTS

OMRON shall not be responsible for the user's programming of a programmable product, or any consequence thereof.

#### Disclaimers

##### CHANGE IN SPECIFICATIONS

Product specifications and accessories may be changed at any time based on improvements and other reasons.

It is our practice to change model numbers when published ratings or features are changed, or when significant construction changes are made. However, some specifications of the products may be changed without any notice. When in doubt, special model numbers may be assigned to fix or establish key specifications for your application on your request. Please consult with your OMRON representative at any time to confirm actual specifications of purchased products.

##### DIMENSIONS AND WEIGHTS

Dimensions and weights are nominal and are not to be used for manufacturing purposes, even when tolerances are shown.

##### PERFORMANCE DATA

Performance data given in this catalog is provided as a guide for the user in determining suitability and does not constitute a warranty. It may represent the result of OMRON's test conditions, and the users must correlate it to actual application requirements. Actual performance is subject to the OMRON Warranty and Limitations of Liability.

##### ERRORS AND OMISSIONS

The information in this document has been carefully checked and is believed to be accurate; however, no responsibility is assumed for clerical, typographical, or proofreading errors, or omissions.

2012.10

In the interest of product improvement, specifications are subject to change without notice.

**OMRON Corporation**  
Industrial Automation Company  
<http://www.ia.omron.com/>

(c)Copyright OMRON Corporation 2012 All Right Reserved.