

## Datenblatt

### Spannungsüberwachungsrelais K8DS-PM

K8DS-PM



<b>Bezeichnung</b>	K8DS-PM
<b>Einstellzeit</b>	0,1 - 30 s
<b>Schutzgrad</b>	IP20
<b>Betriebstemperatur</b>	-20°C ... +60°C
<b>Zertifizierung</b>	EN 60647-5-1, UL 508, CSA, CCC
<b>Versorgungsspannung</b>	200 - 240VAC, 380 - 480 VAC
<b>Max. Schaltstrom</b>	5 A
<b>Anzahl Kontakte</b>	1 Wechsler
<b>Kategorie</b>	Phasenlage , Phasenausfall, Über- und Unterspannung
<b>Überwachungsbereich</b>	identisch mit Versorgungsspannung
<b>Anschlusstyp</b>	Schraubklemmen
<b>Art</b>	Dreiphasig Spannung
<b>Regelausgang</b>	Relais (1 Wechsler)

New Product News



# Measuring & Monitoring Relays K8AK/K8DS Series

## DIN 22.5/17.5 Size Lineup of A Wide Range of Measuring and Monitoring Relays

- Compact 22.5 mm and 17.5 mm housings
- Resistant to high-frequency noise
- Compliance with global power and safety standards



### Model Number Structure

#### Model Number Legend

K8AK-□□  
1 2

1. **Function**

- AS: Single-phase Current Relay
- AW: Single-phase Overcurrent/Undercurrent Relays
- VS: Single-phase Voltage Relay
- VW: Single-phase Overvoltage/Undervoltage Relays
- PH: Phase-sequence Phase-loss Relay
- PW: Three-phase Voltage Relay
- PM: Three-phase Phase-sequence Phase-loss Relay
- PA: Three-phase Asymmetry and Phase-sequence Phase-loss Relay
- TH: Temperature Monitoring Relay
- LS: Conductive Level Controller

2. **Supply Voltage**

Refer to *Ordering Information* for the relevant model.

**Note:** Models are also available with fixed set values. Consult with your OMRON representative for conditions.

Models with fixed set values are available for the following models: K8AK-AS, K8AK-AW, K8AK-VS, K8AK-VW, K8AK-PM, K8AK-PA, K8AK-PW, and K8AK-LS.

K8DS-□□  
1 2

1. **Function**

- PH: Phase-sequence Phase-loss Relay

2. **Setting range**

- 1: One SPDT relay output

**K8AK Series**

**Measuring & Monitoring Relay K8AK/K8DS series selection guide**

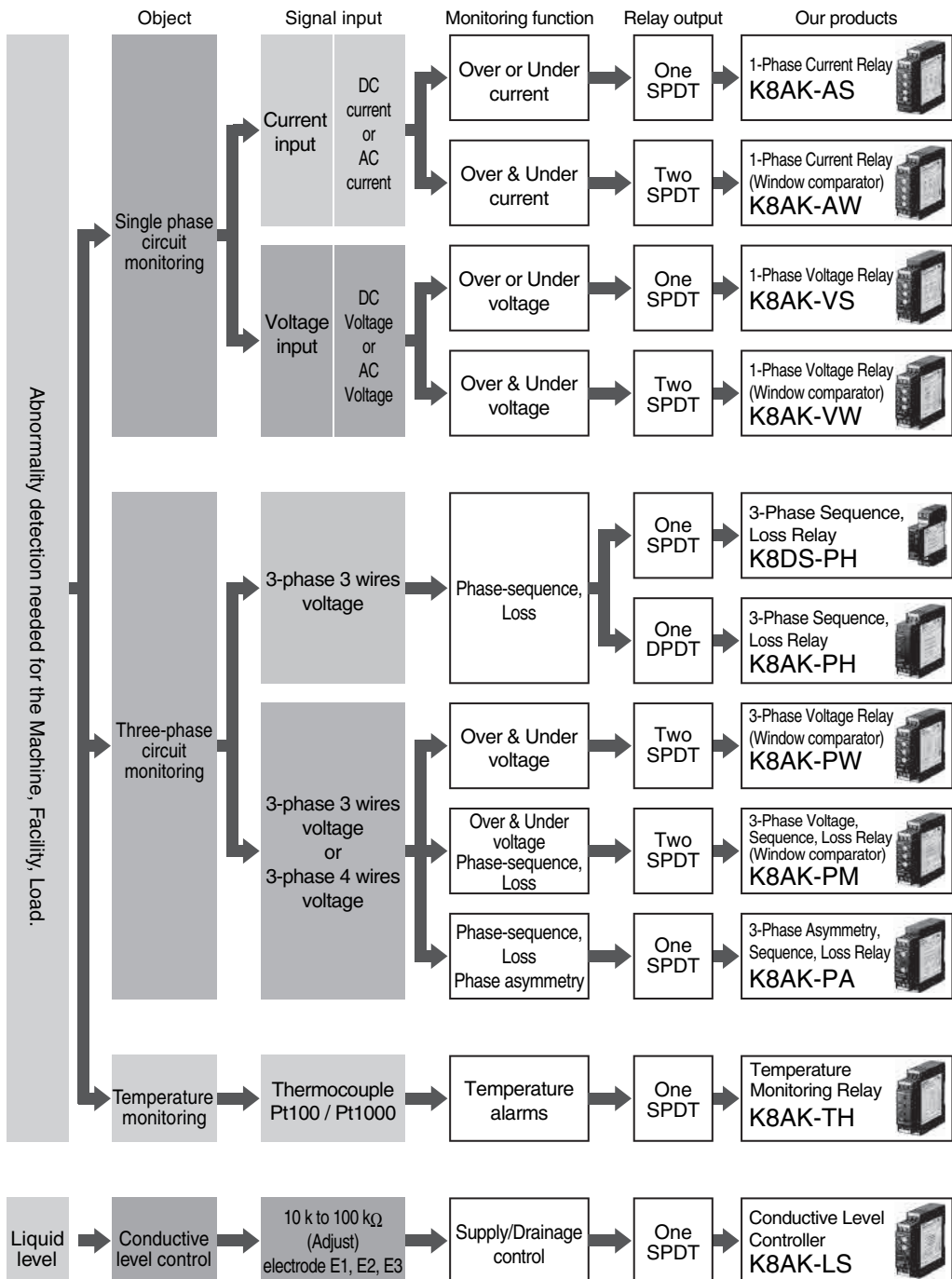

K8AK Series

Application examples

**K8AK-AS**

**● Purpose**  
When the motor locks, its rotational torque may break the chain. To prevent that from happening, the relay must trip the instant it detects a motor lock error. A thermal relay cannot be used for chain protection because it takes too long to start operating.

**● Advantages**  
The K8AK-AS offers effective chain protection because it starts operating in 0.1 s or less.

**K8AK-AW**

**● Purpose**  
A monitor of the overcurrent of a submersible pump and the undercurrent is needed.

**● Advantages**  
K8AK-AW can monitor the overcurrent and the undercurrent at the same time with a single K8AK-AW.

**K8AK-VS**

**● Purpose**  
The K8AK-VS is used to check battery charge levels of the equipment engine booting.

**● Advantages**  
The K8AK-VS can detect when the battery charge is low.

**K8AK-VW**

**● Purpose**  
Control panel must be carefully monitored because the effects of a power outage or voltage drop would be highly detrimental to equipment. The K8AK-VW monitors the control power supply for overvoltage and undervoltage levels.

**● Advantages**  
Overvoltage and undervoltage can be detected with a single K8AK-VW. It can also output individual overvoltage and undervoltage alarms using SPDT relays, and can provide a pre-alarm warning output to eliminate system downtime.

**K8DS-PH**

**● Purpose**  
The K8DS-PH detects phase-sequence or phase-loss errors in molding machine/machine tool power supplies.

**● Advantages**  
K8DS-PH is small, so it can be compactly installed.

**K8AK-PH**

**● Purpose**  
The K8AK-PH detects phase-sequence or phase-loss errors in escalator/ elevator power supplies.

**● Advantages**  
An output relay of K8AK-PH is 2c output. That it's for control, it's possible to classify and use one for warnings.

### K8AK Series

#### Application examples

#### K8AK-PW

Wind-power generator

Generator

- **Purpose**  
The K8AK-PW detects overvoltage and undervoltage in power generated by a power generator
- **Advantages**  
A single K8AK-PW can be used for a three-phase power supply with three or four wires. It can be used to individually set and output overvoltage and undervoltage alarms.

#### K8AK-PM

- **Purpose**  
Cranes cannot operate correctly when there is an overvoltage and undervoltage, or a phase-sequence or phase-loss error. The K8AK-PM can be used to monitor three-phase voltage, phase-sequence, and phase-loss errors.
- **Advantages**  
A single K8AK-PM can monitor overvoltage and undervoltage, as well as phase-sequence and phase-loss errors in three-phase voltage. It can also output individual alarms for overvoltage or undervoltage using SPDT relays. This makes it possible to determine which type of error occurred.

#### K8AK-PA

Fixed compressors

Mobile compressors

- **Purpose**  
Compressors cannot operate correctly when there is a phase-sequence, or a phase asymmetry or phase-loss error.
- **Advantages**  
A single K8AK-PA can monitor voltage unbalance, as well as phase-sequence, and phase-loss errors in three-phase voltage.

#### K8AK-TH

- **Purpose**  
K8AK-TH is used for overtemperature prevention of heater and abnormal temperature monitoring.
- **Advantages**  
K8AK-TH is the slim type by DIN rail installation, so it's most suitable for the warning use. Temperature setting can be established easily by the rotary switch.

#### K8AK-LS

K8AK-LS Conductive level control

- **Purpose**  
The K8AK-LS can be used to control the liquid level in a tank.
- **Advantages**  
Because the sensitivity resistance can be adjusted from 10 k to 100 kΩ, there is no need to change models to match different liquid types and concentrations. You can also set the operation time in a range of 0.1 to 10 seconds to prevent operating errors due to chattering. Water supply and draining control can be changed by DIP switch.



# Single-phase Current Relay K8AK-AS

**Ideal for current monitoring for industrial facilities and equipment.**

- Monitor for overcurrents or undercurrents.
- Use commercially available CTs (CT current on secondary side: 0 to 1 A or 0 to 5 A).
- Manual resetting and automatically resetting supported by one Relay.
- Startup lock and operating time can be set separately.
- One SPDT output relay, 5 A at 250 VAC (resistive load).
- Output relay can be switched between normally open and normally closed.
- Output status can be monitored using LED indicator.
- Inputs are isolated from the power supply.
- RoHS-compliant.

⚠ Refer to *Safety Precautions for the K8AK Series* on page 86. Refer to page 13 for commonly asked questions.



For the most recent information on models that have been certified for safety standards, refer to your OMRON website.

## Ordering Information

### List of Models

Setting range	Supply voltage	Model
2 to 20 mA AC/DC, 10 to 100 mA AC/DC, 50 to 500 mA AC/DC	24 VAC/DC	<b>K8AK-AS1 24 VAC/DC</b>
	100 to 240 VAC	<b>K8AK-AS1 100-240 VAC</b>
0.1 to 1 A AC/DC, 0.5 to 5 A AC/DC, 0.8 to 8 A AC/DC	24 VAC/DC	<b>K8AK-AS2 24 VAC/DC</b>
	100 to 240 VAC	<b>K8AK-AS2 100-240 VAC</b>
10 to 100 A AC*, 20 to 200 A AC*	24 VAC/DC	<b>K8AK-AS3 24 VAC/DC</b>
	100 to 240 VAC	<b>K8AK-AS3 100-240 VAC</b>

\*1 The K8AK-AS3 is designed to be used in combination with an OMRON K8AC-CT200L Current Transformer (CT). (Direct input is not possible.)

### Accessory (Order Separately)

#### ●OMRON CT

Appearance	Input range	Applicable Relay	Model
	10 to 100 A AC, 20 to 200 A AC	K8AK-AS3	<b>K8AC-CT200L</b>

#### ●Commercially Available CTs\*

Appearance	CT current on secondary side	Applicable Relay
	0 to 1 A AC, 0 to 5 A AC	K8AK-AS2

\* If you use a commercially available CT, do not exceed the overload capacity of the K8AK-AS2.

## K8AK-AS

### Ratings and Specifications

#### Input Range

Model	Range <sup>*1</sup>	Connection terminal	Setting range	Input impedance	Input type	Overload capacity
K8AK-AS1	0 to 20 mA AC/DC	I1-COM	2 to 20 mA AC/DC, 10 to 100 mA AC/ DC, 50 to 500 mA AC/DC	Approx. 5 Ω	Direct input	Continuous input at 120% of maximum input 1 s at 150%
	0 to 100 mA AC/DC	I2-COM		Approx. 1 Ω	Direct input	
	0 to 500 mA AC/DC	I3-COM		Approx. 0.2 Ω	Direct input	
K8AK-AS2	0 to 1 A AC/DC	I1-COM	0.1 to 1 A AC/DC, 0.5 to 5 A AC/DC, 0.8 to 8 A AC/DC	Approx. 0.12 Ω (Load : 0.5 VA)	Direct input or commercially available CT	
	0 to 5 A AC/DC	I2-COM		Approx. 0.02 Ω (Load : 1.5 VA)	---	
	0 to 8 A AC/DC	I3-COM		Approx. 0.02 Ω (Load : 3 VA)	---	
K8AK-AS3	0 to 100 A AC	I2-COM	10 to 100 A AC <sup>*2</sup> , 20 to 200 A AC <sup>*2</sup>	---	OMRON CT	Continuous input at 120% with an OMRON CT (K8AC- CT200L). 30 s at 200% 1 s at 600% * CT capacity on primary side.
	0 to 200 A AC	I3-COM		---	OMRON CT	

\*1 The range is selected using connected terminals.

\*2 The K8AK-AS3 is designed to be used in combination with an OMRON K8AC-CT200L Current Transformer (CT). (Direct input is not possible.)

#### Ratings

Power supply voltage	Isolated power supply	24 VAC/DC 100 to 240 VAC
Power consumption		24 VAC/DC: 2.0 VA/1.1 W max. 100 to 240 VAC: 4.6 VA max.
Operating value setting range (SV)		10% to 100% of the maximum value of the setting range K8AK-AS1: 2 to 20 mA AC/DC 10 to 100 mA AC/DC 50 to 500 mA AC/DC K8AK-AS2: 0.1 to 1 A AC/DC (Compatible with commercially available CTs.) 0.5 to 5 A AC/DC (Compatible with commercially available CTs.) 0.8 to 8 A AC/DC K8AK-AS3: When used with the OMRON CT (K8AC-CT200L). 10 to 100 A AC 20 to 200 A AC
Operating value		100% operation at set value
Reset value setting range (HYS.)		5% to 50% of operating value
Reset method		Manual reset/automatic reset (switchable) <b>Note:</b> Manual reset: Turn OFF power supply for 1 s or longer.
Operating time setting range (T)		0.1 to 30 s
Startup lock time setting range (LOCK)		0 to 30 s (The startup lock timer starts when the input has reached approximately 30% or more of the set value.) <b>Note:</b> Enabled only for overcurrent operation.
Indicators		Power (PWR): Green, Relay output (RY): Yellow, Alarm outputs (ALM): Red
Input impedance		Refer to <i>Input Range</i> on this page.
Output relays		One SPDT relay (NO/NC switched using DIP switch.)
Output relay ratings		Rated load Resistive load 5 A at 250 VAC 5 A at 30 VDC Maximum contact voltage: 250 VAC or 30 VDC Max. switching current: 5 A Maximum switching capacity: 1,250 VA, 150 W Mechanical life: 10 million operations min. Electrical life: 5 A at 250 VAC or 30 VDC: 50,000 operations 3 A at 250 VAC/30 VDC: 100,000 operations
Ambient operating temperature		-20 to 60°C (with no condensation or icing)
Storage temperature		-25 to 65°C (with no condensation or icing)
Ambient operating humidity		25% to 85% (with no condensation)
Storage humidity		25% to 85% (with no condensation)
Altitude		2,000 m max.
Terminal screw tightening torque		0.49 N·m



### K8AK-AS

<b>Terminal wiring method</b>	Recommended wire Solid wire: 2.5 mm <sup>2</sup> Twisted wires: AWG16, AWG18 <b>Note:</b> 1. Ferrules with insulating sleeves must be used with twisted wires. 2. Two wires can be twisted together. Recommended ferrules Al 1,5-8BK (for AWG16) manufactured by Phoenix Contact Al 1-8RD (for AWG18) manufactured by Phoenix Contact Al 0,75-8GY (for AWG18) manufactured by Phoenix Contact
<b>Case color</b>	N1.5
<b>Case material</b>	PC and ABS
<b>Weight</b>	Approx. 150 g
<b>Mounting</b>	Mounts to DIN Track
<b>Dimensions</b>	22.5 × 90 × 100 mm (W×H×D)

### Specifications

<b>Allowable operating voltage range</b>	85% to 110% of power supply voltage	
<b>Allowable operating frequency range</b>	50/60 Hz ±5 Hz	
<b>Input frequency range</b>	K8AK-AS1 and K8AK-AS2: DC input or AC input (45 to 65 Hz) K8AK-AS3: AC input (45 to 65 Hz)	
<b>Overload capacity</b>	K8AK-AS1 and K8AK-AS2: Continuous input at 120% of maximum input, 1 s at 150% K8AK-AS3: Continuous input at 120%, 30 s at 200%, and 1 s at 600% with an OMRON CT (K8AC-CT200L) <b>Note:</b> Overload capacity of primary side of CT.	
<b>Repeat error</b>	<b>Operating value</b>	±0.5% full scale (at 25°C and 65% humidity, rated power supply voltage, DC or 50/60 Hz sine wave input)
	<b>Operating time</b>	±50 ms (at 25°C and 65% humidity, rated power supply voltage)
<b>Applicable standards</b>	<b>Conforming standards</b>	EN60947-5-1 Installation environment (pollution level 2, installation category III)
	<b>EMC</b>	EN60947-5-1
	<b>Safety standards</b>	UL 508 (Recognition), Korean Radio Waves Act (Act 10564), CSA: CAN/CSA C22.2 No.14, CCC: GB14048.5
<b>Insulation resistance</b>	20 MΩ min. Between external terminals and case Between power supply terminals and input terminals Between power supply terminals and output terminals Between input terminals and output terminals	
<b>Dielectric strength</b>	2,000 VAC for one minute Between external terminals and case Between power supply terminals and input terminals Between power supply terminals and output terminals Between input terminals and output terminals	
<b>Noise immunity</b>	1,500 V power supply terminal common/normal mode Square-wave noise of ±1 μs/100 ns pulse width with 1-ns rise time	
<b>Vibration resistance</b>	Frequency 10 to 55 Hz, 0.35-mm single amplitude, acceleration 50 m/s <sup>2</sup> 10 sweeps of 5 min each in X, Y, and Z directions	
<b>Shock resistance</b>	150 m/s <sup>2</sup> , 3 times each in 6 directions along 3 axes Or 100 m/s <sup>2</sup> for relay contacts.	
<b>Degree of protection</b>	Terminals: IP20	

K8AK-AS

● Relationship of Mounting Distance between K8AK-AS Relays and Input Current (Reference Values)

The following diagram shows the relationship between the mounting distances and the input current. If the relay is used with an input current that exceeds these values, the temperature of the K8AK may rise and shorten the life of the internal components.

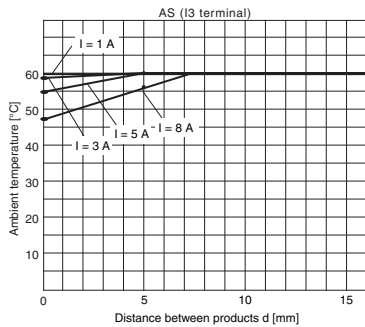

Test method

Sample: K8AK-AS  
Applied voltage: 240 VAC  
Mounting distances: 0, 5, and 10 mm min.

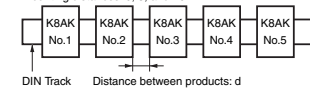

Connections

Wiring Diagram

● Overcurrent Operation Diagram (Output Relay Drive Method: Normally Open)

DIP switch setting: SW3 OFF.

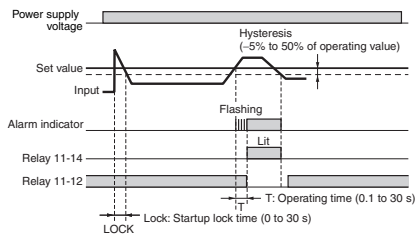

● Undercurrent Operation Diagram (Output Relay Drive Method: Normally Closed)

DIP switch setting: SW3 ON.

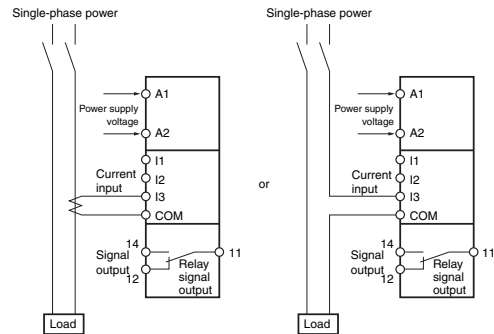
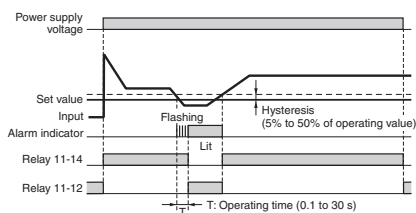

- Note: 1. The K8AK-AS3 is designed to be used in combination with the OMRON K8AC-CT200L Current Transformer (CT).
- 2. There is no polarity when a DC current input is used.
- 3. Refer to the *Setting Ranges and Wiring Connections* as the explanation of current input I1, I2, and I3 terminal.

**K8AK-AS**

**Nomenclature**

**Front**

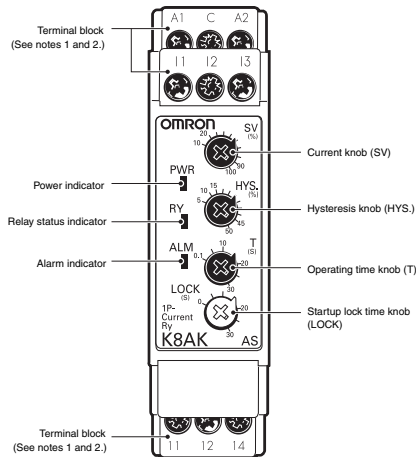

**●Indicators**

Item	Meaning
Power indicator (PWR: Green)	Lit when power is being supplied.
Relay status indicator (RY: Yellow)	Lit when relay is operating.
Alarm indicator (ALM: Red)	Lit when there is an overcurrent or undercurrent. The indicator flashes to indicate the error status after the input has exceeded the set value while the operating time is being clocked.

**●Setting Knobs**

Item	Usage
Current knob (SV)	Used to set the current to 10% to 100% of maximum setting range.
Hysteresis knob (HYS.)	Used to set the rest value to 5% to 50% of the operating value.
Operating time knob (T)	Used to set the operating time to 0.1 to 30 s.
Startup lock time knob (LOCK)	Used to set the startup lock time to 0 to 30 s.

**Note: 1.** Use either a solid wire of 2.5 mm<sup>2</sup> maximum or a ferrule with insulating sleeve for the terminal connection. The length of the exposed current-carrying part inserted into the terminal must be 8 mm or less to maintain dielectric strength after connection.

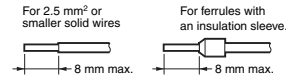

**Recommended ferrules**

Phoenix Contact

- Al 1,5-8BK (for AWG16)
- Al 1-8RD (for AWG18)
- Al 0,75-8GY (for AWG18)

2. Tightening torque: 0.49 N·m

K8AK-AS

Operation and Setting Methods

●Setting Ranges and Wiring Connections

Model	Setting range	Input type	Wiring connections
K8AK-AS1	2 to 20 mA AC/DC	Direct input	I1-COM
	10 to 100 mA AC/DC	Direct input	I2-COM
	50 to 500 mA AC/DC	Direct input	I3-COM
K8AK-AS2	0.1 to 1 A AC/DC	Direct input or commercially available CT	I1-COM
	0.5 to 5 A AC/DC		I2-COM
	0.8 to 8 A AC/DC	---	I3-COM
K8AK-AS3	10 to 100 A AC*	OMRON CT	I2-COM
	20 to 200 A AC*	OMRON CT	I3-COM

**Note:** The DC input terminals have no polarity.  
 \* The K8AK-AS3 is designed to be used in combination with the OMRON K8AC-CT200L Current Transformer (CT). (Direct input is not possible.)

●Connections

- 1. Input**  
 Connect the input between the I1-COM, I2-COM, or I3-COM terminals, according to the input current. Malfunctions may occur if the input is connected to unused terminals and the Unit will not operate correctly.  
 Terminal I1 is not used by the K8AK-AS3.  
 If using the OMRON K8AC-CT200L CT, connect to terminals k and l on the K8AC-CT200L. (Terminals kt and lt are not used.)
- 2. Power Supply**  
 Connect the power supply to terminals A1 and A2.
- 3. Outputs**  
 Terminals 11, 12, and 14 are the output terminals (SPDT) for overvoltage.  
**Note:** Use the recommended ferrules if using twisted wires.

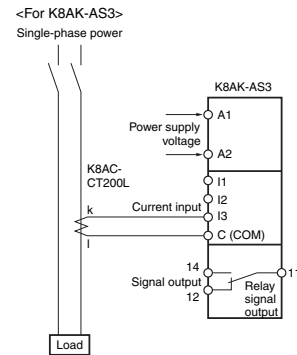

●DIP Switch Settings

The resetting method, relay drive method, and operating mode are set using the DIP switch located on the bottom of the Unit.  
 K8AK-AS□ does not use SW1.

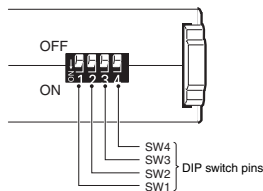

DIP Switch Functions

Pin	OFF ● ↑	OFF 1	2	3	4
	ON ○ ↓	ON			
Resetting method	Manual reset	●	---	---	---
	Automatic reset	○	---	---	---
Relay drive method	Normally open	---	●	---	---
	Normally closed	---	---	○	---
Operating mode	Overcurrent	---	---	---	●
	Undercurrent	---	---	---	○

**Note:** All pins are set to OFF by default.

●Setting Method

- 1. Setting Current**  
 The current knob (SV) is used to set the current.  
 The current can be set to 10% to 100% of the maximum setting range.  
 Turn the knob while there is an input to the input terminals until the alarm indicator flashes (when the set value and the input have reached the same level.)  
 Use this as a guide to set the current.  
 The maximum setting range will differ depending on the model and the input terminal.  
 Example: K8AK-AS3 Using Input Terminals I3-COM  
 The maximum setting range will be 200 A AC and the setting range will be 20 to 200 A.
- 2. Hysteresis**  
 Hysteresis is set using the hysteresis knob (HYS.)  
 The setting range is 5 to 50% of the operating value.  
 Turn the knob while there is an input to the input terminals until the alarm indicator flashes (when the set value and the input have reached the same level.)  
 Use this as a guide to set the hysteresis.

**K8AK-AS**

Example: Maximum of 200 A AC, Current Set Value (SV) of 50%, and Overcurrent Operation Operation will be at 100 A and resetting at 90 A when the hysteresis (HYS.) is set to 10%.

**3. Operating Time**

The operating time is set using the operating time knob (T).

The operating time can be set to between 0.1 and 30 s.

Turn the knob while there is an input to the input terminals until the alarm indicator flashes (when the set value and the input have reached the same level.)

Use this as a guide to set the operating time.

If the input current exceeds (drops lower than) the set value, the alarm indicator will start flashing for the set period and then stay lit.

**4. Startup Lock Time**

The startup lock time is set using the startup lock time knob (LOCK).

The startup lock time can be set to between 0 and 30 s.

Turn the knob while there is an input to the input terminals until the alarm indicator flashes (when the set value and the input have reached the same level.)

Use this as a guide to set the startup lock time.

The startup lock time will start when the input current reaches 30% or more of the set value.

Use startup lock time to prevent unwanted operation, e.g., as a result of inrush current.

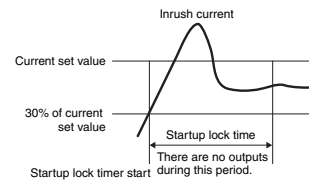

**Dimensions (Unit: mm)**

**●Single-phase Current Relays**

- K8AK-AS1
- K8AK-AS2
- K8AK-AS3

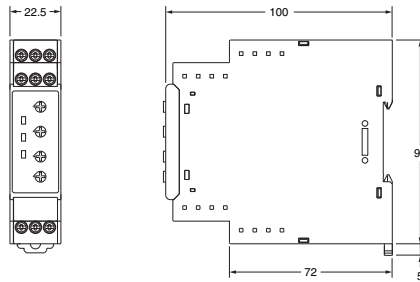

**●OMRON CT**

- K8AC-CT200L

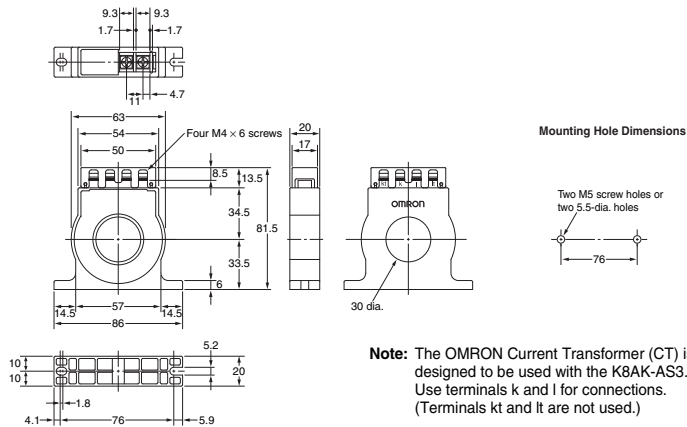

**Optional Parts for DIN Track Mounting**

**●DIN Tracks**

- PPF-100N
- PPF-50N

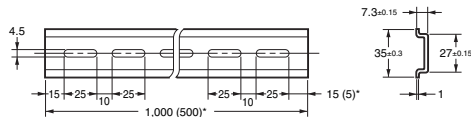
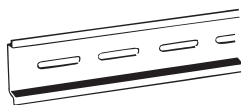

\*Dimensions in parentheses are for the PPF-50N.

K8AK-AS

Questions and Answers

**Q** Checking Operation

**A** Overcurrents  
Gradually increase the input from 80% of the set value. The input will equal the operating value when the input exceeds the set value and the alarm indicator starts flashing. Operation can be checked by the relay outputs that will start after the operating time has passed.

Undercurrent  
Gradually decrease the input from 120% of the setting and check the operation using the same method as for overcurrent.

Example: Overcurrent Operating Mode, Normally Open Relay Drive, and an Operating Time of 5 s

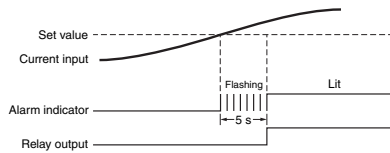

Connection Diagram

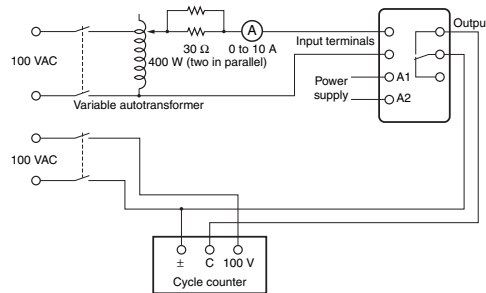

**Q** How to Measure the Operating Time

**A** Overcurrent  
Change the input suddenly from 0% to 120% of the set value and measure the time until the Unit operates.

Undercurrent  
Change the input suddenly from 120% to 0% of the set value and measure the time until the Unit operates.

**Q** Monitoring Switch-mode Power Supplies

**A** Switch-mode Power Supplies cannot be monitored. In circuits with a capacitor input, including switch-mode power supplies, the input capacitor recharge current flows in pulse form as the load current. The K8AK-AS□ has a built-in filter as a countermeasure against high frequencies and cannot be used to remove pulse current.

**Q** Can a motor with a rated current of 5 A be monitored using the K8AK?  
Are there any application precautions?

**A** The K8AK-AS1 and K8AK-AS2 cannot be used with motor loads. Use the K8AK-AS3 in combination with the K8AC-CT200L Current Transformer (CT). With motor loads, the startup current and stall current will cause a current of many times the rated current to flow. Refer to the following figure for information on the motor startup current.

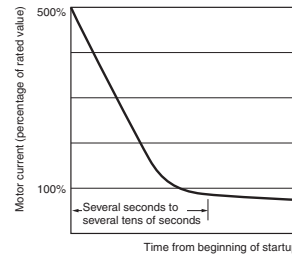

For a motor with a rating of 5 A, the startup current will be approximately 30 A. The startup current will exceed the overload capacity (rating: 150% for 1 s) of the K8AK-AS1 and K8AK-AS2 and result in failure of the Relay. To monitor the motor load, use the K8AK-AS3. (Overload capacity: 120% of rating for continuous load, 200% of rating for 30 s, and 600% of rating for 1 s). The K8AK-AS3 has a large input range. Pass the conductors multiple times through the special CT.

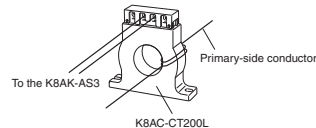

Concept behind Passing Conductor through the CT When Using the K8AK-AS3

Example: Monitoring Overload of a Motor with a Rated Current of 5 A  
K8AK set value:  
Overcurrent detection, operating value setting: 25%, operating time: 0.1 s  
Startup lock timer: 0.1 to 30 s (Set the timer according to the duration of the startup current.)

The setting range for the K8AK-AS3 is 10% to 100% of the rated current (i.e., 10 to 100 A). Pass the conductors through the CT five times so that at least 10 A of current flows. The input current to the K8AK will be 25 A (i.e., 5 A x 5 loops).  
If a startup current of six times the rated current is generated, it will be 150 A (i.e., 25 A x 6). The overload capacity for the K8AK-AS3 is 200% of the rating for 30 s. The Relay will not fail even if the startup current continues for 30 s, and it is possible to perform overload detection.

# Single-phase Overcurrent/Undercurrent Relays K8AK-AW

Ideal for current monitoring for industrial facilities and equipment.

- Monitor for overcurrents and undercurrents simultaneously. Separate settings and outputs supported for overcurrents and undercurrents.
- Use commercially available CTs (CT current on secondary side: 0 to 1 A or 0 to 5 A).
- Manual resetting and automatically resetting supported by one Relay.
- Startup lock and operating time can be set separately.
- Two sets of SPDT output contacts, 5 A at 250 VAC (resistive load).
- Output status can be monitored using LED indicator.
- Inputs are isolated from the power supply.
- RoHS-compliant.



For the most recent information on models that have been certified for safety standards, refer to your OMRON website.

Refer to *Safety Precautions for the K8AK Series* on page 86. Refer to page 22 for commonly asked questions.

## Ordering Information

### List of Models

Setting range	Supply voltage	Model
2 to 20 mA AC/DC	24 VAC/DC	<b>K8AK-AW1 24 VAC/DC</b>
10 to 100 mA AC/DC	100 to 240 VAC	<b>K8AK-AW1 100-240 VAC</b>
50 to 500 mA AC/DC		
0.1 to 1 A AC/DC	24 VAC/DC	<b>K8AK-AW2 24 VAC/DC</b>
0.5 to 5 A AC/DC	100 to 240 VAC	<b>K8AK-AW2 100-240 VAC</b>
10 to 100 A AC*	24 VAC/DC	<b>K8AK-AW3 24 VAC/DC</b>
20 to 200 A AC*	100 to 240 VAC	<b>K8AK-AW3 100-240 VAC</b>

\* The K8AK-AW3 is designed to be used in combination with an OMRON K8AC-CT200L Current Transformer (CT). (Direct input is not possible.)

### Accessory (Order Separately)

#### ●OMRON CT

Appearance	Input range	Applicable Relay	Model
	10 to 100 A AC, 20 to 200 A AC	K8AK-AW3	<b>K8AC-CT200L</b>

#### ●Commercially Available CTs\*

Appearance	CT current on secondary side	Applicable Relay
	0 to 1 A AC, 0 to 5 A AC	K8AK-AW2

\* If you use a commercially available CT, do not exceed the overload capacity of the K8AK-AW2.

**K8AK-AW**

**Ratings and Specifications**

**Input Range**

Model	Range <sup>*1</sup>	Connection terminals	Setting range	Input impedance	Input type	Overload capacity
K8AK-AW1	0 to 20 mA AC/DC	I1-COM	2 to 20 mA AC/DC	Approx. 5 Ω	Direct input	Continuous input at 120% of maximum input. 1 s at 150%
	0 to 100 mA AC/DC	I2-COM	10 to 100 mA AC/DC	Approx. 1 Ω	Direct input	
	0 to 500 mA AC/DC	I3-COM	50 to 500 mA AC/DC	Approx. 0.2 Ω	Direct input	
K8AK-AW2	0 to 1 A AC/DC	I1-COM	0.1 to 1 A AC/DC	Approx. 0.12 Ω (Load: 0.5 VA)	Direct input or commercially available CT	
	0 to 5 A AC/DC	I2-COM	0.5 to 5 A AC/DC	Approx. 0.02 Ω (Load: 1.5 VA)		
K8AK-AW3	0 to 100 A AC	I2-COM	10 to 100 A AC <sup>*2</sup> 20 to 200 A AC <sup>*2</sup>	---	OMRON CT	
	0 to 200 A AC	I3-COM		---	OMRON CT	

\*1 The range is selected using connected terminals.

\*2 The K8AK-AW3 is designed to be used in combination with an OMRON K8AC-CT200L Current Transformer (CT). (Direct input is not possible.)



## K8AK-AW

### Ratings

<b>Power supply voltage</b>	<b>Isolated power supply</b>	24 VAC/DC 100 to 240 VAC
<b>Power consumption</b>		24 VAC/DC: 2.0 VA/1.1 W max. 100 to 240 VAC: 4.6 VA max.
<b>Operating value setting range (SV)</b>		10% to 100% of the maximum value of the setting range K8AK-AW1: 2 to 20 mA AC/DC 10 to 100 mA AC/DC 50 to 500 mA AC/DC K8AK-AW2: 0.1 to 1 A AC/DC (Compatible with commercially available CTs.) 0.5 to 5 A AC/DC (Compatible with commercially available CTs.) K8AK-AW3: When used with the OMRON CT (K8AC-CT200L). 10 to 100 A AC 20 to 200 A AC
<b>Operating value</b>		100% operation at set value
<b>Reset value</b>		5% of operating value (fixed)
<b>Reset method</b>		Manual reset/automatic reset (switchable) <b>Note:</b> Manual reset: Turn OFF power supply for 1 s or longer.
<b>Operating time setting range (T)</b>		0.1 to 30 s
<b>Startup lock time setting range (LOCK)</b> <b>Note:</b> Enabled only for overcurrent operation.		0 to 30 s (The startup lock timer starts when the input has reached approximately 30% or more of the set value.) <b>Note:</b> Enabled only for overcurrent operation.
<b>Indicators</b>		Power (PWR): Green, Relay output (RY): Yellow, Alarm outputs (ALM): Red
<b>Input impedance</b>		Refer to <i>Input Range</i> on previous page.
<b>Output relays</b>		Two SPDT relay outputs (normally closed operation)
<b>Output relay ratings</b>		Rated load Resistive load 5 A at 250 VAC 5 A at 30 VDC Maximum contact voltage: 250 VAC or 30 VDC Max. switching current: 5 A Maximum switching capacity: 1,250 VA, 150 W Mechanical life: 10 million operations min. Electrical life: 5 A at 250 VAC or 30 VDC: 50,000 operations 3 A at 250 VAC/30 VDC: 100,000 operations
<b>Ambient operating temperature</b>		-20 to 60°C (with no condensation or icing)
<b>Storage temperature</b>		-25 to 65°C (with no condensation or icing)
<b>Ambient operating humidity</b>		25% to 85% (with no condensation)
<b>Storage humidity</b>		25% to 85% (with no condensation)
<b>Altitude</b>		2,000 m max.
<b>Terminal screw tightening torque</b>		0.49 N·m
<b>Terminal wiring method</b>		Recommended wire Solid wire: 2.5 mm <sup>2</sup> Twisted wires: AWG16, AWG18 <b>Note:</b> 1. Ferrules with insulating sleeves must be used with twisted wires. 2. Two wires can be twisted together. Recommended ferrules Al 1,5-8BK (for AWG16) manufactured by Phoenix Contact Al 1-8RD (for AWG18) manufactured by Phoenix Contact Al 0,75-8GY (for AWG18) manufactured by Phoenix Contact
<b>Case color</b>		N1.5
<b>Case material</b>		PC and ABS
<b>Weight</b>		Approx. 150 g
<b>Mounting</b>		Mounts to DIN Track.
<b>Dimensions</b>		22.5 × 90 × 100 mm (W×H×D)

K8AK-AW

Specifications

<b>Allowable operating voltage range</b>		85% to 110% of power supply voltage
<b>Allowable operating frequency range</b>		50/60 Hz $\pm 5$ Hz
<b>Input frequency range</b>		K8AK-AW1 and K8AK-AW2: DC input or AC input (45 to 65 Hz) K8AK-AW3: AC input (45 to 65 Hz)
<b>Overload capacity</b>		K8AK-AW1 and K8AK-AW2: Continuous input at 120% of maximum input, 1 s at 150% K8AK-AW3: Continuous input at 120%, 30 s at 200%, and 1 s at 600% with an OMRON CT (K8AC-CT200L). <b>Note:</b> CT capacity on primary side.
<b>Repeat accuracy</b>	<b>Operating value</b>	$\pm 0.5\%$ full scale (at 25°C and 65% humidity, rated power supply voltage, DC or 50/60 Hz sine wave input)
	<b>Operating time</b>	$\pm 50$ ms (at 25°C and 65% humidity, rated power supply voltage)
<b>Applicable standards</b>	<b>Conforming standards</b>	EN60947-5-1 Installation environment (pollution level 2, installation category III)
	<b>EMC</b>	EN60947-5-1
	<b>Safety standards</b>	UL 508 (Recognition), Korean Radio Waves Act (Act 10564), CSA: CAN/CSA C22.2 No.14, CCC: GB14048.5
<b>Insulation resistance</b>		20 M $\Omega$ min. Between external terminals and case Between power supply terminals and input terminals Between power supply terminals and output terminals Between input terminals and output terminals
<b>Dielectric strength</b>		2,000 VAC for one minute Between external terminals and case Between power supply terminals and input terminals Between power supply terminals and output terminals Between input terminals and output terminals
<b>Noise immunity</b>		1,500 V power supply terminal common/normal mode Square-wave noise of $\pm 1$ $\mu$ s/100 ns pulse width with 1-ns rise time
<b>Vibration resistance</b>		Frequency: 10 to 55 Hz, acceleration 50 m/s <sup>2</sup> 10 sweeps of 5 min each in X, Y, and Z directions
<b>Shock resistance</b>		150 m/s <sup>2</sup> , 3 times each in 6 directions along 3 axes Or 100 m/s <sup>2</sup> for relay contacts.
<b>Degree of protection</b>		Terminals: IP20

● Relationship of Mounting Distance between K8AK-AW Relays and Input Current (Reference Values)

The following diagram shows the relationship between the mounting distances and the input current. If the relay is used with an input current that exceeds these values, the temperature of the K8AK may rise and shorten the life of the internal components.

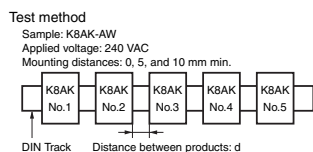
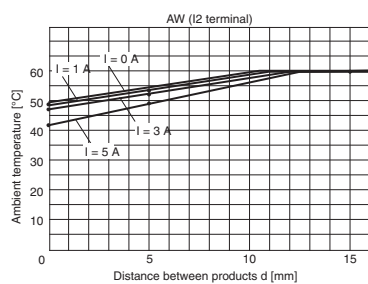

**K8AK-AW**

**Connections**

**Wiring Diagram**

**● Overcurrent and Undercurrent Operation Diagram**

DIP switch settings: SW3 ON and SW4 ON, or SW3 OFF and SW4 OFF

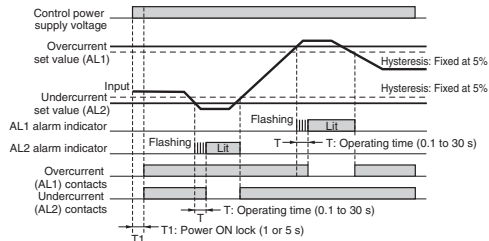

Note 1. The K8AK-AW□ output contacts are normally operative.  
 Note 2. The power ON lock prevents unnecessary alarms from being generated during the unstable period when the power is first turned ON. There is no contact output during timer operation.

**● Overcurrent and Overcurrent Operation Diagram (Overcurrent Pre-alarm Mode)**

DIP switch settings: SW3 ON and SW4 OFF.

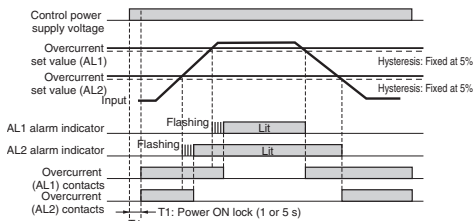

Note 1. The K8AK-AW□ output contacts are normally operative.  
 Note 2. The power ON lock prevents unnecessary alarms from being generated during the unstable period when the power is first turned ON. There is no contact output during timer operation.

**● Undercurrent and Undercurrent Operation Diagram (Undercurrent Pre-alarm Mode)**

DIP switch settings: SW3 OFF and SW4 ON.

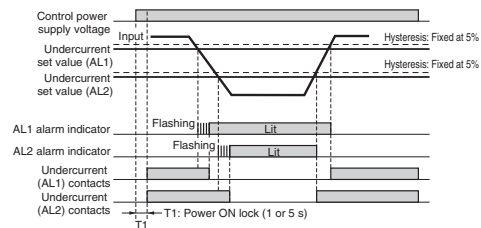

Note 1. The K8AK-AW□ output contacts are normally operative.  
 Note 2. The power ON lock prevents unnecessary alarms from being generated during the unstable period when the power is first turned ON. There is no contact output during timer operation.

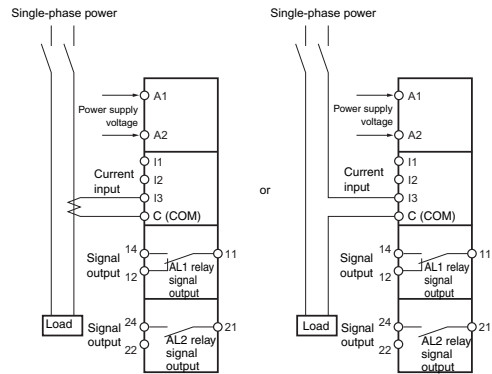

**Note 1.** The K8AK-AW3 is designed to be used in combination with the OMRON K8AC-CT200L Current Transformer (CT).  
**Note 2.** There is no polarity when a DC current input is used.  
**Note 3.** Refer to the *Setting Ranges and Wiring Connections* as the explanation of current input I1, I2, and I3 terminal.

K8AK-AW

Nomenclature

Front

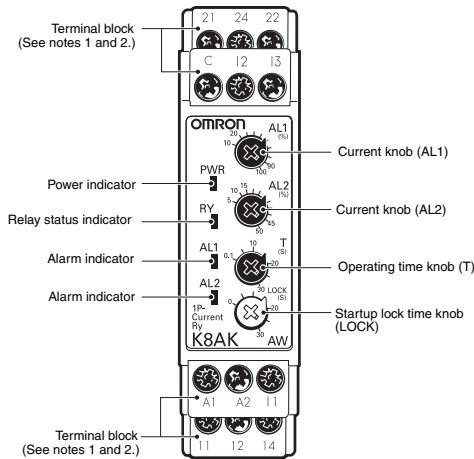

●Indicators

Item	Meaning
Power indicator (PWR: Green)	Lit when power is being supplied.
Relay status indicator (RY: Yellow)	Lit when relay is operating.
Alarm indicator (ALM: Red)	Lit when there is an overcurrent or undercurrent. The indicator flashes to indicate the error status after the input has exceeded the set value while the operating time is being clocked.

●Setting Knobs

Item	Usage
Current knob (AL1)	Used to set the current to 10% to 100% of maximum setting range.
Current knob (AL2)	Used to set the rest value to 5% to 50% of the operating value.
Operating time knob (T)	Used to set the operating time to 0.1 to 30 s.
Startup lock time knob (LOCK)	Used to set the startup lock time to 0 to 30 s.

**Note: 1.** Use either a solid wire of 2.5 mm<sup>2</sup> maximum or a ferrule with insulating sleeve for the terminal connection. The length of the exposed current-carrying part inserted into the terminal must be 8 mm or less to maintain dielectric strength after connection.

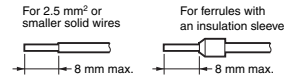

Recommended ferrules

Phoenix Contact

- Al 1,5-8BK (for AWG16)
- Al 1-8RD (for AWG18)
- Al 0,75-8GY (for AWG18)

2. Tightening torque: 0.49 N·m

**K8AK-AW**

**Operation and Setting Methods**

**●Setting Ranges and Wiring Connections**

Model	Setting range	Input type	Wiring connections
K8AK-AW1	2 to 20 mA AC/DC	Direct input	I1-COM
	10 to 100 mA AC/DC	Direct input	I2-COM
	50 to 500 mA AC/DC	Direct input	I3-COM
K8AK-AW2	0.1 to 1 A AC/DC	Direct input or commercially available CT	I1-COM
	0.5 to 5 A AC/DC		I2-COM
K8AK-AW3	10 to 100 A AC*	OMRON CT	I2-COM
	20 to 200 A AC*	OMRON CT	I3-COM

**Note:** The DC input terminals have no polarity.  
 \* The K8AK-AW3 is designed to be used in combination with the OMRON K8AC-CT200L Current Transformer (CT). (Direct input is not possible.)

**●Connections**

- Input**  
 Connect the input between the I1-COM, I2-COM, or I3-COM terminals, according to the input current. Malfunctions may occur if the input is connected to unused terminals and the Unit will not operate correctly.  
 Terminal I1 is not used by the K8AK-AW3.  
 If using the OMRON K8AC-CT200L CT, connect to terminals k and l on the K8AC-CT200L. (Terminals kt and lt are not used.)
- Power Supply**  
 Connect the power supply to terminals A1 and A2.
- Outputs**  
 AL1 (SPDT relay) is output to terminals 11, 12, and 14.  
 AL2 (SPDT relay) is output to terminals 21, 22, and 24.  
**Note:** Use the recommended ferrules if using twisted wires.

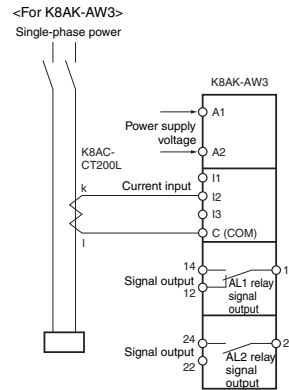

**●DIP Switch Settings**

The resetting method, relay drive method, and operating mode are set using the DIP switch located on the bottom of the Unit. K8AK-AW□ does not use SW1.

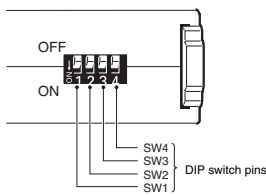

**DIP Switch Functions**

Pin	OFF ● ↑			
	OFF 1	2	3	4
Resetting method	Manual reset	●	---	---
	Automatic reset	○	---	---
Operating mode	AL1	Not used.	---	●
	Overcurrent		---	○
	Undercurrent		---	●
	Overcurrent		---	○

**Note:** All pins are set to OFF at the factory.

**●Setting Method**

- Setting Current**  
 The current knob (SV) is used to set the current.  
 The current can be set to 10% to 100% of the maximum setting range.  
 Turn the knob while there is an input to the input terminals until the alarm indicator flashes (when the set value and the input have reached the same level.)  
 Use this as a guide to set the current.  
 The maximum setting range will differ depending on the model and the input terminal.  
 Example: K8AK-AW3 Using Input Terminals I3-COM  
 The maximum measuring current will be 200 A AC and the setting range will be 20 to 200 A.

**K8AK-AW**

**2. Operating Time**

The operating time is set using the operating time knob (T).

The operating time can be set to between 0.1 and 30 s.

Turn the knob while there is an input to the input terminals until the alarm indicator flashes (when the set value and the input have reached the same level.)

Use this as a guide to set the operating time.

If the input current exceeds (drops lower than) the set value, the alarm indicator will start flashing for the set period and then stay lit.

**3. Startup Lock Time**

The startup lock time is set using the startup lock time knob (LOCK).

The startup lock time can be set to between 0 and 30 s.

Turn the knob while there is an input to the input terminals until the alarm indicator flashes (when the set value and the input have reached the same level.)

Use this as a guide to set the startup lock time.

The startup lock time will start when the input current reaches 30% or more of the set value.

Use startup lock time to prevent unwanted operation, e.g., as a result of inrush current.

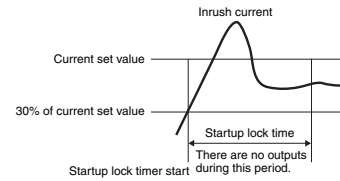

**Dimensions (Unit: mm)**

● **Single-phase Current Relays**

- K8AK-AW1
- K8AK-AW2
- K8AK-AW3

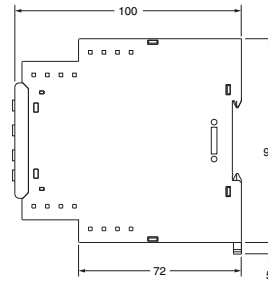
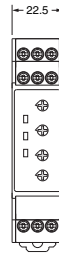

● **OMRON CT**

- K8AC-CT200L

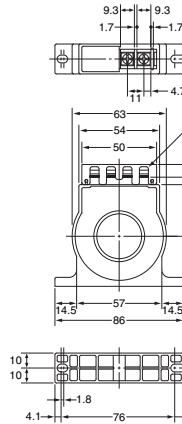

**Mounting Hole Dimensions**

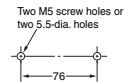

**Note:** The OMRON Current Transformer (CT) is designed to be used with the K8AK-AW3. Use terminals k and I for connections. (Terminals kt and It are not used.)

**Optional Parts for DIN Track Mounting**

● **DIN Tracks**

- PFP-100N
- PFP-50N

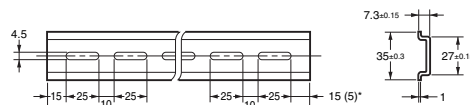
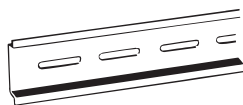

\*Dimensions in parentheses are for the PFP-50N.

K8AK-AW

Questions and Answers

**Q** Checking Operation

**A** Overcurrents  
Gradually increase the input from 80% of the set value. The input will equal the operating value when the input exceeds the set value and the alarm indicator starts flashing. Operation can be checked by the relay outputs that will start after the operating time has passed.  
Undercurrent  
Gradually decrease the input from 120% of the set value and check the operation using the same method as for overcurrent.

Example: Overcurrent Operating Mode, Normally Closed Relay Drive, and an Operating Time of 5 s.

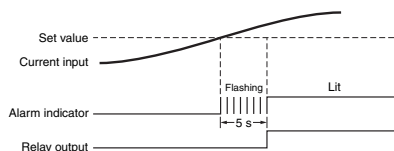

Connection Diagram

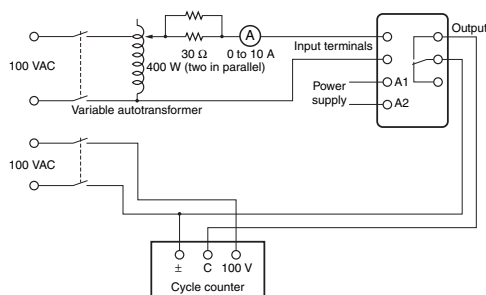

**Q** How to Measure the Operating Time

**A** Overcurrent  
Change the input suddenly from 0% to 120% of the set value and measure the time until the Unit operates.  
Undercurrent  
Change the input suddenly from 120% to 0% of the set value and measure the time until the Unit operates.

**Q** Monitoring Switch-mode Power Supplies

**A** Switch-mode Power Supplies cannot be monitored. In circuits with a capacitor input, including switch-mode power supplies, the input capacitor recharge current flows in pulse form as the load current. The K8AK-AW□ has a built-in filter as a countermeasure against high frequencies and cannot be used to remove pulse current.

**Q** Can a motor with a rated current of 5 A be monitored using the K8AK? Are there any application precautions?

**A** The K8AK-AW1 and K8AK-AW2 cannot be used with motor loads. Use the K8AK-AW3 in combination with the K8AC-CT200L Current Transformer (CT). With motor loads, the startup current and stall current will cause a current of many times the rated current to flow. Refer to the following figure for information on the motor startup current.

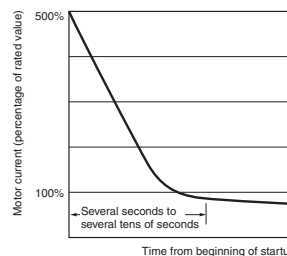

For a motor with a rating of 5 A, the startup current will be approximately 30 A. The startup current will exceed the overload capacity (rating: 150% for 1 s) of the K8AK-AW1 and K8AK-AW2 and result in failure of the Relay. To monitor the motor load, use the K8AK-AW3. (Overload capacity: 120% of rating for continuous load, 200% of rating for 30 s, and 600% of rating for 1 s). The K8AK-AW3 has a large input range. Pass the conductors multiple times through the special CT.

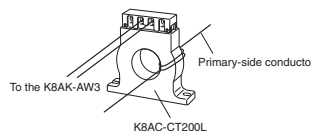

Concept behind Passing Conductor through the CT When Using the K8AK-AW3

Example: Monitoring Overload of a Motor with a Rated Current of 5 A  
K8AK set value:  
Overcurrent detection, operating value setting: 25%, operating time: 0.1 s  
Startup lock timer: 0.1 to 30 s (Set the timer according to the duration of the startup current.)

The setting range for the K8AK-AW3 is 10% to 100% of the rated current (i.e., 10 to 100 A). Pass the conductors through the CT five times so that at least 10 A of current flows. The input current to the K8AK will be 25 A (i.e., 5 A x 5 loops).  
If a startup current of six times the rated current is generated, it will be 150 A (i.e., 25 A x 6). The overload capacity for the K8AK-AW3 is 200% of the rating for 30 s. The Relay will not fail even if the startup current continues for 30 s, and it is possible to perform overload detection.

## Single-phase Voltage Relay K8AK-VS

### Ideal for voltage monitoring for industrial facilities and equipment.

- Monitor for overvoltages or undervoltages.
- Manual resetting and automatically resetting supported by one Relay.
- One SPDT output relay, 5 A at 250 VAC (resistive load).
- Output relay can be switched between normally open and normally closed.
- Process control signal (0 to 10 V) and current splitter input supported.
- Output status can be monitored using LED indicator.
- Input frequency of 40 to 500 Hz supported.
- Inputs are isolated from the power supply.
- RoHS-compliant.



For the most recent information on models that have been certified for safety standards, refer to your OMRON website.

Refer to *Safety Precautions for the K8AK Series* on page 86. Refer to page 30 for commonly asked questions.

### Ordering Information

#### List of Models

Setting range	Control power supply voltage	Model
1 to 10 V AC/DC 3 to 30 V AC/DC 15 to 150 V AC/DC	24 VAC/DC 100 to 240 VAC	<b>K8AK-VS2 24 VAC/DC</b> <b>K8AK-VS2 100-240 VAC</b>
20 to 200 V AC/DC 30 to 300 V AC/DC 60 to 600 V AC/DC	24 VAC/DC 100 to 240 VAC	<b>K8AK-VS3 24 VAC/DC</b> <b>K8AK-VS3 100-240 VAC</b>

### Ratings and Specifications

#### Input Range

Model	Range*	Connection terminal	Setting range	Input impedance	Overload capacity
K8AK-VS2	0 to 10 V AC/DC	V1-COM	1 to 10 V AC/DC, 3 to 30 V AC/DC, 15 to 150 V AC/DC	Approx. 120 kΩ	Continuous input at 115% of maximum input 10 s at 125% (up to 600 VAC)
	0 to 30 V AC/DC	V2-COM		Approx. 320 kΩ	
	0 to 150 V AC/DC	V3-COM		Approx. 1.6 MΩ	
K8AK-VS3	0 to 200 V AC/DC	V1-COM	20 to 200 V AC/DC, 30 to 300 V AC/DC, 60 to 600 V AC/DC	Approx. 1.2 MΩ	
	0 to 300 V AC/DC	V2-COM		Approx. 1.7 MΩ	
	0 to 600 V AC/DC	V3-COM		Approx. 3.1 MΩ	

\* The range is selected using connected terminals.



### K8AK-VS

#### Ratings

Power supply voltage	Isolated power supply	24 VAC/DC 100 to 240 VAC
Power consumption		24 VAC/DC: 2.0 VA/1.1 W max. 100 to 240 VAC: 4.6 VA max.
Operating value setting range (SV)		10% to 100% of maximum setting range K8AK-VS2: 1 to 10 V AC/DC 3 to 30 V AC/DC 15 to 150 V AC/DC K8AK-VS3: 20 to 200 V AC/DC 30 to 300 V AC/DC 60 to 600 V AC/DC
Operating value		100% operation at set value
Reset value setting range (HYS.)		5% to 50% of operating value
Reset method		Manual reset/automatic reset (switchable) <b>Note:</b> Manual reset: Turn OFF power supply for 1 s or longer.
Operating time setting range (T)		0.1 to 30 s
Power ON lock time (LOCK)		1 s or 5 s (Switched using DIP switch.)
Indicators		Power (PWR): Green, Relay output (RY): Yellow, Alarm outputs (ALM): Red
Input impedance		Refer to <i>Input Range</i> on previous page.
Output relays		One SPDT relay (NO/NC switched using DIP switch.)
Output relay ratings		Rated load Resistive load 5 A at 250 VAC 5 A at 30 VDC Maximum contact voltage: 250 VAC or 30 VDC Max. switching current: 5 A Maximum switching capacity: 1,250 VA, 150 W Mechanical life: 10 million operations min. Electrical life: 5 A at 250 VAC or 30 VDC: 50,000 operations 3 A at 250 VAC or 30 VDC: 100,000 operations
Ambient operating temperature		-20 to 60°C (with no condensation or icing)
Storage temperature		-25 to 65°C (with no condensation or icing)
Ambient operating humidity		25% to 85% (with no condensation)
Storage humidity		25% to 85% (with no condensation)
Altitude		2,000 m max.
Terminal screw tightening torque		0.49 N·m
Terminal wiring method		Recommended wire Solid wire: 2.5 mm <sup>2</sup> Twisted wires: AWG16, AWG18 <b>Note:</b> 1. Ferrules with insulating sleeves must be used with twisted wires. 2. Two wires can be twisted together. Recommended ferrules Al 1,5-8BK (for AWG16) manufactured by Phoenix Contact Al 1-8RD (for AWG18) manufactured by Phoenix Contact Al 0,75-8GY (for AWG18) manufactured by Phoenix Contact
Case color		N1.5
Case material		PC and ABS
Weight		Approx. 150 g
Mounting		Mounts to DIN Track.
Dimensions		22.5 × 90 × 100 mm (W×H×D)

K8AK-VS

**Specifications**

<b>Allowable operating voltage range</b>		85% to 110% of rated power supply voltage
<b>Allowable operating frequency range</b>		50/60 Hz ±5 Hz
<b>Input frequency</b>		40 to 500 Hz
<b>Overload capacity</b>		Continuous input at 115% of maximum input, 10 s at 125% (up to 600 VAC).
<b>Repeat accuracy</b>	<b>Operating value</b>	±0.5% full scale (at 25°C and 65% humidity, rated power supply voltage, DC or 50/60 Hz sine wave input)
	<b>Operating time</b>	±50 ms (at 25°C and 65% humidity, rated power supply voltage)
<b>Applicable standards</b>	<b>Conforming standards</b>	EN60947-5-1 Installation environment (pollution level 2, installation category III)
	<b>EMC</b>	EN60947-5-1
	<b>Safety standards</b>	UL 508 (Recognition), Korean Radio Waves Act (Act 10564), CSA: CAN/CSA C22.2 No.14, CCC: GB14048.5
<b>Insulation resistance</b>		20 MΩ min. Between external terminals and case Between power supply terminals and input terminals Between power supply terminals and output terminals Between input terminals and output terminals
<b>Dielectric strength</b>		2,000 VAC for one minute Between external terminals and case Between power supply terminals and input terminals Between power supply terminals and output terminals Between input terminals and output terminals
<b>Noise immunity</b>		1,500 V power supply terminal common/normal mode Square-wave noise of ±1 μs/100 ns pulse width with 1-ns rise time
<b>Vibration resistance</b>		Frequency: 10 to 55 Hz, acceleration 50 m/s <sup>2</sup> 10 sweeps of 5 min each in X,Y, and Z directions
<b>Shock resistance</b>		150 m/s <sup>2</sup> 3 times each in 6 directions along 3 axes. Or 100 m/s <sup>2</sup> for relay contacts.
<b>Degree of protection</b>		Terminals: IP20

**K8AK-VS**

**Connections**

**Wiring Diagram**

**●Overvoltage Operation Diagram (Output Relay Drive Method: Normally Closed)**

DIP switch setting: SW3 ON.

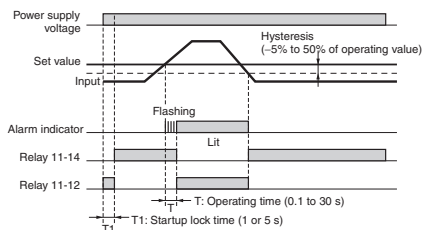

**Note:** The power ON lock prevents unnecessary alarms from being generated during the instable period when the power is first turned on. There is no relay output during timer operation.

**●Undervoltage Operation Diagram (Output Relay Drive Method: Normally Open)**

DIP switch setting: SW3 OFF.

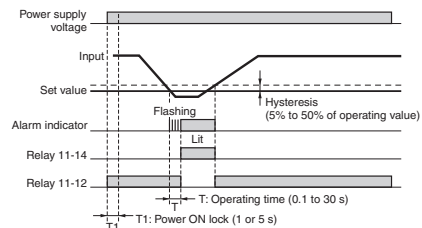

**Note:** The power ON lock prevents unnecessary alarms from being generated during the instable period when the power is first turned on. There is no relay output during timer operation.

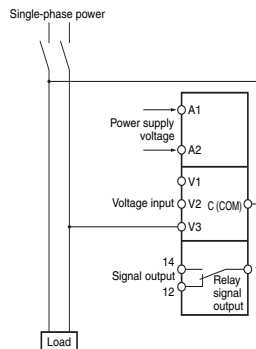

**Note:** There is no polarity when a DC current input is used.

K8AK-VS

Nomenclature

Front

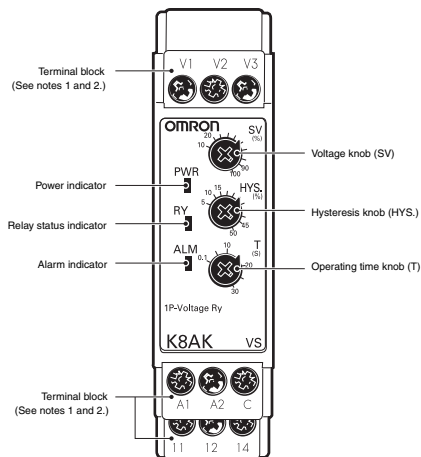

●Indicators

Item	Meaning
Power indicator (PWR: Green)	Lit when power is being supplied.
Relay status indicator (RY: Yellow)	Lit when relay is operating
Alarm indicator (ALM: Red)	Lit when there is an overvoltage or undervoltage. The indicator flashes to indicate the error status after the input has exceeded the set value while the operating time is being clocked.

●Setting Knobs

Item	Usage
Voltage knob (SV)	Used to set the voltage to 10% to 100% of maximum setting range.
Hysteresis knob (HYS.)	Used to set the rest value to 5% to 50% of the operating value.
Operating time knob (T)	Used to set the operating time to 0.1 to 30 s.

**Note: 1.** Use either a solid wire of 2.5 mm<sup>2</sup> maximum or a ferrule with insulating sleeve for the terminal connection. The length of the exposed current-carrying part inserted into the terminal must be 8 mm or less to maintain dielectric strength after connection.

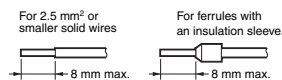

Recommended ferrules  
Phoenix Contact

- Al 1,5-8BK (for AWG16)
- Al 1-8RD (for AWG18)
- Al 0,75-8GY (for AWG18)

2. Tightening torque: 0.49 N·m

## K8AK-VS

### Operation and Setting Methods

#### ●Setting Ranges and Wiring Connections

Model	Setting range	Wiring connection
K8AK-VS2	1 to 10 V AC/DC	V1-COM
	3 to 30 V AC/DC	V2-COM
	15 to 150 V AC/DC	V3-COM
K8AK-VS3	20 to 200 V AC/DC	V1-COM
	30 to 300 V AC/DC	V2-COM
	60 to 600 V AC/DC	V3-COM

#### ●Connections

- Input**  
Connect the input between terminals V1-COM, V2-COM, or V3-COM, depending on the input voltage.  
Malfunctions may occur if the input is connected to unused terminals and the Unit will not operate correctly.
  - Power Supply**  
Connect the power supply to terminals A1 and A2.
  - Outputs**  
SPDT relays are output to terminals 11, 12, and 14.
- Note:** Use the recommended ferrules if using twisted wires.

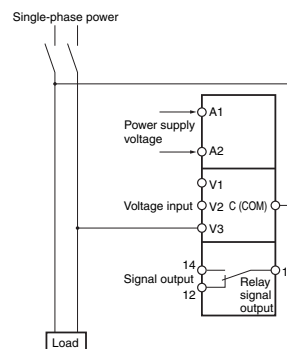

#### ●DIP Switch Settings

The power ON lock time, resetting method, relay drive method, and operating mode are set using the DIP switch located on the bottom of the Unit.

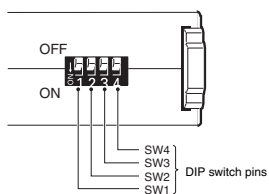

#### DIP Switch Functions

Pin	OFF ● ↑	OFF 1	2	3	4
	ON ○ ↓	ON			
Power ON lock time	1 s	●	---	---	---
	5 s	○	---	---	---
Resetting method	Manual reset	---	●	---	---
	Automatic reset	---	○	---	---
Relay drive method	Normally open	---	---	●	---
	Normally closed	---	---	○	---
Operating mode	Oversvoltage	---	---	---	●
	Undersvoltage	---	---	---	○

**Note:** All pins are set to OFF at the factory.

## K8AK-VS

### ●Setting Method

#### 1. Setting Voltage

The voltage knob (SV) is used to set the voltage.  
 The voltage can be set to 10% to 100% of the maximum setting range.  
 Turn the knob while there is an input to the input terminals until the alarm indicator flashes (when the set value and the input have reached the same level.)  
 Use this as a guide to set the voltage.  
 The maximum setting range will differ depending on the model and the input terminal.  
 Example: K8AK-VS3 Using Input Terminal V3-COM  
 The maximum setting range will be 600 VAC/VDC and the setting range will be 60 to 600 V.

#### 2. Hysteresis

Hysteresis is set using the hysteresis knob (HYS.)  
 The setting range is 5 to 50% of the operating value.  
 Turn the knob while there is an input to the input terminals until the alarm indicator flashes (when the set value and the input have reached the same level.)  
 Use this as a guide to set the hysteresis.  
 Example: Maximum Setting of 600 VAC/VDC, Voltage Set Value (SV) of 50%, and Overvoltage Operation  
 Operation will be at 300 V and resetting at 270 V when the hysteresis (HYS.) is set to 10%.

#### 3. Operating Time

The operating time is set using the operating time knob (T).  
 The operating time can be set to between 0.1 and 30 s.  
 Turn the knob while there is an input to the input terminals until the alarm indicator flashes (when the set value and the input have reached the same level.)  
 Use this as a guide to set the operating time.  
 If the input voltage exceeds (or drops lower than) the voltage set value, the alarm indicator will start flashing for the set period and then stay lit.

### Dimensions

(Unit: mm)

#### Single-phase Voltage Relays

K8AK-VS2  
 K8AK-VS3

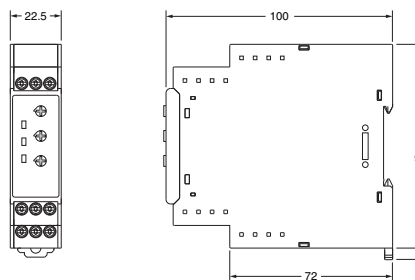

#### Optional Parts for DIN Track Mounting

●DIN Tracks  
 PFP-100N  
 PFP-50N

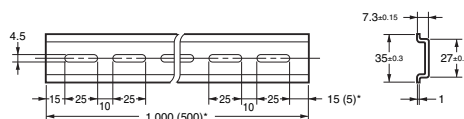
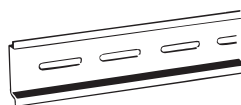

\*Dimensions in parentheses are for the PFP-50N.

K8AK-VS

Questions and Answers

**Q** Checking Operation

**A** Overvoltages  
 Gradually increase the input from 80% of the set value. The input will equal the operating value when the input exceeds the set value and the alarm indicator starts flashing. Operation can be checked by the relay outputs that will start after the operating time has passed.  
 Undervoltages  
 Gradually decrease the input from 120% of the set value and check the operation using the same method as for overvoltage.

Example: Overvoltage Operating Mode and an Operating Time of 5 s  
 Note: K8AK-VS□ output relays are normally operative.

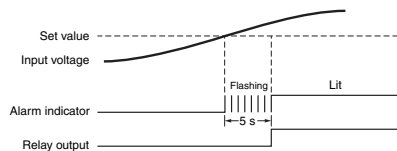

Connection Diagram

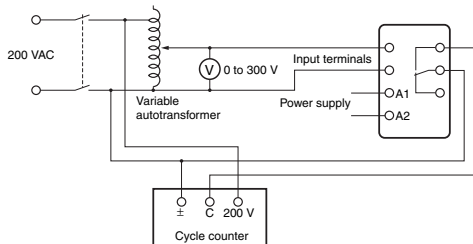

**Q** How to Measure the Operating Time

**A** Overvoltage  
 Change the input suddenly from 0% to 120% of the set value and measure the time until the Unit operates.  
 Undervoltage  
 Change the input suddenly from 120% to 0% of the set value and measure the time until the Unit operates.

## Single-phase Overvoltage/Undervoltage Relays K8AK-VW

### Ideal for voltage monitoring for industrial facilities and equipment.

- Monitor for overvoltages and undervoltages simultaneously. Separate settings and outputs supported for overvoltages and undervoltages.
- Manual resetting and automatically resetting supported by one Relay.
- Pre-alarm Monitoring Mode.
- Two SPDT output relays, 5 A at 250 VAC (resistive load).
- Process control signal (0 to 10 V) and current splitter input supported.
- Output status can be monitored using LED indicator.
- Input frequency of 40 to 500 Hz supported.
- Inputs are isolated from the power supply.
- RoHS-compliant.



For the most recent information on models that have been certified for safety standards, refer to your OMRON website.

Refer to *Safety Precautions for the K8AK Series* on page 86. Refer to page 38 for commonly asked questions.

### Ordering Information

#### List of Models

Setting range	Supply voltage	Model
1 to 10 V AC/DC 3 to 30 V AC/DC 15 to 150 V AC/DC	24 VAC/DC 100 to 240 VAC	<b>K8AK-VW2 24 VAC/DC</b> <b>K8AK-VW2 100 to 240 VAC</b>
20 to 200 V AC/DC 30 to 300 V AC/DC 60 to 600 V AC/DC	24 VAC/DC 100 to 240 VAC	<b>K8AK-VW3 24 VAC/DC</b> <b>K8AK-VW3 100 to 240 VAC</b>

### Ratings and Specifications

#### Input Range

Model	Range *	Connection terminal	Setting range	Input impedance	Overload capacity
K8AK-VW2	0 to 10 V AC/DC	V1-COM	1 to 10 V AC/DC	Approx. 120 kΩ	Continuous input at 115% of maximum input. 10 s at 125% (up to 600 VAC)
	0 to 30 V AC/DC	V2-COM	3 to 30 V AC/DC	Approx. 320 kΩ	
	0 to 150 V AC/DC	V3-COM	15 to 150 V AC/DC	Approx. 1.6 MΩ	
K8AK-VW3	0 to 200 V AC/DC	V1-COM	20 to 200 V AC/DC	Approx. 1.2 MΩ	
	0 to 300 V AC/DC	V2-COM	30 to 300 V AC/DC	Approx. 1.7 MΩ	
	0 to 600 V AC/DC	V3-COM	60 to 600 V AC/DC	Approx. 3.1 MΩ	

\* The range is selected using connected terminals.



### K8AK-VW

#### Ratings

Power supply voltage	Isolated power supply	24 VAC/DC 100 to 240 VAC
Power consumption		24 VAC/DC: 2.0 VA/1.1 W max. 100 to 240 VAC: 4.6 VA max.
Operating value setting range (AL1 and AL2)		10% to 100% of the maximum value of the setting range K8AK-VW2: 1 to 10 V AC/DC 3 to 30 V AC/DC 15 to 150 V AC/DC K8AK-VW3: 20 to 200 V AC/DC 30 to 300 V AC/DC 60 to 600 V AC/DC
Operating value		100% operation at set value
Reset value		5% of operating value (fixed)
Reset method		Manual reset/automatic reset (switchable) <b>Note:</b> Manual reset: Turn OFF power supply for 1 s or longer.
Operating time setting range (T)		0.1 to 30 s
Power ON lock time (LOCK)		1 s or 5 s (Switched using DIP switch.)
Indicators		Power (PWR): Green, Relay output (RY): Yellow, Alarm outputs (AL1, AL2): Red
Input impedance		Refer to <i>Input Range</i> on previous page.
Output relays		Two SPDT relays (NC operation)
Output relay ratings		Rated load Resistive load 5 A at 250 VAC 5 A at 30 VDC Maximum contact voltage: 250 VAC or 30 VDC Max. switching current: 5 A Maximum switching capacity: 1,250 VA, 150 W Mechanical life: 10 million operations min. Electrical life: 5 A at 250 VAC or 30 VDC: 50,000 operations 3 A at 250 VAC or 30 VDC: 100,000 operations
Ambient operating temperature		-20 to 60°C (with no condensation or icing)
Storage temperature		-25 to 65°C (with no condensation or icing)
Ambient operating humidity		25% to 85% (with no condensation)
Storage humidity		25% to 85% (with no condensation)
Altitude		2,000 m max.
Terminal screw tightening torque		0.49 N·m
Terminal wiring method		Recommended wire Solid wire: 2.5 mm <sup>2</sup> Twisted wires: AWG16, AWG18 <b>Note:</b> 1. Ferrules with insulating sleeves must be used with twisted wires. 2. Two wires can be twisted together. Recommended ferrules Al 1,5-8BK (for AWG16) manufactured by Phoenix Contact Al 1-8RD (for AWG18) manufactured by Phoenix Contact Al 0,75-8GY (for AWG18) manufactured by Phoenix Contact
Case color		N1.5
Case material		PC and ABS
Weight		Approx. 150 g
Mounting		Mounts to DIN Track.
Dimensions		22.5 × 90 × 100 mm (W×H×D)

K8AK-VW

**Specifications**

<b>Allowable operating voltage range</b>		85% to 110% of rated power supply voltage
<b>Allowable operating frequency range</b>		50/60 Hz $\pm$ 5 Hz
<b>Input frequency range</b>		40 to 500 Hz
<b>Overload capacity</b>		Continuous input at 115% of maximum input, 10 s at 125% (up to 600 VAC).
<b>Repeat error</b>	<b>Operating value</b>	$\pm$ 0.5% full scale (at 25°C and an ambient humidity of 65% at the rated power supply voltage, DC and 50/60 Hz sine wave input)
	<b>Operating time</b>	$\pm$ 50 ms (at 25°C and 65% humidity, rated power supply voltage)
<b>Applicable standards</b>	<b>Conforming standards</b>	EN60947-5-1 Installation environment (pollution level 2, installation category III)
	<b>EMC</b>	EN60947-5-1
	<b>Safety standards</b>	UL 508 (Recognition), Korean Radio Waves Act (Act 10564), CSA: CAN/CSA C22.2 No.14, CCC: GB14048.5
<b>Insulation resistance</b>		20 M $\Omega$ min. Between all external terminals and the case Between all power supply terminals and all input terminals Between all power supply terminals and all output terminals Between all input terminals and all output terminals
<b>Dielectric strength</b>		2,000 VAC for 1 min Between all external terminals and the case Between all power supply terminals and all input terminals Between all power supply terminals and all output terminals Between all input terminals and all output terminals
<b>Noise immunity</b>		1,500 V power supply terminal common/normal mode Square-wave noise of $\pm$ 1 $\mu$ s/100 ns pulse width with 1-ns rise time
<b>Vibration resistance</b>		Frequency: 10 to 55 Hz, acceleration 50 m/s <sup>2</sup> 10 sweeps of 5 min each in X, Y, and Z directions
<b>Shock resistance</b>		150 m/s <sup>2</sup> 3 times each in 6 directions along 3 axes. Or 100 m/s <sup>2</sup> for relay contacts.
<b>Degree of protection</b>		Terminals: IP20

**K8AK-VW**

**Connections**

**Wiring Diagram**

**●Overvoltage and Undervoltage Operation Diagram**

DIP switch settings: SW3 and SW4 both ON or both OFF.

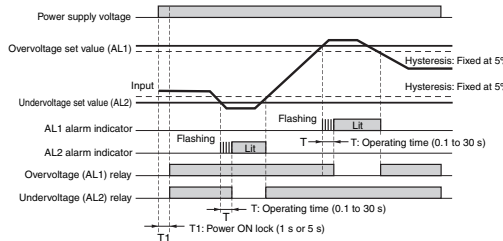

- Note:**
1. The K8AK-VW□ output relay is normally operative.
  2. The power ON lock prevents unnecessary alarms from being generated during the instable period when the power is first turned on. There is no relay output during timer operation.

**●Overvoltage and Overvoltage Operation Diagram (Overvoltage Pre-alarm Mode)**

DIP switch settings: SW3 ON and SW4 OFF.

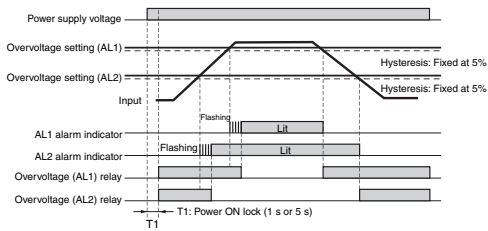

- Note:**
1. The K8AK-VW□ output relay is normally operative.
  2. The power ON lock prevents unnecessary alarms from being generated during the instable period when the power is first turned on. There is no relay output during timer operation.

**●Undervoltage and Undervoltage Operation Diagram (Undervoltage Pre-alarm Mode)**

DIP switch settings: SW3 OFF and SW4 ON.

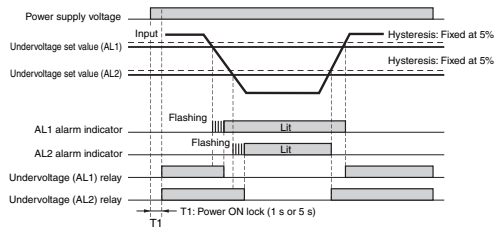

- Note:**
1. The K8AK-VW□ output relay is normally operative.
  2. The power ON lock prevents unnecessary alarms from being generated during the instable period when the power is first turned on. There is no relay output during timer operation.

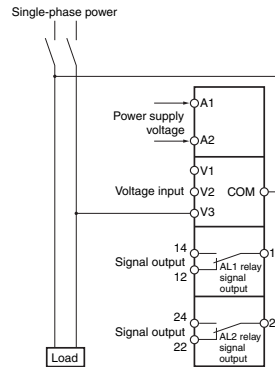

**Note:** There is no polarity when a DC current input is used.

### K8AK-VW

### Nomenclature

#### Front

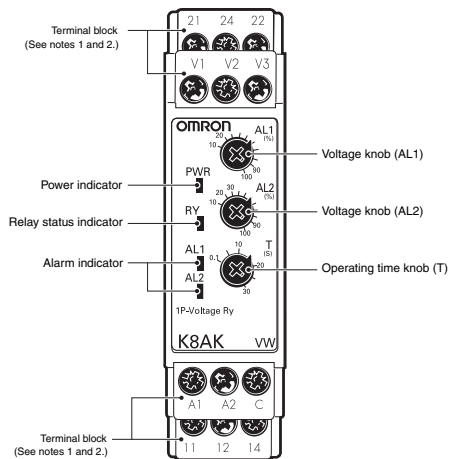

#### ●Indicators

Item	Meaning
Power indicator (PWR: Green)	Lit when power is being supplied.
Relay status indicator (RY: Yellow)	Lit when relay operates (Not light when both AL1 and AL2 are in error status) (Normally lit)
Alarm indicators (AL1 and AL2: Red)	Lit when there is an overvoltage or undervoltage. The indicator flashes to indicate the error status after the input has exceeded the set value while the operating time is being clocked.

#### ●Setting Knobs

Item	Usage
Voltage knob (AL1)	Used to set the voltage to 10% to 100% of maximum setting range.
Voltage knob (AL2)	Used to set the voltage to 10% to 100% of maximum setting range.
Operating time knob (T)	Used to set the operating time to 0.1 to 30 s.

**Note: 1.** Use either a solid wire of 2.5 mm<sup>2</sup> maximum or a ferrule with insulating sleeve for the terminal connection. The length of the exposed current-carrying part inserted into the terminal must be 8 mm or less to maintain dielectric strength after connection.

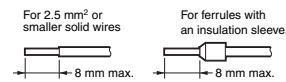

#### Recommended ferrules

##### Phoenix Contact

- Al 1,5-8BK (for AWG16)
- Al 1-8RD (for AWG18)
- Al 0,75-8GY (for AWG18)

2. Screw tightening torque: 0.49 N·m max.

**K8AK-VW**

**Operation and Setting Methods**

● **Setting Ranges and Wiring Connections**

Model	Setting range	Wiring connection
K8AK-VW2	1 to 10 V AC/DC	V1-COM
	3 to 30 V AC/DC	V2-COM
	15 to 150 V AC/DC	V3-COM
K8AK-VW3	20 to 200 V AC/DC	V1-COM
	30 to 300 V AC/DC	V2-COM
	60 to 600 V AC/DC	V3-COM

● **Connections**

- Input**  
Connect the input between terminals V1-COM, V2-COM, or V3-COM, depending on the input voltage.  
Malfunctions may occur if the input is connected to unused terminals and the Unit will not operate correctly.
  - Power Supply**  
Connect the power supply to terminals A1 and A2.
  - Outputs**  
AL1 (SPDT relay) is output to terminals 11, 12, and 14.  
AL2 (SPDT relay) is output to terminals 21, 22, and 24.
- Note:** Use the recommended ferrules if using twisted wires.

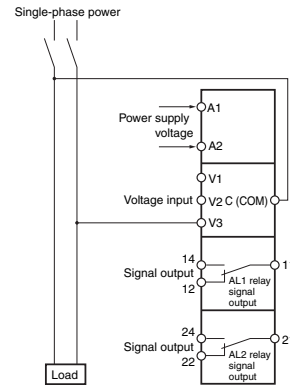

● **DIP Switch Settings**

The power ON lock time, resetting method and operating mode are set using the DIP switch located on the bottom of the Unit.

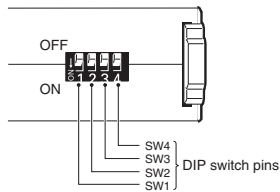

**DIP Switch Functions**

Pin	OFF ● ↑					
	OFF 1	2	3	4		
Power ON lock time	1 s	●	---	---	---	
	5 s	○	---	---	---	
Resetting method	Manual reset	---	●	---	---	
	Operating mode	---	○	---	---	
Operating mode	AL1	AL2				
	Overvoltage	Undervoltage	---	---	●	●
	Overvoltage	Overvoltage	---	---	○	●
	Undervoltage	Undervoltage	---	---	●	○
	Overvoltage	Undervoltage	---	---	○	○

**Note:** All pins are set to OFF at the factory.

● **Setting Method**

- Setting Voltage**  
The voltage knob (AL1 and AL2) is used to set the voltage.  
The voltage can be set to 10% to 100% of the maximum setting range.  
Turn the knob while there is an input to the input terminals until the alarm indicator flashes (when the set value and the input have reached the same level.)  
Use this as a guide to set the voltage.  
The maximum setting range will differ depending on the model and the input terminal.  
Example: K8AK-VW3 Using Input Terminal V3-COM  
The maximum setting range will be 600 VAC/VDC and the setting range will be 60 to 600 V.
- Operating Time**  
The operating time is set using the operating time knob (T).  
The operating time can be set to between 0.1 and 30 s.  
Turn the knob while there is an input to the input terminals until the alarm indicator flashes (when the set value and the input have reached the same level.)  
Use this as a guide to set the operating time.  
If the input exceeds (or drops lower than) the voltage set value, the alarm indicator will start flashing for the set period and then stay lit.

# Datenblatt

## Spannungsüberwachungsrelais K8DS-PM

K8DS-PM



### K8AK-VW

(Unit: mm)

#### Dimensions

##### Single-phase Voltage Relays

K8AK-VW2  
K8AK-VW3

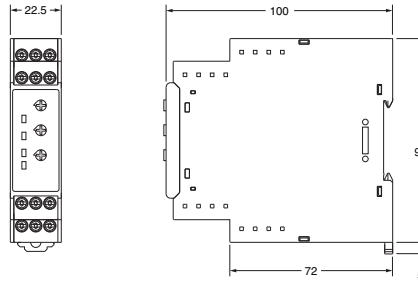

#### Optional Parts for DIN Track Mounting

##### ●DIN Tracks

PFP-100N  
PFP-50N

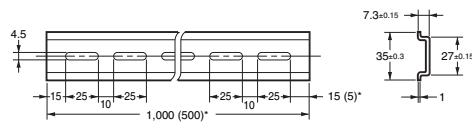
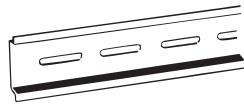

\*Dimensions in parentheses are for the PFP-50N.

K8AK-VW

Questions and Answers

**Q** Checking Operation

**A** Overvoltages  
 Gradually increase the input from 80% of the set value. The input will equal the operating value when the input exceeds the set value and the alarm indicator starts flashing. Operation can be checked by the relay outputs that will start after the operating time has passed.  
 Undervoltage  
 Gradually decrease the input from 120% of the set value and check the operation using the same method as for overvoltage.

Example: Overvoltage Operating Mode, Undervoltage Operating Mode and an Operating Time of 5 s

Note: K8AK-VW □ output relays are normally operative.

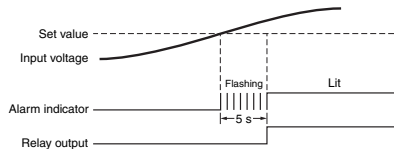

Connection Diagram

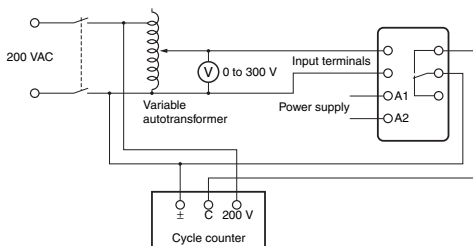

**Q** How to Measure the Operating Time

**A** Overvoltage  
 Change the input suddenly from 0% to 120% of the set value and measure the time until the Unit operates.  
 Undervoltage  
 Change the input suddenly from 120% to 0% of the set value and measure the time until the Unit operates.

**Q** Setting the Pre-alarm Monitoring Mode

**A** Use the DIP switch to set the operating mode pins both to overvoltage (SW3 ON and SW4 OFF) or both to undervoltage (SW3 OFF and SW4 ON).

Example: Both Pins Set to Overvoltage  
 AL1 can be used as the pre-alarm for AL2 by setting a smaller voltage set value for AL1 than for AL2.

## Phase-sequence Phase-loss Relay **K8DS-PH**

### Three-phase Phase-sequence Phase-loss Relay Using Voltage Detection Method

- Lineup includes a 17.5-mm slim, compact model. *NEW*
- Greater resistance to inverter noise. *NEW*
- Distinguishes between positive phases, reversed phases, and phase loss when power is turned ON.
- Supports phase loss detection when the motor is operating.
- Output status can be monitored using LED indicator.
- Ideal to prevent reverse operation of motors.
- RoHS-compliant.

Refer to *Safety Precautions for the K8AK Series* on page 86.  
Refer to page 44 for commonly asked questions.



For the most recent information on models that have been certified for safety standards, refer to your OMRON website.

### Ordering Information

#### List of Models

Function	Rated input voltage*	Relay output	Model
Phase sequence and phase loss monitoring	3-phase, 3-wire 200 to 480 VAC	SPDT × 1	<b>K8DS-PH1</b>

\* The power supply is shared with the rated input voltage.



## K8DS-PH

### Ratings and Specifications

#### Ratings

<b>Rated input voltage</b>	3-phase, 200 to 480 VAC (3-wire)
<b>Input load</b>	Approx. 2.7 VA
<b>Reversed phase and phase loss operating time</b>	0.1 s max.
<b>Reset method</b>	Automatic reset
<b>Indicators</b>	Power (PWR): Green, Relay output (RY): Yellow
<b>Output relays</b>	One SPDT relay (NC operation)
<b>Output relay ratings</b>	Rated load Resistive load 5 A at 250 VAC 5 A at 30 VDC Max. switching voltage 250 VAC or 30 VDC Max. switching current: 5 A Maximum switching capacity: 1,250 VA, 150 W Mechanical life: 10 million operations min. Electrical life: 5 A at 250 VAC or 30 VDC:50,000 operations 3 A at 250 VAC/30 VDC:100,000 operations
<b>Ambient operating temperature</b>	-20 to 60°C (with no condensation or icing)
<b>Storage temperature</b>	-25 to 65°C (with no condensation or icing)
<b>Ambient operating humidity</b>	25% to 85% (with no condensation)
<b>Storage humidity</b>	25% to 85% (with no condensation)
<b>Altitude</b>	2,000 m max.
<b>Terminal screw tightening torque</b>	0.49 N·m
<b>Terminal wiring method</b>	Recommended wire Solid wire: 2.5 mm <sup>2</sup> Twisted wires: AWG16, AWG18 <b>Note:</b> 1. Ferrules with insulating sleeves must be used with twisted wires. 2. Two wires can be twisted together. Recommended ferrules Al 1.5-8BK (for AWG16) manufactured by Phoenix Contact Al 1-8RD (for AWG18) manufactured by Phoenix Contact Al 0.75-8GY (for AWG18) manufactured by Phoenix Contact
<b>Case color</b>	N1.5
<b>Case material</b>	PC and ABS
<b>Weight</b>	Approx. 60 g
<b>Mounting</b>	Mounts to DIN Track.
<b>Dimensions</b>	17.5 × 80 × 73 mm (W×D×H)

K8DS-PH

**Specifications**

<b>Input voltage range</b>	200 to 480 VAC	
<b>Input frequency</b>	50/60 Hz (no presumed range)	
<b>Overload capacity</b>	Continuous 500 V	
<b>Applicable standards</b>	<b>Conforming standards</b>	EN60947-5-1 Installation environment (pollution level 2, installation category III)
	<b>EMC</b>	EN60947-5-1
	<b>Safety standards</b>	UL 508 (Recognition), Korean Radio Waves Act (Act 10564), CSA: CAN/CSA C22.2 No.14, CCC: GB14048.5
<b>Insulation resistance</b>	20 MΩ min. Between external terminals and case Between input terminals and output terminals	
<b>Dielectric strength</b>	2,000 VAC for one minute Between external terminals and case Between input terminals and output terminals	
<b>Noise immunity</b>	1,500 V power supply terminal common/normal mode Square-wave noise of ±1 μs/100 ns pulse width with 1-ns rise time	
<b>Vibration resistance</b>	Frequency: 10 to 55 Hz, acceleration 50 m/s <sup>2</sup> 10 sweeps of 5 min each in X, Y, and Z directions	
<b>Shock resistance</b>	150 m/s <sup>2</sup> , 3 times each in 6 directions along 3 axes However, 100 m/s <sup>2</sup> for relay contacts.	
<b>Degree of protection</b>	Terminals: IP20	

**●Relationship of Mounting Distance between K8DS-PH Relays and Ambient Temperature (Reference Values)**

The following diagram shows the relationship between the mounting distances and the ambient temperature.

If the relay is used with an ambient temperature that exceeds these values, the temperature of the K8DS may rise and shorten the life of the internal components.

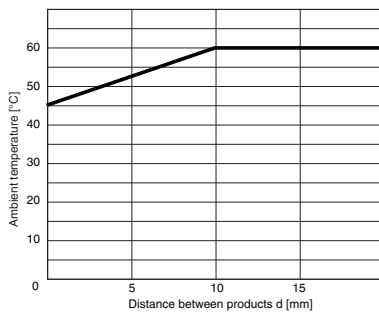

**Test method**

Sample: K8DS-PH

Mounting distances: 0, 5, and 10 mm min.

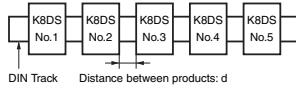

**K8DS-PH**

**Connections**

**Wiring Diagram**

**●Phase Sequence and Phase Loss Operation Diagram**

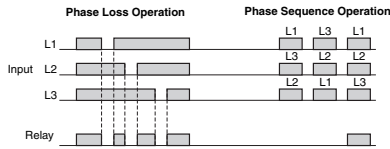

- Note:**
1. The K8DS-PH1 output contacts are normally operative.
  2. The Relay will not operate if the input voltage drops below 70% of the minimum input value because L1 and L2 are also used to provide power.
  3. Phase loss cannot be detected on the load side because this detection is based on the voltage.

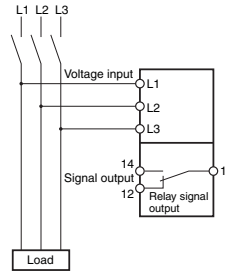

**Nomenclature**

**Front**

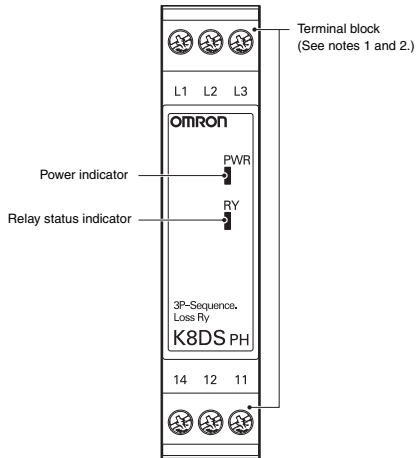

**●Indicators**

Item	Meaning
Power indicator (PWR: Green)	Lit when power is being supplied *3.
Relay status indicator (RY: Yellow)	Lit when relay is operating (normally lit).

\* The input across L1 and L2 is used for the internal power supply. Therefore, the power indicator will not be lit if there is no input across L1 and L2.

**Note: 1.** Use either a solid wire of 2.5 mm<sup>2</sup> maximum or a ferrule with insulating sleeve for the terminal connection. The length of the exposed current-carrying part inserted into the terminal must be 8 mm or less to maintain dielectric strength after connection.

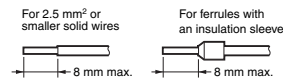

**Recommended ferrules**

**Phoenix Contact**

- Al 1,5-8BK (for AWG16)
- Al 1-8RD (for AWG18)
- Al 0,75-8GY (for AWG18)

**2.** Tightening torque: 0.49 N·m

**Operation and Setting Methods**

**●Connections**

1. **Input**  
Connect using L1, L2, and L3. Make sure the phase sequence is wired correctly. The Unit will not operate normally if the phase sequence is incorrect.
  2. **Outputs**  
Terminals 11, 12, and 14 are the output terminals SPDT.
- \* Use the recommended ferrules if you use twisted wires.

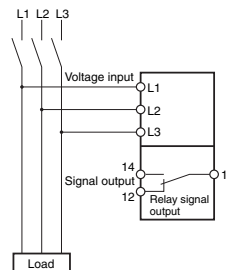

# Datenblatt

## Spannungsüberwachungsrelais K8DS-PM

K8DS-PM



### K8DS-PH

(Unit: mm)

#### Dimensions

##### ●Phase-sequence Phase-loss Relay

K8DS-PH1

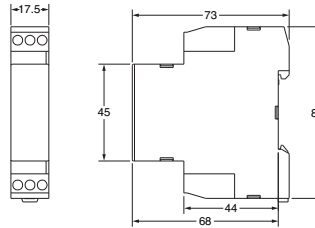

#### Optional Parts for DIN Track Mounting

##### ●DIN Tracks

PFP-100N

PFP-50N

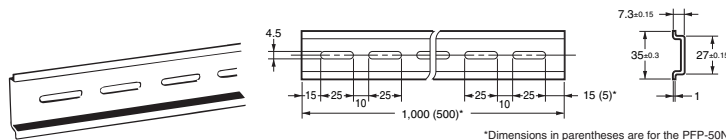

\*Dimensions in parentheses are for the PFP-50N.

K8DS-PH

Questions and Answers

**Q** Checking Operation

**A** Phase Sequence  
Switch the wiring, as shown by the dotted lines in the connection diagram, to reverse the phase sequence and check that the K8DS operates.  
Phase Loss  
Create a phase loss for any input phase and check that the K8AK operates.

Connection Diagram

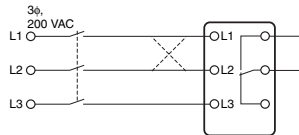

**Q** Can phase loss be detected on the load side?

**A** In principle, phase loss cannot be detected on the load side because the K8DS-PH measures three-phase voltage to determine phase loss.

**Q** Is it possible to detect phase losses for motor loads while the motor is operating?

**A** Phase loss can be detected while the motor is operating. However, the detection conditions depend on the load conditions that are shown in the following figure. Understand these characteristics when using this feature.

Normally, three-phase motors will continue to rotate even if one phase is open. The three-phase voltage will be induced at the motor terminals. The diagram shows voltage induction at the motor terminals when phase R has been lost with a load applied to a three-phase motor. The horizontal axis shows the motor load as a percentage of the rated load, and the vertical axis shows voltage as a percentage of the rated voltage. The solid line in this graph shows the voltage that is induced at the motor terminals when a phase loss occurs while the motor is operating under various loads. The figure below shows how a phase loss that occurs while the motor is operating causes an imbalance in the voltage across each motor terminal. The K8DS-PH1 detects phase loss when the motor is operating when the voltage is unbalanced. (Detection occurs when the imbalance is 80% of the maximum phase). The K8DS-PH1 cannot detect phase loss with light motor loads because the voltage imbalance is too small. The detectable range is shown by the diagonal lines.

Characteristic Curve Diagram

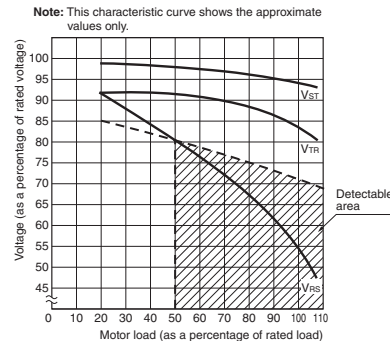

Note: For phase loss of phase R. V<sub>st</sub>, V<sub>tr</sub>, and V<sub>rs</sub> indicate the motor terminal voltage at phase loss.

## Phase-sequence Phase-loss Relay **K8AK-PH**

### Three-phase Phase-sequence Phase-loss Relay Using Voltage Detection Method

- Greater resistance to inverter noise. *NEW*
- Distinguishes between positive phases, reversed phases, and phase loss when power is turned ON.
- Supports phase loss detection when the motor is operating.
- 5 A (resistive load) at 250 VAC, DPDT x 1.
- Output status can be monitored using LED indicator.
- Ideal to prevent reverse operation of motors.
- RoHS-compliant.

Refer to *Safety Precautions for the K8AK Series* on page 86. Refer to page 50 for commonly asked questions.



For the most recent information on models that have been certified for safety standards, refer to your OMRON website.

### Ordering Information

#### List of Models

Function	Rated input voltage*	Relay output	Model
Phase sequence and phase loss monitoring	3-phase, 3-wire 200 to 480 VAC	DPDT x1	<b>K8AK-PH1</b>

\* The power supply is shared with the rated input voltage.

## K8AK-PH

### Ratings and Specifications

#### Ratings

<b>Rated input voltage</b>	3-phase, 200 to 480 VAC (3-wire)
<b>Input load</b>	Approx. 4.1 VA
<b>Reversed phase and phase loss operating time</b>	0.1 s max.
<b>Reset method</b>	Automatic reset
<b>Indicators</b>	Power (PWR): Green, Relay output (RY): Yellow
<b>Output relays</b>	One DPDT relay (NC operation)
<b>Output relay ratings</b>	Rated load Resistive load 5 A at 250 VAC 5 A at 30 VDC Max. switching voltage 250 VAC or 30 VDC Max. switching current: 5 A Minimum load: 24 VDC, 40 mA Mechanical life: 10 million operations min. Electrical life: 5 A at 250 VAC or 30 VDC: 50,000 operations 3 A at 250 VAC/30 VDC: 100,000 operations
<b>Ambient operating temperature</b>	-20 to 60°C (with no condensation or icing)
<b>Storage temperature</b>	-25 to 65°C (with no condensation or icing)
<b>Ambient operating humidity</b>	25% to 85% (with no condensation)
<b>Storage humidity</b>	25% to 85% (with no condensation)
<b>Altitude</b>	2,000 m max.
<b>Terminal screw tightening torque</b>	0.49 N·m
<b>Terminal wiring method</b>	Recommended wire Solid wire: 2.5 mm <sup>2</sup> Twisted wires: AWG16, AWG18 <b>Note:</b> 1. Ferrules with insulating sleeves must be used with twisted wires. 2. Two wires can be twisted together. Recommended ferrules Al 1,5-8BK (for AWG16) manufactured by Phoenix Contact Al 1-8RD (for AWG18) manufactured by Phoenix Contact Al 0,75-8GY (for AWG18) manufactured by Phoenix Contact
<b>Case color</b>	N1.5
<b>Case material</b>	PC and ABS
<b>Weight</b>	Approx. 130 g
<b>Mounting</b>	Mounts to DIN Track.
<b>Dimensions</b>	22.5 × 90 × 100 mm (W×H×D)

K8AK-PH

**Specifications**

<b>Input voltage range</b>	200 to 480 VAC	
<b>Input frequency</b>	50/60 Hz (no presumed range)	
<b>Overload capacity</b>	Continuous 528 V	
<b>Applicable standards</b>	<b>Conforming standards</b>	EN60947-5-1 Installation environment (pollution level 2, installation category III)
	<b>EMC</b>	EN60947-5-1
	<b>Safety standards</b>	UL 508 (Recognition), Korean Radio Waves Act (Act 10564), CSA: CAN/CSA C22.2 No.14, CCC: GB14048.5
<b>Insulation resistance</b>	20 MΩ min. Between external terminals and case Between input terminals and output terminals	
<b>Dielectric strength</b>	2,000 VAC for one minute Between external terminals and case Between input terminals and output terminals	
<b>Noise immunity</b>	1,500 V power supply terminal common/normal mode Square-wave noise of ±1 μs/100 ns pulse width with 1-ns rise time	
<b>Vibration resistance</b>	Frequency: 10 to 55 Hz, acceleration 50 m/s <sup>2</sup> 10 sweeps of 5 min each in X, Y, and Z directions	
<b>Shock resistance</b>	150 m/s <sup>2</sup> , 3 times each in 6 directions along 3 axes However, 100 m/s <sup>2</sup> for relay contacts.	
<b>Degree of protection</b>	Terminals: IP20	

**●Relationship of Mounting Distance between K8AK-PH Relays and Ambient Temperature (Reference Values)**

The following diagram shows the relationship between the mounting distances and the ambient temperature.  
If the relay is used with an ambient temperature that exceeds these values, the temperature of the K8AK may rise and shorten the life of the internal components.

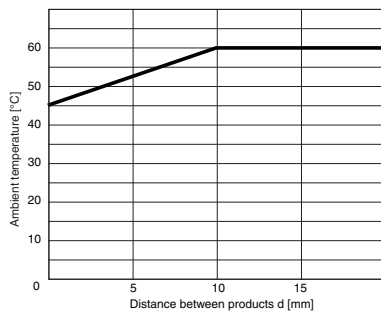

**Test method**

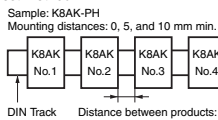



**K8AK-PH**

**Connections**

**Wiring Diagram**

**●Phase Sequence and Phase Loss Operation Diagram**

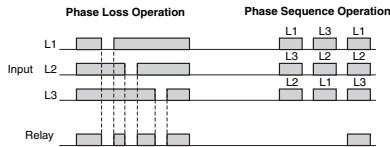

- Note:**
1. The K8AK-PH1 output contacts are normally operative.
  2. The Relay will not operate if the input voltage drops below 70% of the minimum input value because L1 and L2 are also used to provide power.
  3. Phase loss cannot be detected on the load side because this detection is based on the voltage.

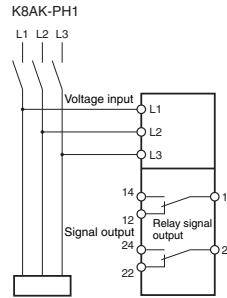

**Nomenclature**

**Front**

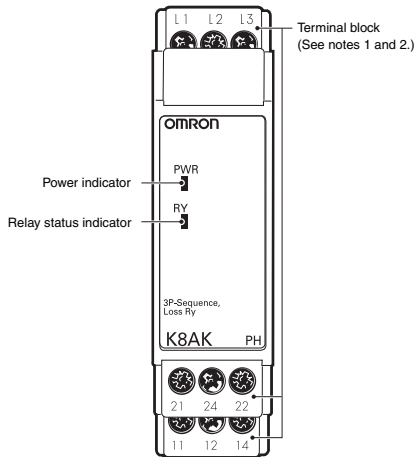

**●Indicators**

Item	Meaning
Power indicator (PWR: Green)	Lit when power is being supplied *3.
Relay status indicator (RY: Yellow)	Lit when relay is operating (normally lit).

\* The input across L1 and L2 is used for the internal power supply. Therefore, the power indicator will not be lit if there is no input across L1 and L2.

**Note: 1.** Use either a solid wire of 2.5 mm<sup>2</sup> maximum or a ferrule with insulating sleeve for the terminal connection. The length of the exposed current-carrying part inserted into the terminal must be 8 mm or less to maintain dielectric strength after connection.

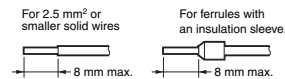

**Recommended ferrules**

- Phoenix Contact
- Al 1,5-8BK (for AWG16)
  - Al 1-8RD (for AWG18)
  - Al 0,75-8GY (for AWG18)

**2.** Tightening torque: 0.49 N·m

**Operation and Setting Methods**

**●Connections**

1. **Input**  
Connect using L1, L2, and L3. Make sure the phase sequence is wired correctly. The Unit will not operate normally if the phase sequence is incorrect.
  2. **Outputs**  
Terminals 11, 12, and 14 are the output terminals (SPDT) for overvoltage.  
Terminals 21, 22, and 24 are the output terminals (SPDT) for undervoltage, phase loss, and reversed phase outputs.
- \* Use the recommended ferrules if you use twisted wires.

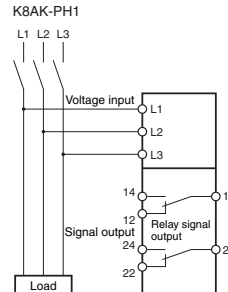

**K8AK-PH**

(Unit: mm)

**Dimensions**

●Phase-sequence Phase-loss Relays

K8AK-PH1

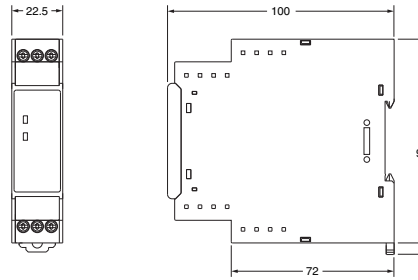

**Optional Parts for DIN Track Mounting**

●DIN Tracks

PFP-100N

PFP-50N

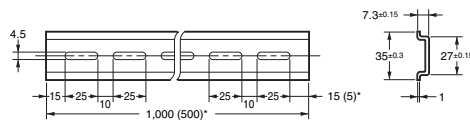
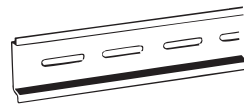

\*Dimensions in parentheses are for the PFP-50N.

K8AK-PH

Questions and Answers

**Q** Checking Operation

**A** Phase Sequence  
Switch the wiring, as shown by the dotted lines in the connection diagram, to reverse the phase sequence and check that the K8AK operates.  
Phase Loss  
Create a phase loss for any input phase and check that the K8AK operates.

Connection Diagram

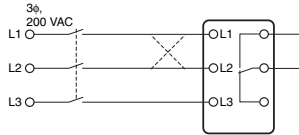

**Q** Can phase loss be detected on the load side?

**A** In principle, phase loss cannot be detected on the load side because the K8AK-PH measures three-phase voltage to determine phase loss.

**Q** Is it possible to detect phase losses for motor loads while the motor is operating?

**A** Phase loss can be detected while the motor is operating. However, the detection conditions depend on the load conditions that are shown in the following figure. Understand these characteristics when using this feature.

Normally, three-phase motors will continue to rotate even if one phase is open. The three-phase voltage will be induced at the motor terminals. The diagram shows voltage induction at the motor terminals when phase R has been lost with a load applied to a three-phase motor. The horizontal axis shows the motor load as a percentage of the rated load, and the vertical axis shows voltage as a percentage of the rated voltage. The solid line in this graph shows the voltage that is induced at the motor terminals when a phase loss occurs while the motor is operating under various loads. The figure below shows how a phase loss that occurs while the motor is operating causes an imbalance in the voltage across each motor terminal. The K8AK-PH detects phase loss when the motor is operating when the voltage is unbalanced. (Detection occurs when the imbalance is 80% of the maximum phase). The K8AK-PH cannot detect phase loss with light motor loads because the voltage imbalance is too small. The detectable range is shown by the diagonal lines.

Characteristic Curve Diagram

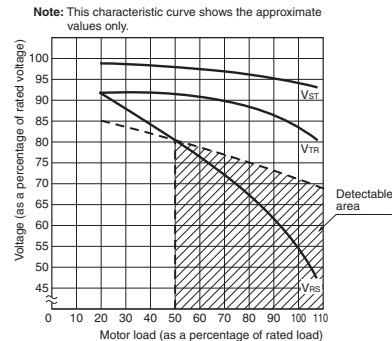

Note: For phase loss of phase R. V<sub>st</sub>, V<sub>tr</sub>, and V<sub>rs</sub> indicate the motor terminal voltage at phase loss.

## Three-phase Voltage Relay K8AK-PW

**Ideal for monitoring 3-phase power supplies for industrial facilities and equipment.**

- Greater resistance to inverter noise. *NEW*
- Monitor overvoltages and undervoltages for three-phase 3-wire or 4-wire power supplies.  
DIP switch setting for 3-phase 3-wire or 3-phase 4-wire power supply.
- Two SPDT output relays, 5 A at 250 VAC (resistive load). Separate outputs possible for overvoltages and undervoltages.
- World-wide power specifications supported by one Unit (switchable using DIP switch).
- Relay status can be monitored using LED indicator.
- RoHS-compliant.



For the most recent information on models that have been certified for safety standards, refer to your OMRON website.

⚠ Refer to *Safety Precautions for All Temperature Controllers*.  
Refer to 57 for commonly asked questions.

● **Single K8AK Monitors 3-phase Power Supply with 3 or 4 Wires**

Monitoring Relays can be used to monitor 3-phase power supplies with 3 or 4 wires simply by changing DIP switch settings.

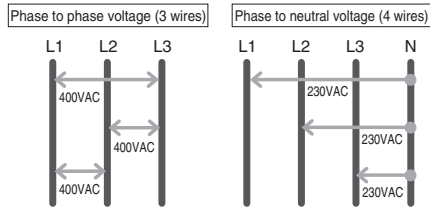

**A Single K8AK Can Monitor a 3-phase Power Supply Anywhere in the World**

Reduces Maintenance Parts Inventory

	SW3		ON		OFF		OFF	
	SW4		ON	OFF	ON	OFF	ON	OFF
K8AK-PW1	SW2	ON	P-N	138 V	133 V	127 V	115 V	
		OFF	P-P	240V	230 V	220 V	200 V	
K8AK-PW2	SW2	ON	P-N	277 V	240 V	230 V	220 V	
		OFF	P-P	480 V	415 V	400 V	380 V	

## K8AK-PW

### Ordering Information

#### List of Models

Rated input*		Model
3-phase 3-wire mode	200, 220, 230, 240 VAC	K8AK-PW1
3-phase 4-wire mode	115, 127, 133, 138 VAC	
3-phase 3-wire mode	380, 400, 415, 480 VAC	K8AK-PW2
3-phase 4-wire mode	220, 230, 240, 277 VAC	

**Note:** Three-phase, three-wire or four-wire and the input range are switched using a DIP switch.  
 \* The power supply voltage is the same as the rated input voltage.

### Ratings and Specifications

#### Ratings

Rated input voltage	K8AK-PW1	Three-phase, three-wire Mode: 200, 220, 230 and 240 VAC Three-phase, four-wire Mode: 115, 127, 133 and 138 VAC
	K8AK-PW2	Three-phase, three-wire Mode: 380, 400, 415 and 480 VAC Three-phase, four-wire Mode: 220, 230, 240 and 277 VAC
Input load	K8AK-PW1: Approx. 4.4 VA K8AK-PW2: Approx. 4.4 VA	
Operating value setting range (OVER, UNDER)	Overvoltage -30% to 25% of rated input voltage Undervoltage -30% to 25% of rated input voltage <b>Note:</b> The rated input voltage can be switched using the DIP switch.	
Operating value	100% operation at set value	
Reset value	5% of operating value (fixed)	
Reset method	Automatic reset	
Operating time setting range (T)	Overvoltage and undervoltage: 0.1 to 30 s	
Startup lock time (LOCK)	1 s/5 s (Changed with the DIP switch.)	
Indicators	Power (PWR): Green, Relay output (RY): Yellow, OVER/UNDER: Red	
Output relays	Two SPDT relays (NC operation)	
Output relay ratings	Rated load Resistive load 5 A at 250 VAC 5 A at 30 VDC Maximum contact voltage: 250 VAC or 30 VDC Max. switching current: 5 A Maximum switching capacity: 1,250 VA, 150 W Mechanical life: 10 million operations min. Electrical life: 5 A at 250 VAC or 30 VDC:50,000 operations 3 A at 250 VAC/30 VDC:100,000 operations	
Ambient operating temperature	-20 to 60°C (with no condensation or icing)	
Storage temperature	-25 to 65°C (with no condensation or icing)	
Ambient operating humidity	25% to 85% (with no condensation)	
Storage humidity	25% to 85% (with no condensation)	
Altitude	2,000 m max.	
Terminal screw tightening torque	0.49 N·m	
Terminal wiring method	Recommended wire Solid wire: 2.5 mm <sup>2</sup> Twisted wires: AWG16, AWG18 <b>Note:</b> 1. Ferrules with insulating sleeves must be used with twisted wires. 2. Two wires can be twisted together. Recommended ferrules Al 1.5-8BK (for AWG16) manufactured by Phoenix Contact Al 1-8RD (for AWG18) manufactured by Phoenix Contact Al 0.75-8GY (for AWG18) manufactured by Phoenix Contact	
Case color	N1.5	
Case material	PC and ABS	
Weight	Approx. 150 g	
Mounting	Mounts to DIN Track.	
Dimensions	22.5 × 90 × 100 mm (W×H×D)	

K8AK-PW

Specifications

<b>Input frequency range</b>	50/60 Hz
<b>Overload capacity</b>	Continuous input at 115% of maximum input. 10 s at 125%. (up to 600 VAC)
<b>Repeat accuracy</b>	<b>Operating value</b>
	<b>Operating time</b>
<b>Applicable standards</b>	<b>Conforming standards</b>
	<b>EMC</b>
	<b>Safety standards</b>
<b>Insulation resistance</b>	20 MΩ Between all external terminals and the case Between all input terminals and all output terminals
<b>Dielectric strength</b>	2,000 VAC for 1 min Between all external terminals and the case Between all input terminals and all output terminals
<b>Noise immunity</b>	1,500 V power supply terminal common/normal mode Square-wave noise of ±1 μs/100 ns pulse width with 1-ns rise time
<b>Vibration resistance</b>	Frequency: 10 to 55 Hz, acceleration 50 m/s <sup>2</sup> 10 sweeps of 5 min each in X,Y, and Z directions
<b>Shock resistance</b>	150 m/s <sup>2</sup> , 3 times each in 6 directions along 3 axes However, 100 m/s <sup>2</sup> for relay contacts.
<b>Degree of protection</b>	Terminals: IP20

● Relationship of Mounting Distance between K8AK-PW Relays and Ambient Temperature (Reference Values)

The following diagram shows the relationship between the mounting distances and the ambient temperature.  
If the relay is used with an ambient temperature that exceeds these values, the temperature of the K8AK may rise and shorten the life of the internal components.

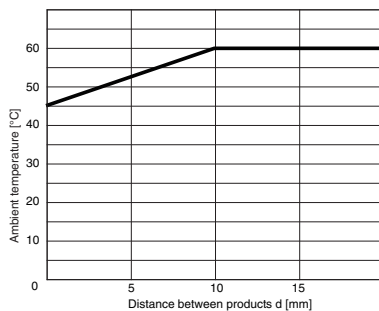

Test method

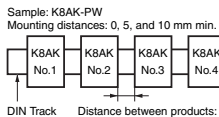

**K8AK-PW**

**Connections**

**Wiring Diagram**

**●Overvoltage and Undervoltage Operation Diagram**

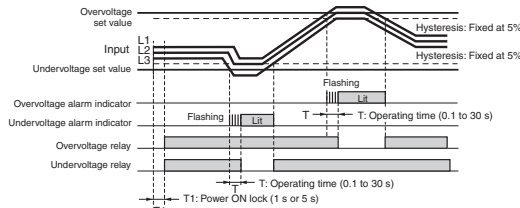

- Note:** 1. K8AK-PW output relay is normally operative.  
 2. The power ON lock function prevents unnecessary alarms from being generated during the unstable period when the power is first turned ON. There is no relay output during

**Nomenclature**

**Front**

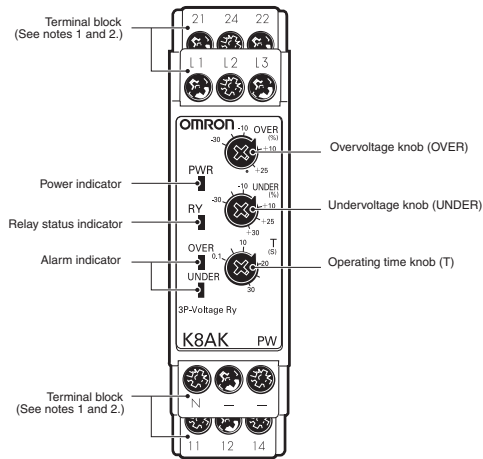

timer operation.

3. L1 and L2 use the same power supply and will not operate due to an undervoltage if they drop below the rated input of 60%.

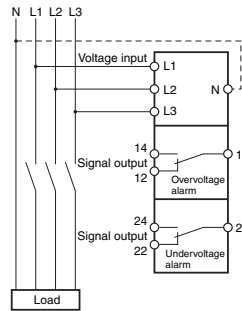

**●Indicators**

Item	Meaning
Power indicator (PWR: Green)	Lit when power is being supplied*
Relay status indicator (RY: Yellow)	Lit when relay is operating (normally lit).
Alarm indicator (ALM: Red)	Overvoltage: Lit when there is an overvoltage. The indicator flashes to indicate the error status after the overvoltage has exceeded the set value while the operating time is being clocked.
	Undervoltage: Lit when there is an undervoltage or phase loss. The indicator flashes to indicate the error status after the undervoltage has exceeded the set value while the operating time is being clocked.

\* The input across L1 and L2 is used for the internal power supply. Therefore, the power indicator will not be lit if there is no input across L1 and L2.

**●Setting Knobs**

Item	Usage
Overvoltage knob (OVER)	Can be set between -30% and 25% of the rated input.
Undervoltage knob (UNDER)	Can be set between -30% and 25% of the rated input.
Operating time knob (T)	Used to set the operating time to 0.1 to 30 s.

- Note: 1.** Use either a solid wire of 2.5 mm<sup>2</sup> maximum or a ferrule with insulating sleeve for the terminal connection. The length of the exposed current-carrying part inserted into the terminal must be 8 mm or less to maintain dielectric strength after connection.

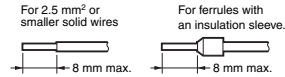

**Recommended ferrules**

- Phoenix Contact
- Al 1,5-8BK (for AWG16)
- Al 1-8RD (for AWG18)
- Al 0,75-8GY (for AWG18)

2. Screw tightening torque: 0.49 N·m max.

K8AK-PW

Operation and Setting Methods

●Connections

1. Input  
Connect to L1, L2, and L3 (for three-phase three-wire mode) or L1, L2, L3, and N (for three-phase four-wire mode), depending on the mode selected using pin 2 on the DIP switch.  
The Unit will not operate correctly if the DIP switch setting and the wiring do not agree.  
Make sure the phase sequence is wired correctly. The Unit will not operate normally if the phase sequence is incorrect.
  2. Outputs  
Terminals 11, 12, and 14 are the output terminals for overvoltage (SPDT).  
Terminals 21, 22, and 24 are the output terminals for undervoltage (SPDT).
- \* Use the recommended ferrules if you use twisted wires.

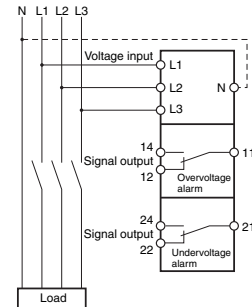

●DIP Switch Settings

The Startup lock time, number of wires, and rated voltage are set using the DIP switch located on the bottom of the Unit.

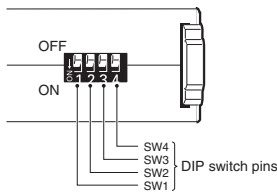

DIP Switch Functions

K8AK-PW1

Pin	OFF ● ↑ ON ○ ↓	DIP Switch Settings				
		1	2	3	4	
Power ON lock time	1 s	●	---	---	---	
	5 s	○	---	---	---	
Number of wires	3-wire 3-phase	---	●	---	---	
	4-wire 3-phase	---	○	---	---	
Rated voltage	3-wire 3-phase					
	200 V	115 V	---	---	●	●
	220 V	127 V	---	---	○	●
	230 V	133 V	---	---	●	○
	240 V	138 V	---	---	○	○

Note: All pins are set to OFF at the factory.

K8AK-PW2

Pin	OFF ● ↑ ON ○ ↓	DIP Switch Settings				
		1	2	3	4	
Power ON lock time	1 s	●	---	---	---	
	5 s	○	---	---	---	
Number of wires	3-wire 3-phase	---	●	---	---	
	4-wire 3-phase	---	○	---	---	
Rated voltage	3-wire 3-phase					
	380 V	220 V	---	---	●	●
	400 V	230 V	---	---	○	●
	415 V	240 V	---	---	●	○
	480 V	277 V	---	---	○	○

Note: All pins are set to OFF at the factory.



## K8AK-PW

### ●Setting Method

1. Overvoltage
 

The overvoltage knob (OVER) is used to set the overvoltage.  
 The overvoltage can be set to between -30% and 25% of the rated input voltage.  
 Turn the knob while there is an input to the input terminals until the alarm indicator flashes (when the set value and the input have reached the same level.)  
 Use this as a guide to set the voltage.  
 The rated input depends on the model and DIP switch setting.  
 Example: K8AK-PW1 with Pin 2 Turned OFF (Three-phase, Three-wire Mode) and Pins 3 and 4 Turned OFF (Rated Voltage of 200 V)  
 The rated input voltage is 200 VAC and the setting range is 140 to 250 V.
2. Undervoltage
 

Undervoltage is set using the undervoltage knob (UNDER).  
 The undervoltage can be set to between -30% and 25% of the rated input.  
 Turn the knob while there is an input to the input terminals until the alarm indicator flashes (when the set value and the input have reached the same level.)  
 Use this as a guide to set the voltage.  
 The rated input depends on the model and DIP switch setting.  
 Example: K8AK-PM1 with Pin 2 Turned OFF (Three-phase, Three-wire Mode) and Pins 3 and 4 Turned OFF (Rated Voltage of 200 V)  
 The rated input voltage is 200 VAC and the setting range is 140 to 250 V.
3. Operating Time
 

The operating time is set using the operating time knob (T).  
 The operating time can be set to between 0.1 and 30 s.  
 Turn the knob while there is an input to the input terminals until the alarm indicator flashes (when the set value and the input have reached the same level.)  
 Use this as a guide to set the current.  
 If the input exceeds (or drops lower than) the voltage set value, the alarm indicator will start flashing for the set period and then stay lit.

### Dimensions

(Unit: mm)

### Three-phase Voltage Relay

K8AK-PW1  
K8AK-PW2

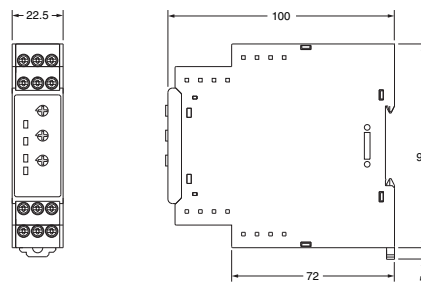

### Optional Parts for DIN Track Mounting

#### ●DIN Tracks

PFP-100N  
PFP-50N

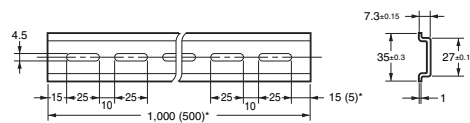
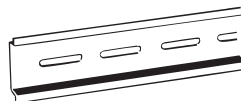

\*Dimensions in parentheses are for the PFP-50N.

K8AK-PW

Questions and Answers

**Q** Checking Operation

**A** **Overvoltage**  
 Gradually increase the input from 80% of the set value. The input value will equal the operating value when the input exceeds the set value and the alarm indicator starts flashing. Operation can be checked by the relay output that will start after the operating time has passed.  
**Undervoltage**  
 Gradually decrease the input from 120% of the set value and check the operation using the same method as for overvoltage.

Example: For monitoring mode set to three-phase three-wire monitoring, a rated voltage of 200 V, and an operating time of 5 s.

Note: K8AK-PW output relays are normally operative.

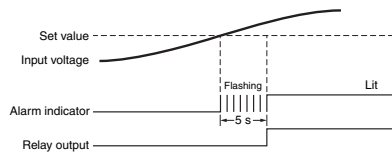

Connection Diagram

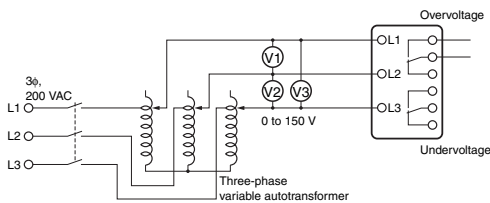

**Q** How to Measure the Operating Time

**A** **Overvoltage**  
 Change the input suddenly from 0% to 120% of the set value and measure the time until the Unit operates.  
**Undervoltage**  
 Change the input suddenly from 120% to 0% of the set value and measure the time until the Unit operates.  
**Operating Time**  
 Adjust the slide resistor so that the voltage applied to the K8AK terminals is 120% of the overvoltage set value or 80% of the undervoltage set value when the auxiliary relay operates in a test circuit. Close the switch and use the cycle counter to measure the operating time.

Connection Diagram

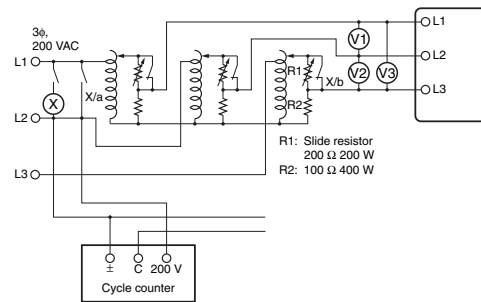

**Q** Overvoltage Detection When Only One Phase Exceeds the Overvoltage Set Value

**A** The K8AK monitors each of the three-phase voltages. This means an overvoltage is detected even if only one phase exceeds the set value. The same applies to undervoltages.

# Three-phase Phase-sequence Phase-loss Relay K8AK-PM

**Ideal for monitoring 3-phase power supplies for industrial facilities and equipment.**



- Greater resistance to inverter noise. *NEW*
- Monitor overvoltages, undervoltages, phase sequence, and phase loss for three-phase 3-wire or 4-wire power supplies with just one Unit.  
Switch setting for 3-phase 3-wire or 3-phase 4-wire power supply.
- Two SPDT output relays, 5 A at 250 VAC (resistive load).  
Output overvoltages and undervoltages using separate relays.
- World-wide power specifications supported by one Unit (switchable).
- Output status can be monitored using LED indicator.
- RoHS-compliant.



For the most recent information on models that have been certified for safety standards, refer to your OMRON website.

⚠ Refer to *Safety Precautions for the K8AK Series* on page 86.  
Refer to page 65 to 66 for commonly asked questions.

● **Single K8AK Monitors 3-phase Power Supply with 3 or 4 Wires**

Monitoring Relays can be used to monitor 3-phase power supplies with 3 or 4 wires simply by changing DIP switch settings.

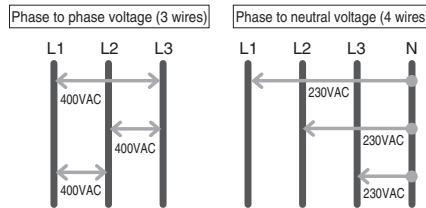

**A Single K8AK Can Monitor a 3-phase Power Supply Anywhere in the World**

Reduces Maintenance Parts Inventory

	SW3	ON	ON	OFF	OFF
	SW4	ON	OFF	ON	OFF
K8AK-PM1	ON	P-N	138 V	133 V	115 V
	OFF	P-P	240V	230 V	200 V
K8AK-PM2	ON	P-N	277 V	240 V	230 V
	OFF	P-P	480 V	415 V	380 V

K8AK-PM

Ordering Information

List of Models

Rated input*		Model
3-phase 3-wire mode	200, 220, 230, 240 VAC	K8AK-PM1
3-phase 4-wire mode	115, 127, 133, 138 VAC	
3-phase 3-wire mode	380, 400, 415, 480 VAC	K8AK-PM2
3-phase 4-wire mode	220, 230, 240, 277 VAC	

Note: Three-phase 3-wire or 4-wire and the input range are switched using a DIP switch.  
 \* The power supply is shared with the rated input voltage.

Ratings and Specifications

Ratings

Rated input voltage	K8AK-PM1	Three-phase, three-wire Mode: 200, 220, 230 and 240 VAC Three-phase, four-wire Mode: 115, 127, 133 and 138 VAC
	K8AK-PM2	Three-phase, three-wire Mode: 380, 400, 415 and 480 VAC Three-phase, four-wire Mode: 220, 230, 240 and 277 VAC
Input load		K8AK-PM1: Approx. 4.4 VA K8AK-PM2: Approx. 4.4 VA
Operating value setting range (OVER, UNDER)		Overvoltage -30% to 25% of rated input voltage Undervoltage -30% to 25% of rated input voltage Note: The rated input voltage can be switched using the DIP switch.
Operating value		100% operation at set value
Reset value		5% of operating value (fixed)
Reset method		Automatic reset
Operating time setting range (T)	Overvoltage/undervoltage	0.1 to 30 s
	Reversed phase/phase loss	0.1 s
Startup lock time (LOCK)		1 s or 5 s (Switched using DIP switch.)
Indicators		Power (PWR): Green, Relay output (RY): Yellow, OVER/UNDER: Red
Output relays		Two SPDT relays (NC operation)
Output relay ratings		Rated load Resistive load 5 A at 250 VAC 5 A at 30 VDC Maximum contact voltage: 250 VAC or 30 VDC Max. switching current: 5 A Maximum switching capacity: 1,250 VA, 150 W Mechanical life: 10 million operations min. Electrical life: 5 A at 250 VAC or 30 VDC: 50,000 operations 3 A at 250 VAC/30 VDC: 100,000 operations
Ambient operating temperature		-20 to 60°C (with no condensation or icing)
Storage temperature		-25 to 65°C (with no condensation or icing)
Ambient operating humidity		25% to 85% (with no condensation)
Storage humidity		25% to 85% (with no condensation)
Altitude		2,000 m max.
Terminal screw tightening torque		0.49 N·m
Terminal wiring method		Recommended wire Solid wire: 2.5 mm <sup>2</sup> Twisted wires: AWG16, AWG18 Note: 1. Ferrules with insulating sleeves must be used with twisted wires. 2. Two wires can be twisted together. Recommended ferrules Al 1.5-8BK (for AWG16) manufactured by Phoenix Contact Al 1-8RD (for AWG18) manufactured by Phoenix Contact Al 0.75-8GY (for AWG18) manufactured by Phoenix Contact
Case color		N1.5
Case material		PC and ABS
Weight		Approx. 150 g
Mounting		Mounts to DIN Track.
Dimensions		22.5 x 90 x 100 mm (W×H×D)

## K8AK-PM

### Specifications

<b>Input frequency</b>	50/60 Hz
<b>Overload capacity</b>	Continuous input at 115% of maximum input, 10 s at 125% (up to 600 VAC).
<b>Repeat accuracy</b>	<b>Operating value</b>
	<b>Operating time</b>
<b>Applicable standards</b>	<b>Conforming standards</b>
	<b>EMC</b>
	<b>Safety standards</b>
<b>Insulation resistance</b>	20 MΩ Between all external terminals and the case Between all input terminals and all output terminals
<b>Dielectric strength</b>	2,000 VAC for 1 min Between all external terminals and the case Between all input terminals and all output terminals
<b>Noise immunity</b>	1,500 V power supply terminal common/normal mode Square-wave noise of ±1 μs/100 ns pulse width with 1-ns rise time
<b>Vibration resistance</b>	Frequency: 10 to 55 Hz, acceleration 50 m/s <sup>2</sup> 10 sweeps of 5 min each in X,Y, and Z directions
<b>Shock resistance</b>	150 m/s <sup>2</sup> , 3 times each in 6 directions along 3 axes However, 100 m/s <sup>2</sup> for relay contacts.
<b>Degree of protection</b>	Terminals: IP20

### ●Relationship of Mounting Distance between K8AK-PM Relays and Ambient Temperature (Reference Values)

The following diagram shows the relationship between the mounting distances and the ambient temperature.

If the relay is used with an ambient temperature that exceeds these values, the temperature of the K8AK may rise and shorten the life of the internal components.

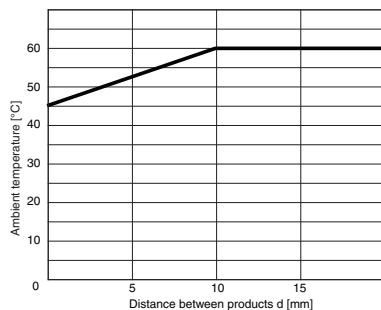

#### Test method

Sample: K8AK-PM

Mounting distances: 0, 5, and 10 mm min.

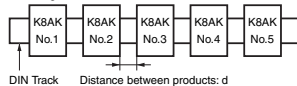

K8AK-PM

Connections

Wiring Diagram

● Overvoltage/Undervoltage and Phase Sequence/Phase Loss Operation Diagram

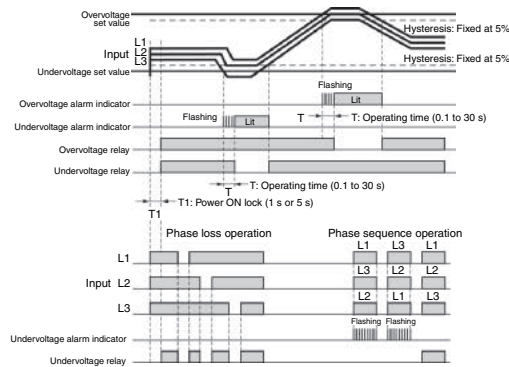

- Note:**
1. The K8AK-PM output relay is normally operative.
  2. The power ON lock prevents unnecessary alarms from being generated during the instable period when the power is first turned on. There is no relay output during timer operation.
  3. Phase loss is detected by L1, L2, and L3 voltage drops. A phase loss will exist if any of the phases drops below 60% of the rated input.

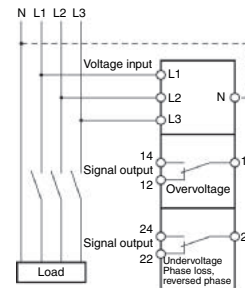

Operation Indicators

Item	Display			Contact operation	
	Ry indicator	Over indicator	Under indicator	Over relay	Under relay
<b>Overvoltage</b>	ON	ON	OFF	OFF	ON
<b>Undervoltage</b>	ON	OFF	ON	ON	OFF
<b>Phase loss</b>	OFF	OFF*1	ON	OFF *1	OFF
<b>Reversed phase</b>	ON	OFF	Flashing*2	ON	OFF
<b>Correct phase</b>	ON	OFF	OFF	ON	ON

\*1 While phase loss is detected, Over\_Ry will also be OFF.

\*2 The indicator will flash once per second after a phase loss is detected and once per 0.5 second during the detection time.

**K8AK-PM**

**Nomenclature**

**Front**

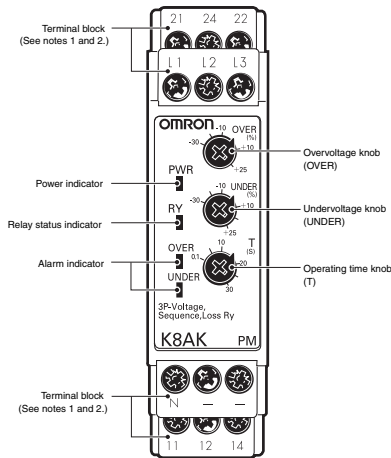

**●Indicators**

Item	Meaning
Power indicator (PWR: Green)	Lit when power is being supplied*
Relay status indicator (RY: Yellow)	Lit when relay is operating (normally lit).
Alarm indicator	Overvoltage: Red The indicator flashes to indicate the error status after the overvoltage has exceeded the set value while the operating time is being clocked.
	Undervoltage: Red • Lit when there is an undervoltage or phase loss. The indicator flashes to indicate the error status after the undervoltage has exceeded the set value while the operating time is being clocked. • Lit when there is a phase sequence error.

\* The input across L1 and L2 is used for the internal power supply. Therefore, the power indicator will not be lit if there is no input across L1 and L2.

**●Setting Knobs**

Item	Usage
Overvoltage knob (OVER)	Can be set between -30% and 25% of the rated input.
Undervoltage knob (UNDER)	Can be set between -30% and 25% of the rated input.
Operating time knob (T)	Used to set the operating time to 0.1 to 30 s.

**Note: 1.** Use either a solid wire of 2.5 mm<sup>2</sup> maximum or a ferrule with insulating sleeve for the terminal connection. The length of the exposed current-carrying part inserted into the terminal must be 8 mm or less to maintain dielectric strength after connection.

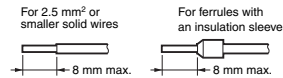

Recommended ferrules  
Phoenix Contact

- Al 1,5-8BK (for AWG16)
- Al 1-8RD (for AWG18)
- Al 0,75-8GY (for AWG18)

2. Screw tightening torque: 0.49 N·m max.

## K8AK-PM

### Operation and Setting Methods

#### ●Connections

- Input**  
Connect to L1, L2, and L3 (for three-phase three-wire mode) or L1, L2, L3, and N (for three-phase four-wire mode), depending on the mode selected using pin 2 on the DIP switch.  
The Unit will not operate correctly if the DIP switch setting and the wiring do not agree.  
Make sure the phase sequence is wired correctly. The Unit will not operate normally if the phase sequence is incorrect.
  - Outputs**  
Terminals 11, 12, and 14 are the output terminals for overvoltage (SPDT).  
Terminals 21, 22, and 24 are the output terminals for undervoltage, phase loss, and reversed phase (SPDT).
- \* Use the recommended ferrules if you use twisted wires.

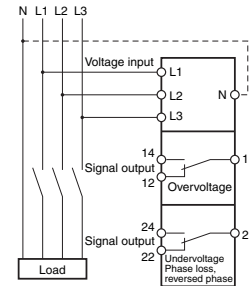

#### ●DIP Switch Settings

The power ON lock time, number of wires, and rated voltage are set using the DIP switch located on the bottom of the Unit.

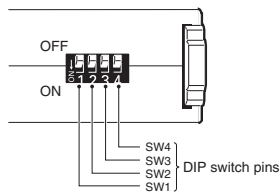

### DIP Switch Functions

#### K8AK-PM1

Pin		DIP Switch Settings					
		OFF ● ↑	ON ○ ↓	1	2	3	4
Power ON lock time	1 s	●	○	○	○	○	○
	5 s	○	●	○	○	○	○
Number of wires	3-wire 3-phase	○	○	●	○	○	○
	4-wire 3-phase	○	○	○	○	○	○
Rated voltage	3-wire 3-phase						
	4-wire 3-phase						
	200 V	115 V	○	○	○	○	○
	220 V	127 V	○	○	○	○	○
	230 V	133 V	○	○	○	○	○
240 V	138 V	○	○	○	○	○	

Note: All pins are set to OFF at the factory.

#### K8AK-PM2

Pin		DIP Switch Settings					
		OFF ● ↑	ON ○ ↓	1	2	3	4
Power ON lock time	1 s	●	○	○	○	○	○
	5 s	○	●	○	○	○	○
Number of wires	3-wire 3-phase	○	○	○	○	○	○
	4-wire 3-phase	○	○	○	○	○	○
Rated voltage	3-wire 3-phase						
	4-wire 3-phase						
	380 V	220 V	○	○	○	○	○
	400 V	230 V	○	○	○	○	○
	415 V	240 V	○	○	○	○	○
480 V	277 V	○	○	○	○	○	

Note: All pins are set to OFF at the factory.



### K8AK-PM

#### ●Setting Method

1. Overvoltage
 

The overvoltage knob (OVER) is used to set the overvoltage threshold.  
 The overvoltage can be set to between -30% and 25% of the rated input voltage.  
 Turn the knob while there is an input to the input terminals until the alarm indicator flashes (when the set value and the input have reached the same level.)  
 Use this as a guide to set the voltage.  
 The rated input depends on the model and DIP switch setting.  
 Example: K8AK-PM1 with Pin 2 Turned OFF (Three-phase, Three-wire Mode) and Pins 3 and 4 Turned OFF (Rated Voltage of 200 V)  
 The rated input voltage is 200 VAC and the setting range is 140 to 250 V.
2. Undervoltage
 

Undervoltage is set using the undervoltage knob (UNDER).  
 The undervoltage can be set to between -30% and 25% of the rated input.  
 Turn the knob while there is an input to the input terminals until the alarm indicator flashes (when the set value and the input have reached the same level.)  
 Use this as a guide to set the voltage.  
 The rated input depends on the model and DIP switch setting.  
 Example: K8AK-PM1 with Pin 2 Turned OFF (Three-phase, Three-wire Mode) and Pins 3 and 4 Turned OFF (Rated Voltage of 200 V)  
 The rated input voltage is 200 VAC and the setting range is 140 to 250 V.
3. Operating Time
 

The operating time is set using the operating time knob (T).  
 The operating time can be set to between 0.1 and 30 s.  
 Turn the knob while there is an input to the input terminals until the alarm indicator flashes (when the set value and the input have reached the same level.)  
 Use this as a guide to set the operating time.  
 If the input exceeds (or drops lower than) the voltage set value, the alarm indicator will start flashing for the set period and then stay lit.

#### Dimensions

(Unit: mm)

#### ●Three-phase Voltage with Phase-sequence Phase-loss Relay

K8AK-PM1  
K8AK-PM2

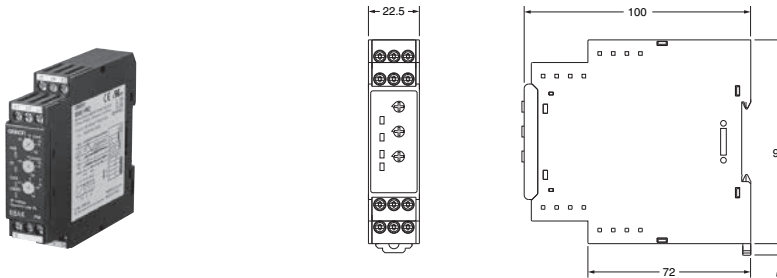

#### Optional Parts for DIN Track Mounting

##### ●DIN Tracks

PPF-100N  
PPF-50N

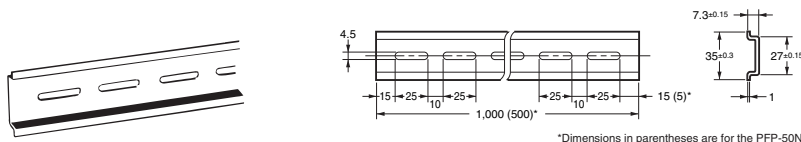

K8AK-PM

Questions and Answers

**Q** Checking Operation

**A** **Overvoltages**  
Gradually increase the input from 80% of the set value. The input value will equal the operating value when the input exceeds the set value and the alarm indicator starts flashing. Operation can be checked by the relay output that will start after the operating time has passed.

**Undervoltage**  
Gradually decrease the input from 120% of the set value and check the operation using the same method as for overvoltage.

**Example:** For monitoring mode set to three-phase three-wire monitoring, a rated voltage of 200 V, and an operating time of 5 s.

**Note:** K8AK-PM□ output relays are normally operative.

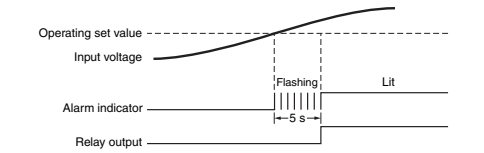

Connection Diagram 1

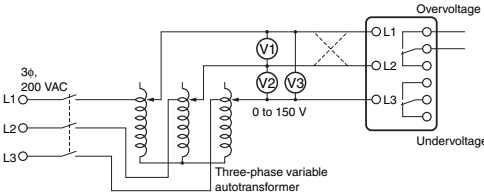

**Q** How to Measure the Operating Time

**A** **Overvoltage**  
Change the input suddenly from 0% to 120% of the set value and measure the time until the Unit operates.  
**Undervoltage**  
Change the input suddenly from 120% to 0% of the set value and measure the time until the Unit operates.  
**Operating Time**  
Adjust the slide resistor so that the voltage applied to the K8AK terminals is 120% of the set value (for overvoltage detection) and 80% of the set value (for undervoltage detection) when the auxiliary relay operates, as shown in connection diagram 2. Close the switch and use the cycle counter to measure the operating time.

Connection Diagram 2

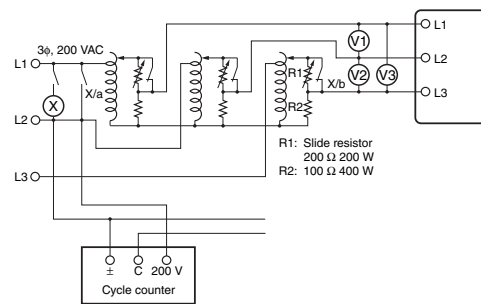

**Q** Checking the Phase Sequence and Phase Loss Operation

**A** **Phase Sequence**  
Switch the wiring, as shown by the dotted lines in connection diagram 1, to reverse the phase sequence and check that the K8AK operates.  
**Phase loss**  
Create a phase loss for any input phase and check that the K8AK operates.

K8AK-PM

Questions and Answers

**Q** Load-side Phase Loss

**A** In principle, phase loss cannot be detected on the load side because the K8AK-PM measures three-phase voltage to determine phase loss.

**Q** Motor Load Phase Loss during Operation

**A** Motor load phase loss cannot be detected during operation. It can be used to detect phase loss at startup. Normally, three-phase motors will continue to rotate even if one phase is open. The three-phase voltage will be induced at the motor terminals. The diagram shows voltage induction at the motor terminals when phase R has been lost with a load applied to a three-phase motor. The horizontal axis shows the motor load as a percentage of the rated load, and the vertical axis shows voltage as a percentage of the rated voltage. The lines in the graph show the voltage induced at the motor terminals for each load phase loss occurs during operation. As the graph shows, phase loss cannot be detected because the motor terminal voltage does not drop very much even if a phase is lost when the load on the motor is light. To detect motor load phase loss during operation, use the undervoltage detection function to detect the motor terminal voltages at phase loss. Set the operating time carefully because it will affect the time from when the phase loss occurs until tripping when this function is used.

**Q** Overvoltage Detection When Only One Phase Exceeds the Overvoltage Set Value

**A** The K8AK monitors each of the three-phase voltages. This means an overvoltage is detected even if only one phase exceeds the set value. The same applies to undervoltages.

Characteristic Curve Diagram

**Note:** This characteristic curve shows the approximate values only.

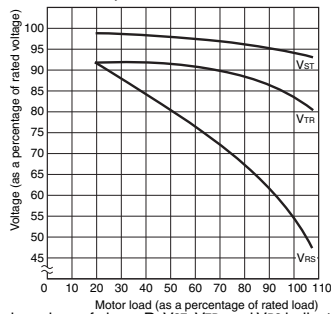

**Note:** For phase loss of phase R, V<sup>st</sup>, V<sup>tr</sup>, and V<sup>rs</sup> indicate the motor terminal voltage at phase loss.

# Three-phase Asymmetry and Phase-sequence Phase-loss Relay K8AK-PA

**Ideal for 3-phase voltage asymmetry monitoring for industrial facilities and equipment.**

- Greater resistance to inverter noise. *NEW*
- Monitor voltage asymmetry, phase sequence, and phase loss for three-phase 3-wire or 4-wire power supplies with just one Unit.  
Switch setting for 3-phase 3-wire or 3-phase 4-wire power supply.
- One SPDT output relay, 5 A at 250 VAC (resistive load).
- World-wide power specifications supported by one Unit (switchable).
- Relay status can be monitored using LED indicator.
- RoHS-compliant.



For the most recent information on models that have been certified for safety standards, refer to your OMRON website.

⚠ Refer to *Safety Precautions for the K8AK Series* on page 86.  
Refer to page 73 for commonly asked questions.

### Single K8AK Monitors 3-phase Power Supply with 3 or 4 Wires

Monitoring Relays can be used to monitor 3-phase power supplies with 3 or 4 wires simply by changing DIP switch settings.

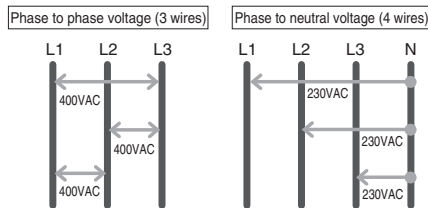

**A Single K8AK Can Monitor a 3-phase Power Supply Anywhere in the World**

Reduces Maintenance Parts Inventory

	SW3		ON	ON	OFF	OFF	
	SW4		ON	OFF	ON	OFF	
K8AK-PA1	SW2	ON	P-N	138 V	133 V	127 V	115 V
		OFF	P-P	240V	230 V	220 V	200 V
K8AK-PA2	SW2	ON	P-N	277 V	240 V	230 V	220 V
		OFF	P-P	480 V	415 V	400 V	380 V

## K8AK-PA

### Ordering Information

#### List of Models

Rated input*		Model
3-phase 3-wire mode	200, 220, 230, 240 VAC	K8AK-PA1
3-phase 4-wire mode	115, 127, 133, 138 VAC	
3-phase 3-wire mode	380, 400, 415, 480 VAC	K8AK-PA2
3-phase 4-wire mode	220, 230, 240, 277 VAC	

**Note:** Three-phase, three-wire or four-wire and the input range are switched using a DIP switch.

\* The power supply voltage is the same as the rated input voltage.

### Ratings and Specifications

#### Ratings

Rated input voltage	K8AK-PA1	Three-phase, three-wire Mode: 200, 220, 230 and 240 VAC Three-phase, four-wire Mode: 115, 127, 133 and 138 VAC
	K8AK-PA2	Three-phase, three-wire Mode: 380, 400, 415 and 480 VAC Three-phase, four-wire Mode: 220, 230, 240 and 277 VAC
Input load	K8AK-PA1: Approx. 4.4 VA K8AK-PA2: Approx. 4.4 VA	
Operating value setting range (ASY.)	Asymmetry set value: 2% to 22%	
Operating value	Asymmetry operating value = Rated input voltage × Asymmetry set value (%) The asymmetry operation will function when the potential difference between the highest and lowest voltage phases equals or exceeds the asymmetry operating value.	
Reset value setting range (HYS.)	5% of operating value (fixed)	
Reset method	Automatic reset	
Operating time setting range (T)	Asymmetry	0.1 to 30 s
	Reversed phase/phase loss	0.1 s
Startup lock time (LOCK)	1 s/5 s (Changed with the DIP switch.)	
Indicators	Power (PWR): Green, Relay output (RY): Yellow, Alarm outputs (ALM): Red	
Output relays	One SPDT relay (NC operation)	
Output relay ratings	Rated load Resistive load 5 A at 250 VAC 5 A at 30 VDC Maximum contact voltage: 250 VAC or 30 VDC Max. switching current: 5 A Maximum switching capacity: 1,250 VA, 150 W Mechanical life: 10 million operations min. Electrical life: 5 A at 250 VAC or 30 VDC: 50,000 operations 3 A at 250 VAC/30 VDC: 100,000 operations	
Ambient operating temperature	-20 to 60°C (with no condensation or icing)	
Storage temperature	-25 to 65°C (with no condensation or icing)	
Ambient operating humidity	25% to 85% (with no condensation)	
Storage humidity	25% to 85% (with no condensation)	
Altitude	2,000 m max.	
Terminal screw tightening torque	0.49 N·m	
Terminal wiring method	Recommended wire Solid wire: 2.5 mm <sup>2</sup> Twisted wires: AWG16, AWG18 <b>Note:</b> 1. Ferrules with insulating sleeves must be used with twisted wires. 2. Two wires can be twisted together. Recommended ferrules Al 1,5-8BK (for AWG16) manufactured by Phoenix Contact Al 1-8RD (for AWG18) manufactured by Phoenix Contact Al 0,75-8GY (for AWG18) manufactured by Phoenix Contact	
Case color	N1.5	
Case material	PC and ABS	
Weight	Approx. 130 g	
Mounting	Mounts to DIN Track.	
Dimensions	22.5 × 90 × 100 mm (W×H×D)	

K8AK-PA

Specifications

<b>Input frequency</b>	50/60 Hz	
<b>Overload capacity</b>	Continuous input at 115% of maximum input, 10 s at 125% (up to 600 VAC).	
<b>Repeat accuracy</b>	<b>Operating value</b>	±0.5% full scale (at 25°C and 65% humidity, rated power supply voltage, 50/60 Hz sine wave input)
	<b>Operating time</b>	±50 ms (at 25°C and 65% humidity, rated power supply voltage)
<b>Applicable standards</b>	<b>Conforming standards</b>	EN60947-5-1 Installation environment (pollution level 2, installation category III)
	<b>EMC</b>	EN60947-5-1
	<b>Safety standards</b>	UL 508 (Recognition), Korean Radio Waves Act (Act 10564), CSA: CAN/CSA C22.2 No.14, CCC: GB14048.5
<b>Insulation resistance</b>	20 MΩ min. Between external terminals and case Between input terminals and output terminals	
<b>Dielectric strength</b>	2,000 VAC for one minute Between external terminals and case Between input terminals and output terminals	
<b>Noise immunity</b>	1,500 V power supply terminal common/normal mode Square-wave noise of ±1 μs/100 ns pulse width with 1-ns rise time	
<b>Vibration resistance</b>	Frequency: 10 to 55 Hz, acceleration 50 m/s <sup>2</sup> 10 sweeps of 5 min each in X, Y, and Z directions	
<b>Shock resistance</b>	150 m/s <sup>2</sup> , 3 times each in 6 directions along 3 axes However, 100 m/s <sup>2</sup> for relay contacts.	
<b>Degree of protection</b>	Terminals: IP20	

● Relationship of Mounting Distance between K8AK-PA Relays and Ambient Temperature (Reference Values)

The following diagram shows the relationship between the mounting distances and the ambient temperature.

If the relay is used with an ambient temperature that exceeds these values, the temperature of the K8AK may rise and shorten the life of the internal components.

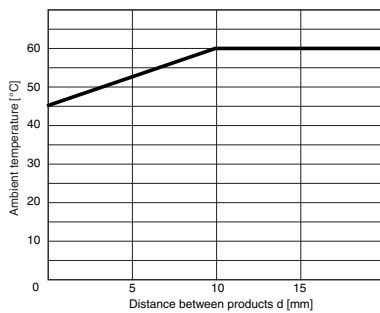

Test method

Sample: K8AK-PA

Mounting distances: 0, 5, and 10 mm min.

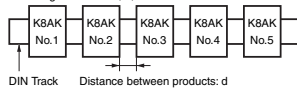

**K8AK-PA**

**Connections**

**Wiring Diagram**

**●Voltage Asymmetry and Phase Sequence/Phase Loss Operation Diagram**

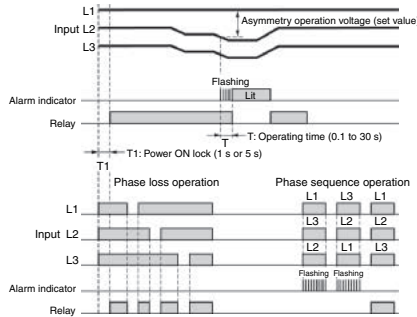

- Note:**
1. K8AK-PA output relay is normally operative.
  2. The power ON lock prevents unnecessary alarms from being generated during the instable period when the power is first turned on. There is no relay output during timer operation.
  3. Phase loss is detected by L1, L2, and L3 voltage drops. A phase loss will exist if any of the phases drops below 60% of the rated input. If the voltage drops dramatically, then the Relay will not operate due to an undervoltage.
  4. L1 and L2 function both as the power supply terminals and as input terminals.
  5. Motor load phase loss cannot be detected during operation.
  6. Phase loss is detected based on voltage, so phase loss cannot be detected on the load side.

**Calculating the Asymmetry Operating Voltage**  
 Asymmetry operation condition = (Highest voltage - Lowest voltage) > Asymmetry operating voltage  
 Asymmetry operating voltage = Rated input voltage (V) × Asymmetry set value (%)  
**Note:** The rated input voltage is selected and set with the DIP switch.

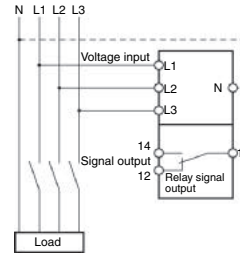

**Operation Indicators**

Item	Display		Contact operation
	Ry indicator	Alarm indicator	Alarm relay
Asymmetry	OFF	ON	OFF
Phase loss	OFF	ON	OFF
Reversed phase	OFF	Flashing*	OFF
Correct phase	ON	OFF	ON

\* The indicator will flash once per second after a phase loss is detected and once per 0.5 second during the detection time.

**Nomenclature**

**Front**

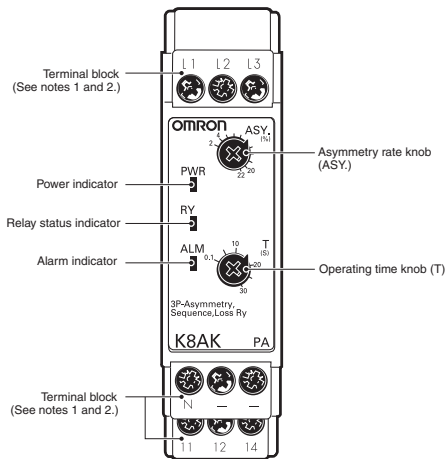

**●Indicators**

Item	Meaning
Power indicator (PWR: Green)	Lit when power is being supplied*
Relay status indicator (RY: Yellow)	Lit when relay is operating (normally lit).
Alarm indicator (ALM: Red)	Asymmetry voltage error indicator The indicator flashes to indicate the error status after the input has exceeded the set value while the operating time is being clocked.

\* The input across L1 and L2 is used for the internal power supply. Therefore, the power indicator will not be lit if there is no input across L1 and L2.

**●Setting Knobs**

Item	Usage
Asymmetry rate knob (ASY)	Used to set the asymmetry rate to 2% to 22%.
Operating time knob (T)	Used to set the operating time to 0.1 to 30 s.

**Note: 1.** Use either a solid wire of 2.5 mm<sup>2</sup> maximum or a ferrule with insulating sleeve for the terminal connection. The length of the exposed current-carrying part inserted into the terminal must be 8 mm or less to maintain dielectric strength after connection.

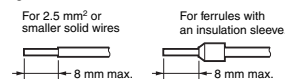

**Recommended ferrules**  
Phoenix Contact

- Al 1,5-8BK (for AWG16)
- Al 1-8RD (for AWG18)
- Al 0,75-8GY (for AWG18)

**2.** Screw tightening torque: 0.49 N·m max.

### K8AK-PA

#### Operation and Setting Methods

##### ●Connections

- Input**  
Connect to L1, L2, and L3 (for three-phase three-wire mode) or L1, L2, L3, and N (for three-phase four-wire mode), depending on the mode selected using pin 2 on the DIP switch.  
The Unit will not operate correctly if the DIP switch setting and the wiring do not agree.  
Make sure the phase sequence is wired correctly. The Unit will not operate normally if the phase sequence is incorrect.
- Outputs**  
Terminals 11, 12, and 14 are output terminals for SPDT.  
\* Use the recommended ferrules if you use twisted wires.

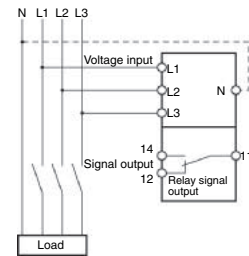

##### ●DIP Switch Settings

The power ON lock time, number of wires, and rated voltage are set using the DIP switch located on the bottom of the Unit.

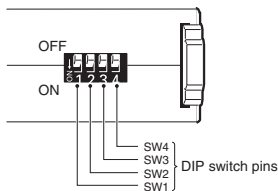

#### DIP Switch Functions

##### K8AK-PA1

Pin		OFF ● ↑			
		1	2	3	4
		ON ○ ↓			
Power ON lock time	1 s	●	---	---	---
	5 s	○	---	---	---
Number of wires	3-wire 3-phase	---	●	---	---
	4-wire 3-phase	---	○	---	---
Rated voltage	3-wire 3-phase				
	4-wire 3-phase				
	200 V	115 V	---	---	●
	220 V	127 V	---	---	○
	230 V	133 V	---	---	●
240 V	138 V	---	---	○	

Note: All pins are set to OFF at the factory.

##### K8AK-PA2

Pin		OFF ● ↑			
		1	2	3	4
		ON ○ ↓			
Power ON lock time	1 s	●	---	---	---
	5 s	○	---	---	---
Number of wires	3-wire 3-phase	---	●	---	---
	4-wire 3-phase	---	○	---	---
Rated voltage	3-wire 3-phase				
	4-wire 3-phase				
	380 V	220 V	---	---	●
	400 V	230 V	---	---	○
	415 V	240 V	---	---	●
480 V	277 V	---	---	○	

Note: All pins are set to OFF at the factory.



**K8AK-PA**

**●Setting Method**

1. Asymmetry  
 Asymmetry is set using the asymmetry operation knob (ASY.)  
 The setting range can be between 2% and 22% of the rated input.  
 Turn the knob while there is an input to the input terminals until the alarm indicator flashes (when the set value and the input have reached the same level.)  
 Use this as a guide to set the asymmetry.  
 The rated input depends on the model and DIP switch setting.  
 Example: K8AK-PA1 with Pin 2 Turned OFF (Three-phase, Three-wire Mode) and Pins 3 and 4 Turned OFF (Rated Voltage of 200 V)  
 The rated input voltage is 200 VAC and the setting range is 4 to 44 V.  
 If the setting (ASY. knob) is at 10%, the asymmetry operation voltage is 20 V and an alarm will be output if the difference between the minimum and maximum phases for two of the three phases exceeds 20 V.
2. Operating Time  
 The operating time is set using the operating time knob (T).  
 The operating time can be set to between 0.1 and 30 s.  
 Turn the knob while there is an input to the input terminals until the alarm indicator flashes (when the set value and the input have reached the same level.)  
 Use this as a guide to set the operating time.  
 If the input exceeds the asymmetry set value, the alarm indicator will start flashing for the set period and then stay lit.

**Dimensions**

(Unit: mm)

**Three-phase Asymmetry and Phase-sequence Phase-loss Relay**

K8AK-PA1  
K8AK-PA2

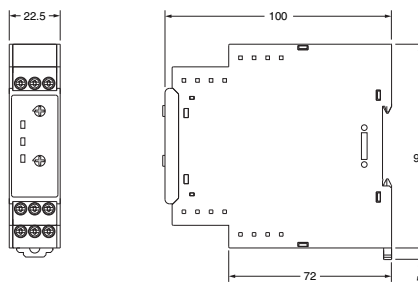

**Optional Parts for DIN Track Mounting**

**●DIN Tracks**  
 PFP-100N  
 PFP-50N

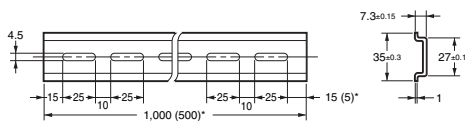
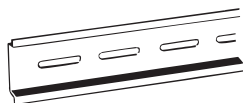

\*Dimensions in parentheses are for the PFP-50N.

K8AK-PA

Questions and Answers

**Q** Checking Operation

**A** With the rated input voltage applied, gradually change the voltage to any one phase. The Unit will operate when the difference between the maximum and minimum voltage phases reaches or exceeds the asymmetry operating value. Asymmetry operating value = Rated input voltage × Asymmetry set value (%)

Example: For monitoring mode set to three-phase three-wire monitoring, a rated voltage of 200 V, and an operating time of 5 s.

Note: K8AK-PA□ output relays are normally operative.

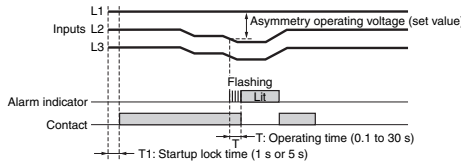

Connection Diagram 1

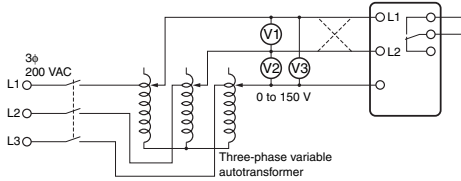

**Q** How to Measure the Operating Time

**A** Operating Time  
Adjust the slide resistor so that the voltage difference applied to the K8AK terminals is equal to or greater than the asymmetry operating value when the auxiliary relay operates, as shown in connection diagram 2. Close the switch and use the cycle counter to measure the operating time.

Connection Diagram 2

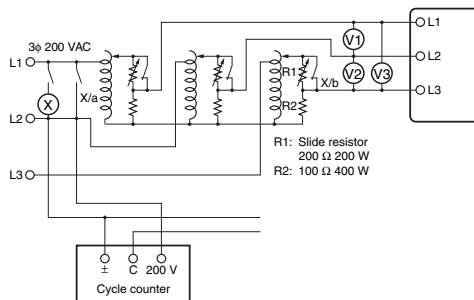

**Q** Checking the Phase Sequence and Phase Loss Operation

**A** Phase Sequence Operation  
Switch the wiring, as shown by the dotted lines in connection diagram 1, to reverse the phase sequence and check that the K8AK operates.  
Phase Loss Operation  
Create a phase loss for any input phase and check that the K8AK operates.

**Q** Load-side Phase Loss

**A** In principle, phase loss cannot be detected on the load side because the K8AK-PA□ measures three-phase voltage to determine phase loss.

**Q** Motor Load Phase Loss during Operation

**A** Phase loss cannot be detected for motor loads during operation. Use the asymmetry detection function. Normally, three-phase motors will continue to rotate even if one phase is open. The three-phase voltage will be induced at the motor terminals. The diagram shows voltage induction at the motor terminals when phase R is lost with a load applied to a three-phase motor. The horizontal axis shows the motor load as a percentage of the rated load, and the vertical axis shows voltage as a percentage of the rated voltage. The lines in the graph show the voltage induced at the motor terminals for each load when phase loss occurs during operation. As the graph shows, phase loss cannot be detected because the motor terminal voltage does not drop very much even if a phase is lost when the load on the motor is light. Use the asymmetry detection function to detect asymmetry in the motor terminal voltages. Set the operating time carefully because it will affect the time from when the phase loss occurs until tripping when this function is used.

Characteristic Curve Diagram

Note: This characteristic curve shows the approximate values only.

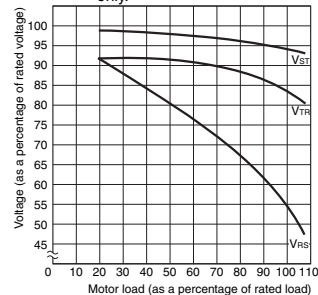

Note: For phase loss of phase R, V<sup>St</sup>, V<sup>Tr</sup>, and V<sup>RS</sup> indicate the motor terminal voltage at phase loss.

# Temperature Monitoring Relay **K8AK-TH**

## Compact and Slim Relay Ideal for Temperature Alarms and Monitoring

- Excessive temperature increases can be prevented and abnormal temperatures can be monitored.
- Temperature monitoring in slim design with a width of just 22.5 mm.
- Rotary switches simplifies temperature settings.
- Universal-input support for thermocouple or platinum resistance thermometer sensor input.
- Change the output relay between normally open and normally closed operation.
- Alarm status identification with LED indicator.
- Self-holding output.
- RoHS-compliant.

Refer to *Safety Precautions for the K8AK Series* on page 86.



For the most recent information on models that have been certified for safety standards, refer to your OMRON website.

## Ordering Information

### K8AK-TH (Temperature Input Models)

Power supply	Type	Output relays	Input types	Setting units (setting range)	Model
100 to 240 VAC	Temperature input	1 relay	Thermocouple or platinum resistance thermometer	Setting unit: 1°C or 1°F (0 to 999°C/°F)	K8AK-TH11S 100-240VAC
			Thermocouple	Setting unit: 10°C/°F*	K8AK-TH12S 100-240VAC
24 VAC/DC			Thermocouple or platinum resistance thermometer	Setting unit: 1°C or 1°F (0 to 999°C/°F)	K8AK-TH11S 24VAC/DC
			Thermocouple	Setting unit: 10°C/°F*	K8AK-TH12S 24VAC/DC

\* Refer to *Setting Ranges* on page 76 for the setting ranges.

**Note:** When ordering, designate the power supply specification. Different Relay models are used for 100 to 240 VAC and 24 VAC/VDC.

K8AK-TH

Specifications

Ratings

Item	Power supply voltage	100 to 240 VAC 50/60 Hz	24 VAC 50/60 Hz or 24 VDC
Allowable voltage range		85% to 110% of power supply voltage	
Power consumption		5 VA max.	2 W max. (24 VDC), 4 VA max. (24 VAC)
Sensor inputs	K8AK-TH11S	Thermocouple: K, J, T, E; Platinum-resistance thermometer: Pt100, Pt1000	
	K8AK-TH12S	Thermocouple: K, J, T, E, B, R, S, PLII	
Output relay		One SPDT relay (5 A at 250 VAC, resistive load)	
External inputs (for latch setting)	Contact input	ON: 1 kΩ max., OFF: 100 kΩ min.	
	Non-contact input	ON residual voltage: 1.5 V max., OFF leakage current: 0.1 mA max.	
		Leakage current: Approx. 10 mA	
Setting method		Rotary switch setting (set of three switches)	
Indicators		Power (PWR): Green LED, Relay output (ALM): Red LED	
Other functions		Alarm Mode (upper limit/lower limit), non-fail safe/fail safe selection, output latch, setting protection, temperature unit °C/°F	
Ambient operating temperature		-20 to 55°C (with no condensation or icing)	
Ambient operating humidity		Relative humidity: 25% to 85%	
Storage temperature		-25 to 65°C (with no condensation or icing)	

Characteristics

Measurement accuracy	±1% of the setting range		
hysteresis width	2°C		
Output relay	1 SPDT relay output 5 A at 250 VAC or 30 VDC (resistive load) Electrical life: 50,000 operations 3 A at 250 VAC or 30 VDC (resistive load) Electrical life: 100,000 operations		
Sampling cycle	100 ms		
Insulation resistance	20 MΩ (at 500 V) between charged terminals and exposed uncharged parts 20 MΩ (at 500 V) between any charged terminals (i.e., between input, output, and power supply terminals) 20 MΩ (at 500 V) between contacts (open)		
Dielectric strength	2,300 VAC, 50/60 Hz for 1 min between terminals of different charge		
Vibration resistance	Vibration of 10 to 55 Hz and acceleration of 50 m/s <sup>2</sup> for 5 min with 10 sweeps each in X, Y, and Z directions		
Shock resistance	150 m/s <sup>2</sup> (100 m/s <sup>2</sup> for relay contacts) 3 times each in 6 directions in X, Y, and Z directions		
Weight	Approx. 160 g		
Degree of protection	IP20		
Memory protection	Non-volatile memory (number of writes: 1 million)		
Safety Standards	Approved standards	UL 61010-1 Installation environment (pollution level 2, installation category II)	
	EMC	EN 61326-1	
	Application standards	UL 61010-1, Korean Radio Waves Act (Act 10564), CSA: CAN/CSA C22.2 No.14, CCC: GB14048.5	
Terminal screw tightening torque	0.49 N·m		
Crimp terminals	Two solid wires of 2.5 mm <sup>2</sup> or two ferrules of 1.5 mm <sup>2</sup> with insulation sleeves can be tightened together.		
Case color	N1.5		
Case material	PC and ABS		
Mounting	Mounts to DIN Track.		
Dimensions	22.5 × 100 × 90 mm (W × D × H)		

**K8AK-TH**

**Setting Ranges**

●K8AK-TH11S

Centigrade

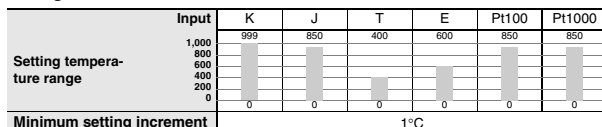

Minimum setting increment 1°C

Fahrenheit

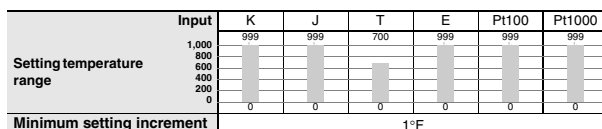

Minimum setting increment 1°F

●K8AK-TH12S

Centigrade

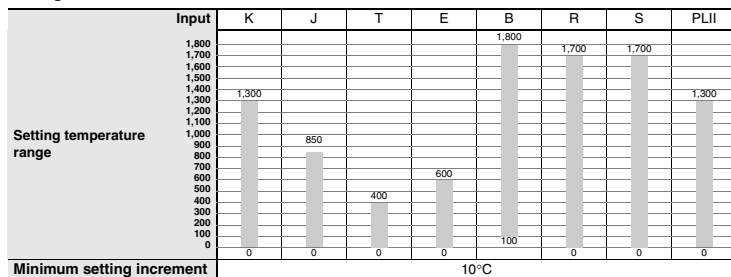

Minimum setting increment 10°C

Fahrenheit

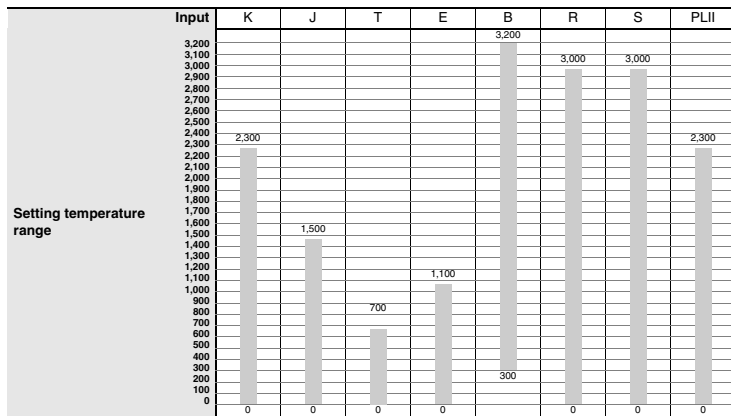

Minimum setting increment 10°F

●Temperature Input Range

TH11S Input type	°C		°F	
	Lower limit	Upper limit	Lower limit	Upper limit
K	-20	1019	-40	1039
J	-20	870	-40	1039
T	-20	420	-40	740
E	-20	620	-40	1039
Pt100	-20	870	-40	1039
Pt1000	-20	870	-40	1039
---	---	---	---	---
---	---	---	---	---

TH12S Input type	°C		°F	
	Lower limit	Upper limit	Lower limit	Upper limit
K	-20	1320	-40	2340
J	-20	870	-40	1540
T	-20	420	-40	740
E	-20	620	-40	1140
B	0	1820	0	3240
R	-20	1720	-40	3040
S	-20	1720	-40	3040
PLII	-20	1320	-40	2340

**K8AK-TH**

**Connections**

**Wiring Diagrams**

**K8AK-TH11S**

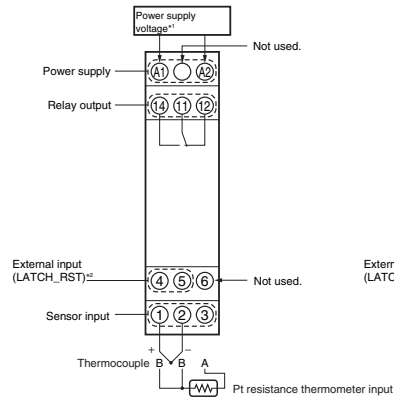

**K8AK-TH12S**

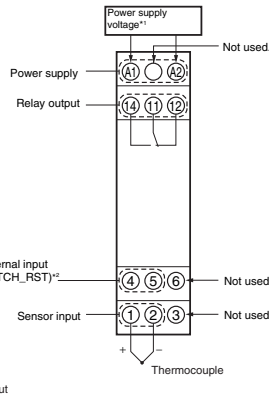

\*1 The input power supply depends on the model: 100 to 240 VAC or 24 VAC/VDC (no polarity)

\*2 Wiring of the external input terminals is as shown below.



**Timing Charts**

■ Temperature Alarm: Hysteresis: 2°C/°F

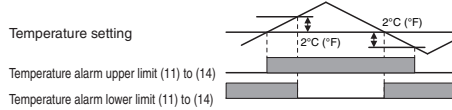

■ Changing between Normally Open and Normally Closed

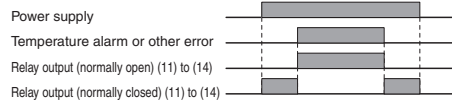

\* Other errors: sensor open circuit error, sensor input error, temperature setting error, and memory error.

■ Latched Operation: Relay outputs remain latched even after the alarm or error is reset.

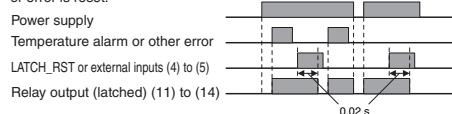

\* To enter SV Protect Mode or reset the latch, turn ON the LATCH\_RST signal or external input for at least 5 seconds.

■ Operation of Indicators

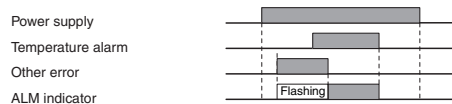
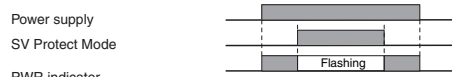

**K8AK-TH**

**Nomenclature**

**Front Operations**

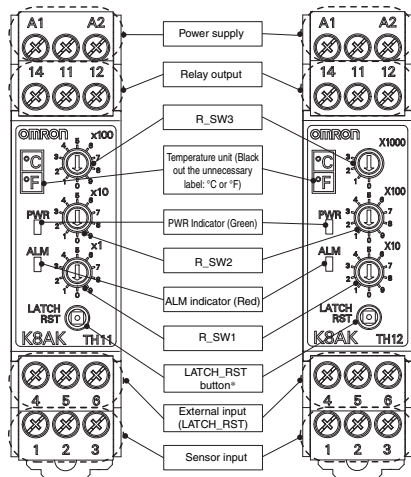

●**Error (ALM indicator: Flashing)**

One of the following items 1 to 3 has occurred.

1. The sensor circuit is disconnected or the temperature setting is out of the specified range.
2. The temperature setting is out of the specified range.
3. There is a problem in the internal circuits.

**Corrections**

1. Disable SV Protect Mode.
2. Disable the latch.
3. Check for incorrect wiring, circuit disconnections, short circuits, and whether the input type and temperature settings are correct.
4. If the wiring and settings are correct, reset the power supply.

If the Unit resumes normal operation, the problem may have been caused by noise.

If the Unit does not resume normal operation, it must be replaced.

\* The non-volatile memory stores the event when a latched output is disabled, or the SV Protect Mode is enabled or disabled. An error may occur if the data is updated more than one million times.

\* If you press and hold the LATCH\_RST button for 5 seconds or longer, the SV Protect Mode will go into effect. When SV Protect Mode is enabled, the PWR indicator flashes. To disable the SV Protect Mode, press and hold the LATCH\_RST Button for at least 5 seconds.

●**Alarm Setting Rotary Switch**



Point the arrow to the required number.

**Note: 1.** Use solid-core wires of 2.5-mm<sup>2</sup> max. or ferrules with an insulation sleeve to wire to this terminal. To ensure the dielectric strength of the connection, do not expose more than 8 mm of wire for insertion into the terminal.

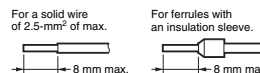

**Recommended Ferrules**

- Phoenix Contact  
 AI 1.5-8BK (for AWG16)  
 •AI 1-8RD (for AWG18)  
 •AI 0.75-8GY (for AWG18)

2. Screw tightening torque: 0.49 N·m

### K8AK-TH

#### Function Selection DIP Switch

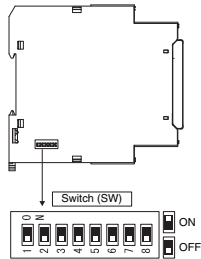

\* Default settings: All OFF

Turn OFF the power to the Temperature Monitoring Relay before you change the switch settings on the side panel. The switch settings made on the side panel take effect when the power is turned ON. Use a precision screwdriver to manipulate the switches and button.

#### Settings

K8AK-TH11S

R_SW3	100°C/°F units (0 to 9)
R_SW2	10°C/°F units (0 to 9)
R_SW1	1°C/°F units (0 to 9)

\* Default: 0°C

	SW						
	1	2	3	4	5	6	7
Upper limit alarm	<input type="checkbox"/>	<input type="checkbox"/>	<input type="checkbox"/>	<input type="checkbox"/>	<input type="checkbox"/>	<input type="checkbox"/>	<input type="checkbox"/>
Lower limit alarm	<input type="checkbox"/>	<input type="checkbox"/>	<input type="checkbox"/>	<input type="checkbox"/>	<input type="checkbox"/>	<input type="checkbox"/>	<input type="checkbox"/>
With latching	<input type="checkbox"/>	<input type="checkbox"/>	<input type="checkbox"/>	<input type="checkbox"/>	<input type="checkbox"/>	<input type="checkbox"/>	<input type="checkbox"/>
Without latching	<input type="checkbox"/>	<input type="checkbox"/>	<input type="checkbox"/>	<input type="checkbox"/>	<input type="checkbox"/>	<input type="checkbox"/>	<input type="checkbox"/>
Energized	<input type="checkbox"/>	<input type="checkbox"/>	<input type="checkbox"/>	<input type="checkbox"/>	<input type="checkbox"/>	<input type="checkbox"/>	<input type="checkbox"/>
Non-energized	<input type="checkbox"/>	<input type="checkbox"/>	<input type="checkbox"/>	<input type="checkbox"/>	<input type="checkbox"/>	<input type="checkbox"/>	<input type="checkbox"/>
-C	<input type="checkbox"/>	<input type="checkbox"/>	<input type="checkbox"/>	<input type="checkbox"/>	<input type="checkbox"/>	<input type="checkbox"/>	<input type="checkbox"/>
°F	<input type="checkbox"/>	<input type="checkbox"/>	<input type="checkbox"/>	<input type="checkbox"/>	<input type="checkbox"/>	<input type="checkbox"/>	<input type="checkbox"/>
					Pt1000	<input type="checkbox"/>	<input type="checkbox"/>
					Not used.	<input type="checkbox"/>	<input type="checkbox"/>
					Not used.	<input type="checkbox"/>	<input type="checkbox"/>

\* Default: All OFF.  
\* SW8: Not used.

K8AK-TH12S

R_SW3	1,000°C/°F units (0 to 3) * A temperature setting error occurs if this switch is set to a value from 4 to 9.
R_SW2	100°C/°F units (0 to 9)
R_SW1	10°C/°F units (0 to 9)

\* Default: 0°C

	SW						
	1	2	3	4	5	6	7
Upper limit alarm	<input type="checkbox"/>	<input type="checkbox"/>	<input type="checkbox"/>	<input type="checkbox"/>	<input type="checkbox"/>	<input type="checkbox"/>	<input type="checkbox"/>
Lower limit alarm	<input type="checkbox"/>	<input type="checkbox"/>	<input type="checkbox"/>	<input type="checkbox"/>	<input type="checkbox"/>	<input type="checkbox"/>	<input type="checkbox"/>
With latching	<input type="checkbox"/>	<input type="checkbox"/>	<input type="checkbox"/>	<input type="checkbox"/>	<input type="checkbox"/>	<input type="checkbox"/>	<input type="checkbox"/>
Without latching	<input type="checkbox"/>	<input type="checkbox"/>	<input type="checkbox"/>	<input type="checkbox"/>	<input type="checkbox"/>	<input type="checkbox"/>	<input type="checkbox"/>
Energized	<input type="checkbox"/>	<input type="checkbox"/>	<input type="checkbox"/>	<input type="checkbox"/>	<input type="checkbox"/>	<input type="checkbox"/>	<input type="checkbox"/>
Non-energized	<input type="checkbox"/>	<input type="checkbox"/>	<input type="checkbox"/>	<input type="checkbox"/>	<input type="checkbox"/>	<input type="checkbox"/>	<input type="checkbox"/>
-C	<input type="checkbox"/>	<input type="checkbox"/>	<input type="checkbox"/>	<input type="checkbox"/>	<input type="checkbox"/>	<input type="checkbox"/>	<input type="checkbox"/>
°F	<input type="checkbox"/>	<input type="checkbox"/>	<input type="checkbox"/>	<input type="checkbox"/>	<input type="checkbox"/>	<input type="checkbox"/>	<input type="checkbox"/>
					K	<input type="checkbox"/>	<input type="checkbox"/>
					J	<input type="checkbox"/>	<input type="checkbox"/>
					T	<input type="checkbox"/>	<input type="checkbox"/>
					E	<input type="checkbox"/>	<input type="checkbox"/>
					B	<input type="checkbox"/>	<input type="checkbox"/>
					R	<input type="checkbox"/>	<input type="checkbox"/>
					S	<input type="checkbox"/>	<input type="checkbox"/>
					PLII	<input type="checkbox"/>	<input type="checkbox"/>

\* Default: All OFF.  
\* SW8: Not used.

Safety standards	EN 61010-1
EMC	EMI EN 61326-1
	EMS EN 61326-1



**K8AK-TH**

**Functions**

● **SV Protection**

This function protects (i.e., prohibits changing) the alarm setting, operating method, and modes for the Temperature Monitoring Relay that have been set on the rotary switches and DIP switch.

The protection function is activated by pressing the output latch reset button on the Temperature Monitoring Relay for at least 5 s or by turning ON the input to the external input terminal for at least 5 s.

The power indicator will flash when the protection is activated.

The protection function can be released by pressing the output latch reset button on the Temperature Monitoring Relay for at least 5 s or by turning ON the input to the external input terminal for at least 5 s.

The power indicator will light while the protection is being reset.

**Dimensions**

(Unit: mm)

**Note:** All units are in millimeters unless otherwise indicated.

**Temperature Monitoring Relay**

**K8AK-TH**

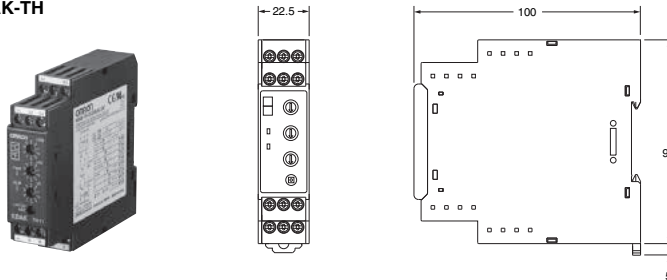

**Track Mounting Products (Sold Separately)**

**Mounting Track**

**PFP-100N**  
**PFP-50N**

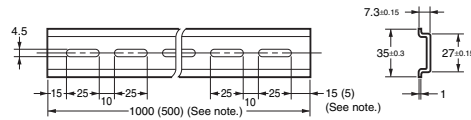
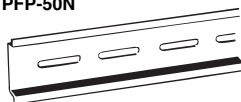

\* Dimensions in parentheses are for the PFP-50N.

## Conductive Level Controller K8AK-LS

**Ideal for liquid level control in industrial facilities and equipment.**

- Self-holding ON or OFF outputs can be selected using self-holding circuit.
- Sensitivity adjustment of operating resistance from 10 to 100 kΩ for application to a wide range of liquids.
- Prevents chattering of relay contacts that occurs with ripples.
- Easy wiring with ferrules.
- Use 2 × 2.5 mm<sup>2</sup> solid wire or 2 × 1.5 mm<sup>2</sup> ferrules.
- Applicable as a floatless switch.
- RoHS-compliant.



For the most recent information on models that have been certified for safety standards, refer to your OMRON website.

Refer to *Safety Precautions for the K8AK Series* on page 86.

### Ordering Information

Power supply voltage	Model
24 VAC/DC	K8AK-LS1 24 VAC/DC
100 to 240 VAC	K8AK-LS1 100-240 VAC

### Accessories (Order Separately)

#### ●Electrode Holders/Underwater Electrodes

Application	For general-purpose use, such as water supply lines	For areas with limited space	For liquids with low resistance	When mounting strength is required	For resistance to high-temperature or high-pressure liquids	For resistance against corrosion	For installation at long distances from the liquid level
Model	PS-3S/-4S/-5S (2-wire models are also available)	PS-31 SUS304, 300 mm	BF-1	BF-3/-5	BS-1	BS-1T	PH-1/-2
Appearance							

#### ●Electrode Rods

Electrode Rods are available in sets with the connection nuts, lock nuts, and tightening screws.



Application	Purified water service, industrial water, and sewage	Purified water service, industrial water, sewage, and weak alkaline solutions
Model	F03-60 SUS304	F03-60 SUS316

#### ●Others

Item	Model
Protective Cover (Electrode Holders for the PS or BF Series)	F03-11
Mounting Piece (Electrode Holder for the PS Series)	F03-12
Separator (to prevent contact between electrodes)	F03-14 1P (one pole) F03-14 3P (three poles) F03-14 5P (five poles)

## K8AK-LS

### Ratings and Specifications

#### Ratings

<b>Rated voltage</b>	24 VAC 50/60 Hz or 24 VDC 100 to 240 VAC 50/60 Hz
<b>Voltage across electrodes</b>	5 V p-p (Approx. 20 Hz)
<b>Power consumption</b>	24 VAC/DC: 2.0 VA/1.1 W max. 100 to 240 VAC: 4.6 VA max.
<b>Operating resistance</b>	10 to 100 kΩ (variable)
<b>Reset resistance</b>	250 kΩ max.
<b>Response time</b>	Approx. 0.1 to 10 s (variable)
<b>Length of cable</b>	100 m max. (fully insulated 3-core 0.75-mm <sup>2</sup> cable, 600 V)
<b>Indicators</b>	PWR: Green, RY: Yellow
<b>Output contact ratings</b>	Rated load Resistive load 5 A at 250 VAC 5 A at 30 VDC Maximum contact voltage: 250 VAC or 30 VDC Max. switching current: 5 A Maximum switching capacity: 1,250 VA, 150 W Mechanical life: 10 million operations min. Electrical life: 5 A at 250 VAC or 30 VDC: 50,000 operations 3 A at 250 VAC/30 VDC: 100,000 operations
<b>Ambient operating temperature</b>	-20 to 60°C (with no condensation or icing)
<b>Storage temperature</b>	-25 to 65°C (with no condensation or icing)
<b>Ambient humidity</b>	25% to 85% (with no condensation)
<b>Storage humidity</b>	25% to 85% (with no condensation)
<b>Altitude</b>	2,000 m max.
<b>Terminal screw tightening torque</b>	0.49 N·m
<b>Case color</b>	N1.5
<b>Case material</b>	PC and ABS
<b>Weight</b>	Approx. 150 g
<b>Mounting</b>	Mounts to DIN Track.
<b>Dimensions</b>	22.5 × 90 × 100 mm (W×D×H)

#### Specifications

<b>Operating voltage range</b>	85% to 110% of rated voltage
<b>Installation environment</b>	Installation category II, pollution level 2
<b>Approved standards</b>	EN61010-1
<b>EMC</b>	EN61326-1
<b>Safety standards</b>	EN 60664-1, UL 508 (Recognition), Korean Radio Waves Act (Act 10564), CSA: CAN/CSA C22.2 No. 14, CCC: GB14048.5
<b>Insulation resistance</b>	20 MΩ min. Between all external terminals and the case Between all power supply terminals and all input terminals Between all power supply terminals and all output terminals Between all input terminals and all output terminals
<b>Dielectric strength</b>	2,000 VAC for 1 min Between all external terminals and the case Between all power supply terminals and all input terminals Between all power supply terminals and all output terminals Between all input terminals and all output terminals
<b>Noise immunity</b>	1,500 V power supply terminal common/normal mode Square-wave noise of ±1-μs/100-ns pulse width with 1-ns rise time
<b>Vibration resistance</b>	Frequency: 10 to 55 Hz, acceleration 50 m/s <sup>2</sup> 10 sweeps of 5 min each in X, Y, and Z directions
<b>Shock resistance</b>	150 m/s <sup>2</sup> , 3 times each in 6 directions along 3 axes However, 100 m/s <sup>2</sup> for relay contacts.
<b>Degree of protection</b>	Terminals: IP20

#### Connections

##### Operation Diagram

##### ● Operation Timing Chart (DIP Switch Pin 1: OFF (Automatic Liquid Supply Operation))

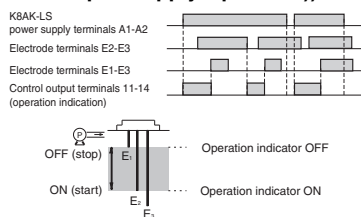

- When the liquid level falls to E2 (indicator turns ON), the pump starts.  
When the liquid level rises above E1 (indicator turns OFF), the pump stops.

##### ● Operation Timing Chart (DIP Switch Pin 1: ON (Automatic Liquid Discharge Operation))

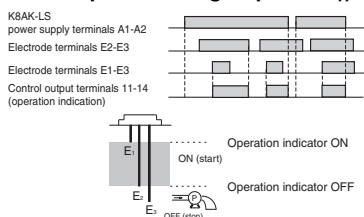

- When the liquid level reaches E1 (indicator turns ON), the pump starts.  
When the liquid level falls below E2 (indicator turns OFF), the pump stops.

##### Wiring Diagram

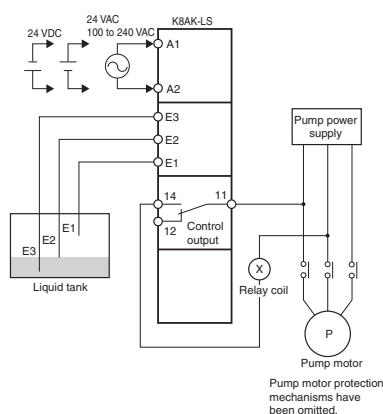

## K8AK-LS

### Nomenclature

#### Front Panel

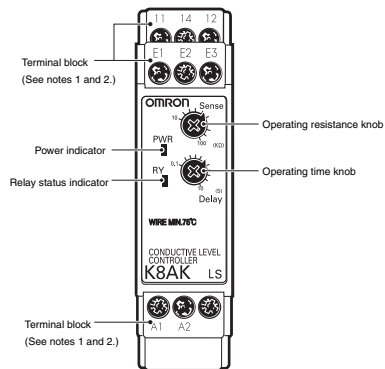

#### ●Indicators

Item	Description
Power indicator (PWR: Green)	Lit when power is being supplied.
Relay status indicator (RY: Yellow)	Lit when contacts are operating.

#### ●Setting Knobs

Item	Description
Operating resistance knob	Used to set the resistance to 10 to 100 kΩ.
Operating time knob	Used to set the operating time to 0.1 to 10 s.

**Note 1.** Use solid-core wires of 2.5-mm<sup>2</sup> max. or ferrules with an insulation sleeve to wire to this terminal. To ensure the dielectric strength of the connection, do not expose more than 8 mm of wire for insertion into the terminal.

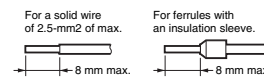

#### Recommended ferrules

- Phoenix Contact
- Al 1,5-8BK (for AWG16)
- Al 1-8RD (for AWG18)
- Al 0,75-8GY (for AWG18)

2. Screw tightening torque: 0.49 N·m max.

### Operating and Setting Procedures

#### ●Wiring

Wire the terminals as shown in the following figure. Use terminals 11 and 14 in both liquid supply mode and liquid drain mode.

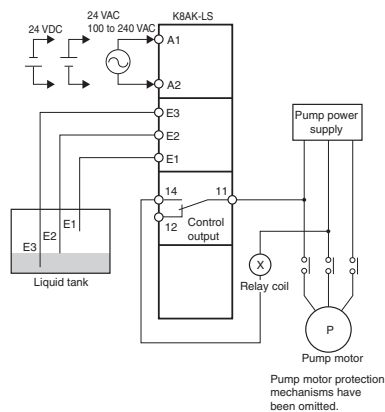

#### ●DIP Switch Settings

The operating mode is set using the DIP switch located at the bottom of the Unit. The K8AK-LS does not have SW2.

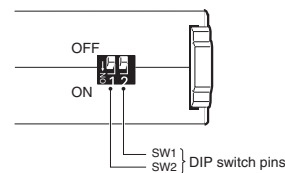

#### DIP Switch Function

Pin	OFF ● / ON ○	OFF 1	2
Operating mode	Automatic liquid supply operation (●) / Automatic liquid discharge operation (○)	● / ○	Not used.

**Note:** All pins are set to OFF by default.

# Datenblatt

## Spannungsüberwachungsrelais K8DS-PM

K8DS-PM



### K8AK-LS

#### Dimensions

(Unit: mm)

K8AK-LS

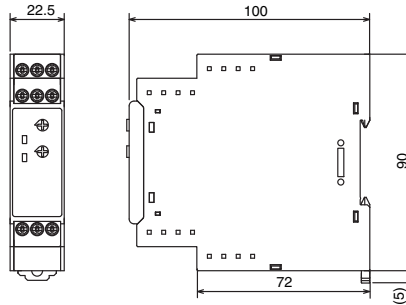

#### Optional Parts for DIN Track Mounting

##### ●DIN Tracks

PFP-100N

PFP-50N

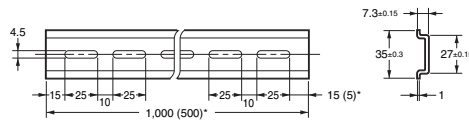
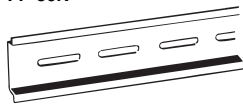

\*Dimensions in parentheses are for the PFP-50N.

## Safety Precautions

Be sure to read the precautions for all models in the website at the following URL: <http://www.ia.omron.com/>.

### Warning Indications

	<b>CAUTION</b> Indicates a potentially hazardous situation which, if not avoided, may result in minor or moderate injury or in property damage.
<b>Precautions for Safe Use</b>	Supplementary comments on what to do or avoid doing, to use the product safely.
<b>Precautions for Correct Use</b>	Supplementary comments on what to do or avoid doing, to prevent failure to operate, malfunction, or undesirable effects on product performance.

If the K8AK-TH fails, the monitoring alarms and alarm outputs may fail to operate. This may result in physical damage to the facilities, equipment, or other devices that are connected to it. To reduce this risk, inspect the product regularly. To make the product fail-safe, take alternative safety measures, such as the installation of monitoring devices on a separate circuit.



Use of the product beyond its life may result in contact welding or burning. Make sure to consider the actual operating conditions and use the product within its rated load and electrical life count. The life of the output relay varies significantly with the switching capacity and switching conditions.



### Meaning of Product Safety Symbols

	Used to warn of the risk of electric shock under specific conditions.
	Used for general prohibitions for which there is no specific symbol.
	Used to indicate prohibition when there is a risk of minor injury from electrical shock or other source if the product is disassembled.
	Used for general mandatory action precautions for which there is no specified symbol.

### CAUTION

Electrical shock may cause minor injury.  
Do not touch terminals while electricity is being supplied.



There is a risk of minor electrical shock, fire, or device failure.  
Do not allow any pieces of metal, conductors, or cutting chips that occur during the installation process to enter the product.



Explosions may cause minor injuries. Do not use the product in locations with inflammable or explosive gases.



There is a risk of minor electrical shock, fire, or device failure.  
Do not disassemble, modify, repair, or touch the inside of the product.



Loose screws may cause fires. Tighten terminal screws to the specified torque of 0.49 to 0.59 N·m.



Use of excessive torque may damage the terminal screws.  
Tighten terminal screws to the specified torque of 0.49 to 0.59 N·m.



If the setting does not match the element to be monitored, the product may behave unexpectedly and damage the machine or cause accidents. Set the K8AK-TH as described below.



- Adjust each set value on the K8AK-TH correctly for the element that is to be monitored.
- Turn OFF the power to the K8AK-TH before you change the switch settings on the side panel. The switch settings made on the side panel take effect when the power is turned ON.

### Precautions for Safe Use

- Do not use or store the product in the following locations.
  - Locations subject to water or oil
  - Locations subject to direct radiant heat from heating equipment
  - Outdoor locations or under direct sunlight
  - Locations subject to dust or corrosive gases (particularly sulfurizing gases, ammonia, etc.)
  - Locations subject to rapid temperature changes
  - Locations prone to icing and dew condensation
  - Locations subject to excessive vibration or shock
  - Locations subject to wind and rain
  - Locations subject to static electricity and noise
  - Habitats of insects or small animals
- Use and store the product in a location where the ambient temperature and humidity are within the specified ranges. If applicable, provide forced cooling.
- Mount the product in the correct direction.
- Check terminal polarity when wiring and wire all connections correctly. The power supply terminals do not have polarity.
- Do not wire the input and output terminals incorrectly.
- Make sure the power supply voltage and loads are within the specifications and ratings for the product.
- Make sure the type of the thermocouple matches the input type that the K8AK-TH is designed for.
- If you need to extend the length of the lead wires on the thermocouple to use with the K8AK-TH, make sure to match the type of thermocouple and always use compensating conductors.
- To extend the lead wires on the platinum resistance thermometer that is used with the K8AK-TH, use lead wires with a low resistance (5 Ω or less per wire), and make the resistance equal on all three lead wires.
- Make sure the crimp terminals for wiring are of the specified size.
- Do not connect anything to terminals that are not being used.
- Use a power supply that will reach the rated voltage within 1 second after the power is turned ON.
- After you turn ON the power, it takes 2 seconds for the outputs of the K8AK-TH to stabilize. Take this time into account when you design the control panel.
- Allow at least 30 minutes for the K8AK-TH to warm up. During this time, the temperature measurements will be incorrect.
- Keep wiring separate from high voltages and power lines that draw large currents.  
Do not place product wiring in parallel with or in the same path as high-voltage or high-current lines.
- Do not install the product near equipment that generates high frequencies or surges.
- The product may cause incoming radio wave interference. Do not use the product near radio wave receivers.
- Install an external switch or circuit breaker and label it clearly so that the operator can quickly turn OFF the power supply.

19. When cleaning the product, do not use thinners or solvents. Use commercial alcohol.
20. Make sure the power and output indicators operate correctly. Depending on the application environment, the indicators and other plastic parts may wear prematurely and become difficult to see. Check and replace these parts regularly.
21. The terminal blocks may heat up to 65°C. Use care when handling them.
22. Do not use the product if it is accidentally dropped. The internal components may be damaged.
23. Be sure you understand the contents of this catalog and handle the product according to the instructions provided.
24. Do not install the product in any way that would place a load on it.
25. When discarding the product, properly dispose of it as industrial waste.
26. When using the product, remember that the power supply terminals carry a high voltage.
27. The product must be handled only by trained electrician.
28. Prior to operation, check the wiring before you supply power to the product.
29. Do not install the product immediately next to heat sources.

#### Precautions for Correct Use

#### Observe the following operating methods to prevent failure and malfunction.

1. Use operating power, input power, and other power supplies and converters with suitable capacities and rated outputs.
2. Allow only qualified personnel to manage or handle the product.
3. Use a precision screwdriver or similar tool to adjust the setting knobs.
4. The distortion in the input waveform for the K8AK-AS, K8AK-AW, K8AK-PH, K8AK-PA, K8AK-PM, or K8DS-PH must be 30% max. If the input waveform is distorted beyond this level, it may cause unnecessary operation.  
Do not use the K8AK-VS or K8AK-VW in circuits with waveform distortion. Error will be large due to waveform distortion.
5. Error will be large if the K8AK-AS, K8AK-AW, K8AK-VS, or K8AK-VW is used for thyristor or inverter control.  
The K8AK-PH, K8AK-PA, K8AK-PM, K8AK-PW, or K8DS-PH cannot be used on the secondary side of an inverter. To use the product on the load side of an inverter, install a noise filter on the primary side of the inverter.
6. To reduce the error in the setting knob, always turn the setting knob from the minimum setting toward the maximum setting.
7. Phase loss is detected for the K8AK-PA or K8AK-PM only when the phase loss occurs between the input contacts and the power supply. Phase loss is not detected on the load side.
8. Phase loss can be detected only from the input contacts to the power supply side by the K8AK-PH, K8AK-PA, K8AK-PM, or K8DS-PH. Phase loss cannot be detected from the input contacts to the load side.

#### Mounting and Removing the K8AK

- Mounting to DIN Track
  1. Catch the upper hook on the DIN Track.
  2. Push the product onto the Track until the hooks lock into place.

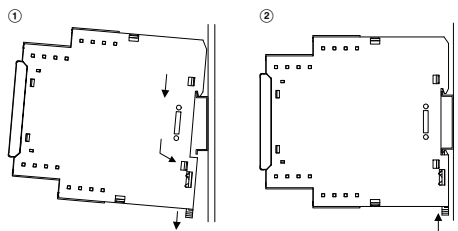

- To remove the product, pull down on the bottom hook with a flat-blade screwdriver and lift up on the product.

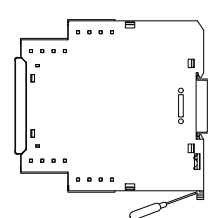

Applicable DIN Tracks:  
PFP-100N (100 cm)  
PFP-50N (50 cm)

#### Mounting and Removing the K8DS

- The product may be mounted in any direction, but it must be mounted securely and as level as possible.
- To mount the product to the DIN Track, hook it on the DIN Track at (A) and then press in on the Unit in direction (B).

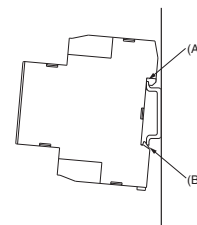

- To remove the product, insert a flat-blade screwdriver at (C) and pull down the hook to release the Unit.

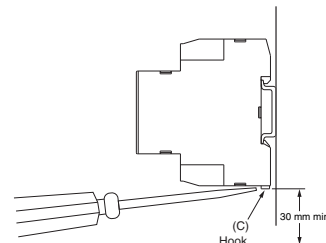

- Leave at least 30 mm of space between the product and other devices to allow easy installation and removal.

#### Adjusting the Setting Knobs

- Use a screwdriver to adjust the setting knobs. The knobs have a stopper that prevents them from turning beyond the full right or left position. Do not force a knob beyond these points.

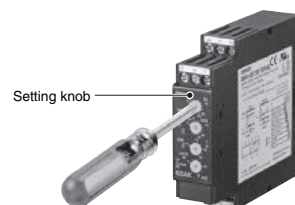

\* (Not applicable to the K8AK-PH and K8DS-PH.)

#### Read and Understand This Catalog

Please read and understand this catalog before purchasing the products. Please consult your OMRON representative if you have any questions or comments.

#### Warranty and Limitations of Liability

##### WARRANTY

OMRON's exclusive warranty is that the products are free from defects in materials and workmanship for a period of one year (or other period if specified) from date of sale by OMRON.

OMRON MAKES NO WARRANTY OR REPRESENTATION, EXPRESS OR IMPLIED, REGARDING NON-INFRINGEMENT, MERCHANTABILITY, OR FITNESS FOR PARTICULAR PURPOSE OF THE PRODUCTS. ANY BUYER OR USER ACKNOWLEDGES THAT THE BUYER OR USER ALONE HAS DETERMINED THAT THE PRODUCTS WILL SUITABLY MEET THE REQUIREMENTS OF THEIR INTENDED USE. OMRON DISCLAIMS ALL OTHER WARRANTIES, EXPRESS OR IMPLIED.

##### LIMITATIONS OF LIABILITY

OMRON SHALL NOT BE RESPONSIBLE FOR SPECIAL, INDIRECT, OR CONSEQUENTIAL DAMAGES, LOSS OF PROFITS OR COMMERCIAL LOSS IN ANY WAY CONNECTED WITH THE PRODUCTS, WHETHER SUCH CLAIM IS BASED ON CONTRACT, WARRANTY, NEGLIGENCE, OR STRICT LIABILITY.

In no event shall the responsibility of OMRON for any act exceed the individual price of the product on which liability is asserted.

IN NO EVENT SHALL OMRON BE RESPONSIBLE FOR WARRANTY, REPAIR, OR OTHER CLAIMS REGARDING THE PRODUCTS UNLESS OMRON'S ANALYSIS CONFIRMS THAT THE PRODUCTS WERE PROPERLY HANDLED, STORED, INSTALLED, AND MAINTAINED AND NOT SUBJECT TO CONTAMINATION, ABUSE, MISUSE, OR INAPPROPRIATE MODIFICATION OR REPAIR.

#### Application Considerations

##### SUITABILITY FOR USE

OMRON shall not be responsible for conformity with any standards, codes, or regulations that apply to the combination of products in the customer's application or use of the products.

At the customer's request, OMRON will provide applicable third party certification documents identifying ratings and limitations of use that apply to the products. This information by itself is not sufficient for a complete determination of the suitability of the products in combination with the end product, machine, system, or other application or use.

The following are some examples of applications for which particular attention must be given. This is not intended to be an exhaustive list of all possible uses of the products, nor is it intended to imply that the uses listed may be suitable for the products:

- Outdoor use, uses involving potential chemical contamination or electrical interference, or conditions or uses not described in this catalog.
- Nuclear energy control systems, combustion systems, railroad systems, aviation systems, medical equipment, amusement machines, vehicles, safety equipment, and installations subject to separate industry or government regulations.
- Systems, machines, and equipment that could present a risk to life or property.

Please know and observe all prohibitions of use applicable to the products.

NEVER USE THE PRODUCTS FOR AN APPLICATION INVOLVING SERIOUS RISK TO LIFE OR PROPERTY WITHOUT ENSURING THAT THE SYSTEM AS A WHOLE HAS BEEN DESIGNED TO ADDRESS THE RISKS, AND THAT THE OMRON PRODUCTS ARE PROPERLY RATED AND INSTALLED FOR THE INTENDED USE WITHIN THE OVERALL EQUIPMENT OR SYSTEM.

##### PROGRAMMABLE PRODUCTS

OMRON shall not be responsible for the user's programming of a programmable product, or any consequence thereof.

#### Disclaimers

##### CHANGE IN SPECIFICATIONS

Product specifications and accessories may be changed at any time based on improvements and other reasons.

It is our practice to change model numbers when published ratings or features are changed, or when significant construction changes are made. However, some specifications of the products may be changed without any notice. When in doubt, special model numbers may be assigned to fix or establish key specifications for your application on your request. Please consult with your OMRON representative at any time to confirm actual specifications of purchased products.

##### DIMENSIONS AND WEIGHTS

Dimensions and weights are nominal and are not to be used for manufacturing purposes, even when tolerances are shown.

##### PERFORMANCE DATA

Performance data given in this catalog is provided as a guide for the user in determining suitability and does not constitute a warranty. It may represent the result of OMRON's test conditions, and the users must correlate it to actual application requirements. Actual performance is subject to the OMRON Warranty and Limitations of Liability.

##### ERRORS AND OMISSIONS

The information in this document has been carefully checked and is believed to be accurate; however, no responsibility is assumed for clerical, typographical, or proofreading errors, or omissions.



---

## Datenblatt

### Spannungsüberwachungsrelais K8DS-PM

K8DS-PM



**ALL DIMENSIONS SHOWN ARE IN MILLIMETERS.**

To convert millimeters into inches, multiply by 0.03937. To convert grams into ounces, multiply by 0.03527.

Cat. No. N172-E2-03-X

**In the interest of product improvement, specifications are subject to change without notice.**

---

#### **OMRON EUROPE B.V.**

Wegalaan 67-69,  
NL-2132 JD, Hoofddorp,  
The Netherlands  
Phone: +31 23 568 13 00  
Fax: +31 23 568 13 88  
industrial.omron.eu