

## Digital Temperature Controllers Programmable Type

User's Manual

E5□C-T



1  
Introduction

2  
Preparations

3  
Part Names and  
Basic Procedures

4  
Basic  
Operation

5  
Advanced  
Operations

6  
Parameters

7  
User Calibration

A  
Appendices

I  
Index



# Preface

---

Thank you for purchasing an E5□C-T Digital Controller.

This manual describes how to use the E5□C-T. Read this manual thoroughly and be sure you understand it before attempting to use the Digital Controller and use the Digital Controller correctly according to the information provided. Keep this manual in a safe place for easy reference. Refer to the *E5□C-T Digital Controllers Programmable Type Communications Manual* (Cat. No. H186) for information on communications.

**© OMRON, 2014**

All rights reserved. No part of this publication may be reproduced, stored in a retrieval system or transmitted, in any form, or by any means, mechanical, electronic, photocopying, recording, or otherwise, without the prior written permission of OMRON.

No patent liability is assumed with respect to the use of the information contained herein. Moreover, because OMRON is constantly striving to improve its high-quality products, the information contained in this manual is subject to change without notice. Every precaution has been taken in the preparation of this manual. Nevertheless, OMRON assumes no responsibility for errors or omissions. Neither is any liability assumed for damages resulting from the use of the information contained in this publication.

# Terms and Conditions Agreement

---

## Warranty, Limitations of Liability

### Warranties

---

- **Exclusive Warranty**

Omron's exclusive warranty is that the Products will be free from defects in materials and workmanship for a period of twelve months from the date of sale by Omron (or such other period expressed in writing by Omron). Omron disclaims all other warranties, express or implied.

- **Limitations**

OMRON MAKES NO WARRANTY OR REPRESENTATION, EXPRESS OR IMPLIED, ABOUT NON-INFRINGEMENT, MERCHANTABILITY OR FITNESS FOR A PARTICULAR PURPOSE OF THE PRODUCTS. BUYER ACKNOWLEDGES THAT IT ALONE HAS DETERMINED THAT THE PRODUCTS WILL SUITABLY MEET THE REQUIREMENTS OF THEIR INTENDED USE.

Omron further disclaims all warranties and responsibility of any type for claims or expenses based on infringement by the Products or otherwise of any intellectual property right.

- **Buyer Remedy**

Omron's sole obligation hereunder shall be, at Omron's election, to (i) replace (in the form originally shipped with Buyer responsible for labor charges for removal or replacement thereof) the non-complying Product, (ii) repair the non-complying Product, or (iii) repay or credit Buyer an amount equal to the purchase price of the non-complying Product; provided that in no event shall Omron be responsible for warranty, repair, indemnity or any other claims or expenses regarding the Products unless Omron's analysis confirms that the Products were properly handled, stored, installed and maintained and not subject to contamination, abuse, misuse or inappropriate modification. Return of any Products by Buyer must be approved in writing by Omron before shipment. Omron Companies shall not be liable for the suitability or unsuitability or the results from the use of Products in combination with any electrical or electronic components, circuits, system assemblies or any other materials or substances or environments. Any advice, recommendations or information given orally or in writing, are not to be construed as an amendment or addition to the above warranty.

See <http://www.omron.com/global/> or contact your Omron representative for published information.

### Limitation on Liability; Etc

---

OMRON COMPANIES SHALL NOT BE LIABLE FOR SPECIAL, INDIRECT, INCIDENTAL, OR CONSEQUENTIAL DAMAGES, LOSS OF PROFITS OR PRODUCTION OR COMMERCIAL LOSS IN ANY WAY CONNECTED WITH THE PRODUCTS, WHETHER SUCH CLAIM IS BASED IN CONTRACT, WARRANTY, NEGLIGENCE OR STRICT LIABILITY.

Further, in no event shall liability of Omron Companies exceed the individual price of the Product on which liability is asserted.



## Application Considerations

### Suitability of Use

---

Omron Companies shall not be responsible for conformity with any standards, codes or regulations which apply to the combination of the Product in the Buyer's application or use of the Product. At Buyer's request, Omron will provide applicable third party certification documents identifying ratings and limitations of use which apply to the Product. This information by itself is not sufficient for a complete determination of the suitability of the Product in combination with the end product, machine, system, or other application or use. Buyer shall be solely responsible for determining appropriateness of the particular Product with respect to Buyer's application, product or system. Buyer shall take application responsibility in all cases.

NEVER USE THE PRODUCT FOR AN APPLICATION INVOLVING SERIOUS RISK TO LIFE OR PROPERTY WITHOUT ENSURING THAT THE SYSTEM AS A WHOLE HAS BEEN DESIGNED TO ADDRESS THE RISKS, AND THAT THE OMRON PRODUCT(S) IS PROPERLY RATED AND INSTALLED FOR THE INTENDED USE WITHIN THE OVERALL EQUIPMENT OR SYSTEM.

### Programmable Products

---

Omron Companies shall not be responsible for the user's programming of a programmable Product, or any consequence thereof.

## Disclaimers

### Performance Data

---

Data presented in Omron Company websites, catalogs and other materials is provided as a guide for the user in determining suitability and does not constitute a warranty. It may represent the result of Omron's test conditions, and the user must correlate it to actual application requirements. Actual performance is subject to the Omron's Warranty and Limitations of Liability.

### Change in Specifications

---

Product specifications and accessories may be changed at any time based on improvements and other reasons. It is our practice to change part numbers when published ratings or features are changed, or when significant construction changes are made. However, some specifications of the Product may be changed without any notice. When in doubt, special part numbers may be assigned to fix or establish key specifications for your application. Please consult with your Omron's representative at any time to confirm actual specifications of purchased Product.

### Errors and Omissions

---

Information presented by Omron Companies has been checked and is believed to be accurate; however, no responsibility is assumed for clerical, typographical or proofreading errors or omissions.

# Safety Precautions

## Definition of Precautionary Information





The following notation is used in this manual to provide precautions required to ensure safe usage of the E5□C-T Digital Controllers.

The safety precautions that are provided are extremely important to safety. Always read and heed the information provided in all safety precautions.

The following notation is used.

 <b>CAUTION</b>	Indicates a potentially hazardous situation which, if not avoided, may result in minor or moderate injury or in property damage.
<b>Precautions for Safe Use</b>	Supplementary comments on what to do or avoid doing, to use the product safely.
<b>Precautions for Correct Use</b>	Supplementary comments on what to do or avoid doing, to prevent failure to operate, malfunction or undesirable effect on product performance.

## Symbols

Symbol		Meaning
Caution		<ul style="list-style-type: none"> <li>General Caution Indicates non-specific general cautions, warnings, and dangers.</li> </ul>
		<ul style="list-style-type: none"> <li>Electrical Shock Caution Indicates possibility of electric shock under specific conditions.</li> </ul>
Prohibition		<ul style="list-style-type: none"> <li>General Prohibition Indicates non-specific general prohibitions.</li> </ul>
		<ul style="list-style-type: none"> <li>Disassembly Prohibition Indicates prohibitions when there is a possibility of injury, such as from electric shock, as the result of disassembly.</li> </ul>
Mandatory Caution		<ul style="list-style-type: none"> <li>General Caution Indicates non-specific general cautions, warnings, and dangers.</li> </ul>

● Safety Precautions

 **CAUTION**

Minor injury due to electric shock may occasionally occur.  
Do not touch the terminals while power is being supplied.



Electric shock, fire, or malfunction may occasionally occur.  
Do not allow metal objects, conductors, cuttings from installation work, or moisture to enter the Digital Controller or a Setup Tool port. Attach the cover to the front-panel Setup Tool port whenever you are not using it to prevent foreign objects from entering the port.



Minor injury from explosion may occasionally occur.  
Do not use the product where subject to flammable or explosive gas.



Fire may occasionally occur.  
Do not allow dirt or other foreign objects to enter a Setup Tool port, or between the pins on the connectors on the Setup Tool cable.



Minor electric shock, fire, or malfunction may occasionally occur.  
Never disassemble, modify, or repair the product or touch any of the internal parts.



**CAUTION - Risk of Fire and Electric Shock**

- (a) This product is UL listed as Open Type Process Control Equipment. It must be mounted in an enclosure that does not allow fire to escape externally.
- (b) More than one disconnect switch may be required to de-energize the equipment before servicing.
- (c) Signal inputs are SELV, limited energy. <sup>\*1</sup>
- (d) Caution: To reduce the risk of fire or electric shock, do not interconnect the outputs of different Class 2 circuits. <sup>\*2</sup>



If the output relays are used past their life expectancy, contact fusing or burning may occasionally occur.

Always consider the application conditions and use the output relays within their rated load and electrical life expectancy. The life expectancy of output relays varies considerably with the output load and switching conditions.



<sup>\*1</sup> An SELV (separated extra-low voltage) system is one with a power supply that has double or reinforced insulation between the primary and the secondary circuits and has an output voltage of 30 V r.m.s. max. and 42.4 V peak max. or 60 VDC max.

<sup>\*2</sup> A class 2 circuit is one tested and certified by UL as having the current and voltage of the secondary output restricted to specific levels.

## CAUTION

---

Loose screws may occasionally result in fire.  
Tighten the terminal screws to the specified torque of 0.43 to 0.58 N·m.



---

Set the parameters of the product so that they are suitable for the system being controlled. If they are not suitable, unexpected operation may occasionally result in property damage or accidents.



---

A malfunction in the Digital Controller may occasionally make control operations impossible or prevent alarm outputs, resulting in property damage. To maintain safety in the event of malfunction of the Digital Controller, take appropriate safety measures, such as installing a monitoring device on a separate line.

---



# Precautions for Safe Use

---

Be sure to observe the following precautions to prevent operation failure, malfunction, or adverse affects on the performance and functions of the product. Not doing so may occasionally result in unexpected events. Do not handle the Digital Controller in ways that exceed the ratings.

- The product is designed for indoor use only. Do not use or store the product outdoors or in any of the following places.

Places directly subject to heat radiated from heating equipment.

Places subject to splashing liquid or oil atmosphere.

Places subject to direct sunlight.

Places subject to dust or corrosive gas (in particular, sulfide gas and ammonia gas).

Places subject to intense temperature change.

Places subject to icing and condensation.

Places subject to vibration and large shocks.

- Use and store the Digital Controller within the rated ambient temperature and humidity. Gang-mounting two or more Digital Controllers, or mounting Digital Controllers above each other may cause heat to build up inside the Digital Controllers, which will shorten their service life. In such a case, use forced cooling by fans or other means of air ventilation to cool down the Digital Controllers.
- To allow heat to escape, do not block the area around the Digital Controller. Do not block the ventilation holes on the Digital Controller.
- Be sure to wire properly with correct polarity of terminals.
- Use the specified size of crimped terminals (M3, width of 5.8 mm or less) for wiring. To connect bare wires to the terminal block, use copper braided or solid wires with a gage of AWG24 to AWG18 (equal to a cross-sectional area of 0.205 to 0.8231 mm<sup>2</sup>). (The stripping length is 6 to 8 mm.) Up to two wires of the same size and type, or two crimped terminals can be inserted into a single terminal.
- Do not wire the terminals that are not used.
- To avoid inductive noise, keep the wiring for the Digital Controller's terminal block away from power cables that carry high voltages or large currents. Also, do not wire power lines together with or parallel to Digital Controller wiring. Using shielded cables and using separate conduits or ducts is recommended.

Attach a surge suppressor or noise filter to peripheral devices that generate noise (in particular, motors, transformers, solenoids, magnetic coils or other equipment that have an inductance component).

When a noise filter is used at the power supply, first check the voltage or current, and attach the noise filter as close as possible to the Digital Controller.

Allow as much space as possible between the Digital Controller and devices that generate powerful high frequencies (high-frequency welders, high-frequency sewing machines, etc.) or surge.

- Use the Digital Controller within the rated load and power supply.
- Make sure that the rated voltage is attained within 2 seconds of turning ON the power using a switch or relay contact. If the voltage is applied gradually, the power may not be reset or output malfunctions may occur.
- Make sure that the Digital Controller has 30 minutes or more to warm up after turning ON the power before starting actual control operations to ensure the correct temperature display.
- A switch or circuit breaker must be provided close to Digital Controller. The switch or circuit breaker must be within easy reach of the operator, and must be marked as a disconnecting means for Digital Controller.
- Wipe off any dirt from the Digital Controller with a soft dry cloth. Never use thinners, benzene, alcohol, or any cleaners that contain these or other organic solvents. Deformation or discoloration may occur.

- Design the system (e.g., control panel) considering the 2 seconds of delay in setting the Digital Controller's output after the power supply is turned ON.
- The output will turn OFF when you move to the Initial Setting Level. Take this into consideration when performing control.
- The number of non-volatile memory write operations is limited. Therefore, use RAM write mode when frequently overwriting data, e.g., through communications.
- Use suitable tools when taking the Digital Controller apart for disposal. Sharp parts inside the Digital Controller may cause injury.
- Do not connect cables to both the front-panel Setup Tool port and the top-panel Setup Tool port at the same time.
- Do not exceed the communications distance that is given in the specifications and use the specified communications cable.
- Do not turn the power supply to the Digital Controller ON or OFF while the USB-Serial Conversion Cable is connected. The Digital Controller may malfunction.
- Do not bend the communications cables past their natural bending radius. Do not pull on the communications cables.

# Precautions for Correct Use

---

## ● Service Life

Use the Digital Controller within the following temperature and humidity ranges:

Temperature: –10 to 55°C (with no icing or condensation), Humidity: 25% to 85%

If the Digital Controller is installed inside a control board, the ambient temperature must be kept to under 55°C, including the temperature around the Controller.

The service life of electronic devices like Digital Controllers is determined not only by the number of times the relay is switched but also by the service life of internal electronic components. Component service life is affected by the ambient temperature: the higher the temperature, the shorter the service life and, the lower the temperature, the longer the service life. Therefore, the service life can be extended by lowering the temperature of the Digital Controller.

When two or more Digital Controllers are mounted horizontally close to each other or vertically next to one another, the internal temperature will increase due to heat radiated by the Digital Controllers and the service life will decrease. In such a case, use forced cooling by fans or other means of air ventilation to cool down the Digital Controllers. When providing forced cooling, however, be careful not to cool down the terminals sections alone to avoid measurement errors.

## ● Ensuring Measurement Accuracy

When extending or connecting the thermocouple lead wire, be sure to use compensating wires that match the thermocouple types.

When extending or connecting the lead wire of the platinum resistance thermometer, be sure to use wires that have low resistance and keep the resistance of the three lead wires the same.

Mount the Digital Controller so that it is horizontally level.

If the measurement accuracy is low, check to see if input shift has been set correctly.

## ● Resistance to Water

The degree of protection is as shown below. Sections without any specification on their degree of protection or those with IP□0 are not waterproof.

Front panel: IP66

Rear case: IP20, Terminal section: IP00

When waterproofing is required, insert the Waterproof Packing on the backside of the front panel. Keep the Port Cover on the front-panel Setup Tool port of the E5EC-T/E5AC-T securely closed. The degree of protection when the Waterproof Packing is used is IP66. To maintain an IP66 degree of protection, the Waterproof Packing and the Port Cover for the front-panel Setup Tool port must be periodically replaced because they may deteriorate, shrink, or harden depending on the operating environment. The replacement period will vary with the operating environment. Check the required period in the actual application. Use 3 years or sooner as a guideline. If the Waterproof Packing and Port Cover are not periodically replaced, waterproof performance may not be maintained. If a waterproof structure is not required, then the Waterproof Packing does not need to be installed.

# Precautions for Operation

---

- It takes approximately two seconds for the outputs to turn ON from after the power supply is turned ON. Design the system (e.g., control panel) to allow for this delay.
- The Digital Controller requires 30 minutes to warm up after the power supply is turned ON. Always turn ON the power supply at least 30 minutes before starting actual control operations.
- Avoid using the Digital Controller in places near a radio, television set, or wireless installing. The Digital Controller may cause radio disturbance for these devices.



# Preparations for Use

Be sure to thoroughly read and understand the manual provided with the product, and check the following points.

Timing	Check point	Details
Purchasing the product	Product appearance	After purchase, check that the product and packaging are not dented or otherwise damaged. Damaged internal parts may prevent optimum control.
	Product model and specifications	Make sure that the purchased product meets the required specifications.
Setting the Unit	Product installation location	Provide sufficient space around the product for heat dissipation. Do not block the vents on the product.
Wiring	Terminal wiring	Do not subject the terminal screws to excessive stress (force) when tightening them. Make sure that there are no loose screws after tightening terminal screws to the specified torque of 0.43 to 0.58 N·m.
		Be sure to confirm the polarity for each terminal before wiring the terminal block and connectors.
	Power supply inputs	Wire the power supply inputs correctly. Incorrect wiring will result in damage to the internal circuits.
Operating environment	Ambient temperature	The ambient operating temperature for the product is $-10$ to $55^{\circ}\text{C}$ (with no condensation or icing). To extend the service life of the product, install it in a location with an ambient temperature as low as possible. In locations exposed to high temperatures, if necessary, cool the products using a fan or other cooling method.
	Vibration and shock	Check whether the standards related to shock and vibration are satisfied at the installation environment. (Install the product in locations where the contactors will not be subject to vibration or shock.)
	Foreign particles	Install the product in a location that is not subject to liquid or foreign particles entering the product.

# Versions

Check the version on the nameplate on the E5□C-T Digital Controller or on the label on the packing box. If the version is not given, the version of the E5□C-T Digital Controller is version 1.0.

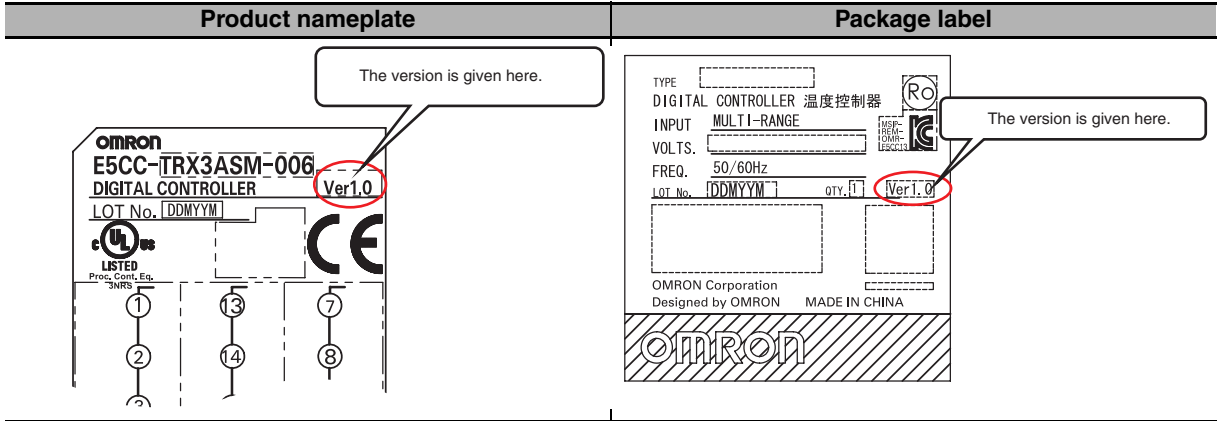

# Revision History

---

A manual revision code appears as a suffix to the catalog number on the front cover of the manual.

Cat. No.	<b>H185-E1-01</b>
----------	-------------------

↑  
Revision code

Revision code	Date	Revised content
01	January 2014	Original production

# Conventions Used in This Manual

## Model Notation

“E5□C-T” is used to indicate information that is the same for the E5CC-T, E5EC-T, and E5AC-T Digital Controllers. Also, “E5EC-TPR□,” “E5AC-TPR□,” or “Position-proportional Models” indicates the Digital Controllers with position-proportional control. “Standard Models” indicates other Digital Controllers.

## Meanings of Abbreviations

The following abbreviations are used in parameter names, figures, and other descriptions. These abbreviations mean the following:

Symbol	Term
PV	Process value
SP	Set point
SV	Set value
AT	Auto-tuning
EU	Engineering unit*
LBA	Loop burnout alarm
HB	Heater burnout
HS	Heater short
FSP	Fixed SP
PSP	Program SP

\* “EU” stands for Engineering Unit. EU is used as the minimum unit for engineering units such as °C, m, and g. The size of the EU depends on the input type. For example, when the input temperature setting range is –200 to 1,300°C, 1 EU is 1°C, and when the input temperature setting range is –20.0 to 500.0°C, 1 EU is 0.1°C. For analog inputs, the size of the EU depends on the decimal point position of the scaling setting, and 1 EU is the minimum scaling unit.

## How to Read Display Symbols

The following tables show the correspondence between the symbols displayed on the displays and alphabet characters.

<i>R</i>	<i>b</i>	<i>£</i>	<i>d</i>	<i>E</i>	<i>F</i>	<i>G</i>	<i>H</i>	<i>¯</i>	<i>J</i>	<i>K</i>	<i>L</i>	<i>M</i>
<b>A</b>	<b>B</b>	<b>C</b>	<b>D</b>	<b>E</b>	<b>F</b>	<b>G</b>	<b>H</b>	<b>I</b>	<b>J</b>	<b>K</b>	<b>L</b>	<b>M</b>

<i>N</i>	<i>ō</i>	<i>P</i>	<i>Q</i>	<i>R</i>	<i>S</i>	<i>t</i>	<i>U</i>	<i>v</i>	<i>W</i>	<i>x</i>	<i>Y</i>	<i>Z</i>
<b>N</b>	<b>O</b>	<b>P</b>	<b>Q</b>	<b>R</b>	<b>S</b>	<b>T</b>	<b>U</b>	<b>V</b>	<b>W</b>	<b>X</b>	<b>Y</b>	<b>Z</b>

## How This Manual is Organized

Goal	Related sections	Contents
<b>Learning about the appearance, features, functions, and model numbers</b>	<i>Section 1 Introduction</i>	---
<b>Setting up the E5□C-T</b>	<i>Section 2 Preparations</i>	This section describes the steps that are required before turning ON the power supply (including installation, terminal usage, wiring, and isolation/insulation block diagram). It also describes how to use the Setup Tool ports.
<b>Learning the basic procedures from turning ON the power supply to starting actual operation</b>	<i>Section 3 Part Names and Basic Procedures</i>	This section serves as a basic tutorial for first-time users of the E5□C.
<b>Learning the basic operating methods</b>	<i>Section 4 Basic Operation</i> <i>Section 6 Parameters</i>	These sections describe basic operating methods.
<b>Learning advanced operating methods</b>	<i>Section 5 Advanced Operations</i> <i>Section 6 Parameters</i>	These sections describe advanced operating methods.
<b>Calibrating the E5□C-T</b>	<i>Section 7 User Calibration</i>	This section describes the procedures that you can use to calibrate the sensor or transfer output of the E5□C-T.
<b>Learning the specifications and parameters of the E5□C-T</b>	<i>Appendices</i>	---

## Related Manuals

Also refer to the *E5□C-T Digital Controllers Communications Manual* (Cat. No. H186) for information on communications.



# Sections in this Manual

---

<b>1</b>	<b>Introduction</b>	<b>1</b>
<b>2</b>	<b>Preparations</b>	<b>2</b>
<b>3</b>	<b>Part Names and Basic Procedures</b>	<b>3</b>
<b>4</b>	<b>Basic Operation</b>	<b>4</b>
<b>5</b>	<b>Advanced Operations</b>	<b>5</b>
<b>6</b>	<b>Parameters</b>	<b>6</b>
<b>7</b>	<b>User Calibration</b>	<b>7</b>
<b>A</b>	<b>Appendices</b>	<b>A</b>
<b>I</b>	<b>Index</b>	<b>I</b>

# CONTENTS

---

<b>Preface</b> .....	<b>1</b>
<b>Terms and Conditions Agreement</b> .....	<b>2</b>
Warranty, Limitations of Liability .....	2
Application Considerations .....	3
Disclaimers .....	3
<b>Safety Precautions</b> .....	<b>4</b>
Definition of Precautionary Information .....	4
Symbols .....	4
<b>Precautions for Safe Use</b> .....	<b>7</b>
<b>Precautions for Correct Use</b> .....	<b>9</b>
<b>Precautions for Operation</b> .....	<b>10</b>
<b>Preparations for Use</b> .....	<b>11</b>
<b>Versions</b> .....	<b>12</b>
<b>Revision History</b> .....	<b>13</b>
<b>Conventions Used in This Manual</b> .....	<b>14</b>
Model Notation .....	14
Meanings of Abbreviations .....	14
How to Read Display Symbols .....	15
How This Manual is Organized .....	15
Related Manuals .....	15
<b>Sections in this Manual</b> .....	<b>17</b>

## Section 1 Introduction

---

<b>1-1 Appearance, Features, and Functions of the E5□C-T</b> .....	<b>1-2</b>
1-1-1 Appearance.....	1-2
1-1-2 Features .....	1-2
1-1-3 Main Functions.....	1-3
<b>1-2 I/O Configuration and Model Number Legend</b> .....	<b>1-5</b>
1-2-1 I/O Configuration.....	1-5
1-2-2 Model Number Legends.....	1-7

## Section 2 Preparations

---

<b>2-1 Installation</b> .....	<b>2-2</b>
2-1-1 Dimensions (Unit: mm).....	2-2
2-1-2 Panel Cutout (Unit: mm).....	2-3
2-1-3 Mounting .....	2-5
<b>2-2 Using the Terminals</b> .....	<b>2-7</b>
2-2-1 E5CC-T Terminal Block Wiring Example.....	2-7
2-2-2 E5EC-T/E5AC-T Terminal Block Wiring Example .....	2-11
2-2-3 Precautions when Wiring .....	2-16
2-2-4 Wiring.....	2-16



<b>2-3</b>	<b>Insulation Block Diagrams</b> .....	<b>2-23</b>
<b>2-4</b>	<b>Using the Setup Tool Port</b> .....	<b>2-24</b>
2-4-1	Procedure .....	2-24
2-4-2	Connection Method.....	2-24
2-4-3	Installing the Driver.....	2-27

## Section 3 Part Names and Basic Procedures

---

<b>3-1</b>	<b>Basic Application Flow</b> .....	<b>3-2</b>
<b>3-2</b>	<b>Power ON</b> .....	<b>3-3</b>
<b>3-3</b>	<b>Part Names, Part Functions, and Setting Levels</b> .....	<b>3-4</b>
3-3-1	Part Names and Functions .....	3-4
3-3-2	Entering Numeric Values .....	3-8
3-3-3	Setting Levels .....	3-9
<b>3-4</b>	<b>Procedures after Turning ON the Power Supply</b> .....	<b>3-14</b>
3-4-1	Basic Flow of Operations.....	3-14
3-4-2	Basic Procedure .....	3-15

## Section 4 Basic Operation

---

<b>4-1</b>	<b>Moving between Setting Levels</b> .....	<b>4-3</b>
4-1-1	Moving to the Initial Setting Level .....	4-3
4-1-2	Moving to the Program Setting Level.....	4-4
4-1-3	Moving to the Adjustment Level.....	4-5
4-1-4	Moving to the PID Setting Level.....	4-5
4-1-5	Moving to the Protect Level .....	4-6
4-1-6	Moving to the Advanced Function Setting Level.....	4-7
4-1-7	Moving to the Communications Setting Level.....	4-9
<b>4-2</b>	<b>Initial Setup Examples through Starting Program Operation</b> .....	<b>4-10</b>
4-2-1	Program Operation .....	4-10
4-2-2	Initial Setup Example for Step Time Programming .....	4-11
4-2-3	Initial Setup Example for Rate of Rise Programming.....	4-14
<b>4-3</b>	<b>Setting the Input Type</b> .....	<b>4-18</b>
4-3-1	Input Type .....	4-18
<b>4-4</b>	<b>Selecting the Temperature Unit</b> .....	<b>4-20</b>
4-4-1	Temperature Unit .....	4-20
<b>4-5</b>	<b>Selecting PID Control or ON/OFF Control (Not Supported for Position-proportional Models.)</b> .....	<b>4-21</b>
<b>4-6</b>	<b>Setting Output Specifications</b> .....	<b>4-22</b>
4-6-1	Control Periods (Not Supported for Position-proportional Models.).....	4-22
4-6-2	Direct and Reverse Operation .....	4-22
4-6-3	Assigned Output Functions (Assigning Control Outputs Is Not Supported for Position-proportional Models.).....	4-23
4-6-4	Auxiliary Output Opening or Closing in Alarm .....	4-26
<b>4-7</b>	<b>Setting Programs</b> .....	<b>4-27</b>
4-7-1	Programming .....	4-27
4-7-2	Program Patterns.....	4-30
4-7-3	Setting Flow for Program-related Settings .....	4-32
4-7-4	Making the Initial Program-related Settings.....	4-33
4-7-5	Creating the Program .....	4-39
4-7-6	Changing Programs during Operation .....	4-45
<b>4-8</b>	<b>Setting the Fixed SP</b> .....	<b>4-47</b>
4-8-1	Fixed SP Setting Methods .....	4-47

<b>4-9</b>	<b>Determining PID Constants (Autotuning and Manual Setting)</b> .....	<b>4-49</b>
4-9-1	AT (Auto-tuning) .....	4-50
4-9-2	RT (Robust Tuning) (Used for Autotuning) .....	4-52
4-9-3	Manual Setup .....	4-54
<b>4-10</b>	<b>Alarm Outputs</b> .....	<b>4-56</b>
4-10-1	Alarm Types .....	4-56
4-10-2	Alarm Values .....	4-59
<b>4-11</b>	<b>Alarm Hysteresis</b> .....	<b>4-62</b>
4-11-1	Standby Sequence.....	4-62
4-11-2	Alarm Latch.....	4-63
<b>4-12</b>	<b>Using Heater Burnout (HB) and Heater Short (HS) Alarms (Not Supported for Position-proportional Models.)</b> .....	<b>4-64</b>
4-12-1	HB Alarm.....	4-64
4-12-2	HS Alarm.....	4-66
4-12-3	Installing Current Transformers (CT).....	4-68
4-12-4	Calculating Detection Current Values .....	4-70
4-12-5	Application Examples.....	4-70
<b>4-13</b>	<b>Using ON/OFF Control (Not Supported for Position-proportional Models.)</b> .....	<b>4-74</b>
4-13-1	ON/OFF Control .....	4-74
4-13-2	Settings .....	4-75
<b>4-14</b>	<b>Customizing the PV/SP Display</b> .....	<b>4-76</b>
4-14-1	PV/SP Display Selections .....	4-76

## Section 5      **Advanced Operations**

---

<b>5-1</b>	<b>Shifting Input Values</b> .....	<b>5-3</b>
<b>5-2</b>	<b>Setting Scaling Upper and Lower Limits for Analog Inputs</b> .....	<b>5-5</b>
<b>5-3</b>	<b>Executing Heating/Cooling Control (Not Supported for Position-proportional Models.)</b> .	<b>5-7</b>
5-3-1	Heating/Cooling Control .....	5-7
<b>5-4</b>	<b>Using Event Inputs</b> .....	<b>5-11</b>
5-4-1	Event Input Settings .....	5-11
5-4-2	Using Event Inputs .....	5-11
<b>5-5</b>	<b>Setting the SP Upper and Lower Limit Values</b> .....	<b>5-16</b>
5-5-1	Set Point Limiter .....	5-16
5-5-2	Setting.....	5-17
<b>5-6</b>	<b>Using the Key Protect Level</b> .....	<b>5-18</b>
5-6-1	Protection .....	5-18
5-6-2	Entering the Password to Move to the Protect Level.....	5-19
<b>5-7</b>	<b>Hiding Parameters</b> .....	<b>5-21</b>
5-7-1	Parameter Mask Settings .....	5-21
<b>5-8</b>	<b>OR Output of Alarms</b> .....	<b>5-23</b>
5-8-1	Integrated Alarm .....	5-23
<b>5-9</b>	<b>Alarm Delays</b> .....	<b>5-25</b>
5-9-1	Alarm Delays.....	5-25
<b>5-10</b>	<b>Loop Burnout Alarm (Not Supported for Position-proportional Models.)</b> .....	<b>5-27</b>
5-10-1	Loop Burnout Alarm (LBA).....	5-27
<b>5-11</b>	<b>Performing Manual Control</b> .....	<b>5-31</b>
5-11-1	Manual MV .....	5-31
<b>5-12</b>	<b>Using the Transfer Output</b> .....	<b>5-34</b>
5-12-1	Transfer Output Function.....	5-34
<b>5-13</b>	<b>Using PID Sets</b> .....	<b>5-37</b>
5-13-1	PID Sets .....	5-37
5-13-2	Settings for PID Sets .....	5-41
5-13-3	Setting PID Set Parameters .....	5-44

<b>5-14</b>	<b>Determining PID Constants for PID Sets (Autotuning for All PID Sets)</b> .....	<b>5-45</b>
5-14-1	Autotuning All PID Sets (Autotuning) .....	5-45
5-14-2	Executing Autotuning for All PID Sets .....	5-48
<b>5-15</b>	<b>Program-related Functions</b> .....	<b>5-53</b>
5-15-1	Advance .....	5-53
5-15-2	Segment Jump .....	5-54
5-15-3	Hold .....	5-54
5-15-4	Wait .....	5-55
5-15-5	Program Repetition .....	5-56
5-15-6	Program Links .....	5-56
5-15-7	SP Shift .....	5-57
5-15-8	Time Signals .....	5-57
5-15-9	Program end outputs .....	5-59
5-15-10	RUN Output .....	5-60
5-15-11	Stage Outputs .....	5-61
5-15-12	PV Start .....	5-61
5-15-13	Standby Operation .....	5-63
5-15-14	Changing the SP Mode .....	5-64
5-15-15	SP Tracking .....	5-65
5-15-16	Operations Related to Other Functions .....	5-66
<b>5-16</b>	<b>Output Adjustment Functions</b> .....	<b>5-67</b>
5-16-1	Output Limits .....	5-67
5-16-2	MV at Reset .....	5-67
5-16-3	MV at PV Error .....	5-68
<b>5-17</b>	<b>Using the Extraction of Square Root Parameter</b> .....	<b>5-70</b>
5-17-1	Extraction of Square Roots .....	5-70
<b>5-18</b>	<b>Setting the Width of MV Variation</b> .....	<b>5-72</b>
5-18-1	MV Change Rate Limit .....	5-72
<b>5-19</b>	<b>Setting the PF Key</b> .....	<b>5-74</b>
5-19-1	PF Setting (Function Key) .....	5-74
<b>5-20</b>	<b>Displaying PV/SV Status</b> .....	<b>5-77</b>
5-20-1	PV and SV Status Display Functions .....	5-77
<b>5-21</b>	<b>Controlling Valves (Can Be Used with a Position-proportional Model)</b> .....	<b>5-79</b>
<b>5-22</b>	<b>Logic Operations</b> .....	<b>5-82</b>
5-22-1	The Logic Operation Function (CX-Thermo) .....	5-82
5-22-2	Using Logic Operations .....	5-82
<b>5-23</b>	<b>Using the CX-Thermo to Set Programs</b> .....	<b>5-91</b>
5-23-1	Introduction .....	5-91
5-23-2	Using the Program Setting Functions .....	5-92
5-23-3	Names and Functions of Objects in the Programmer Editor .....	5-93
5-23-4	Program Setting Procedures .....	5-97

## Section 6 Parameters

---

<b>6-1</b>	<b>Conventions Used in this Section</b> .....	<b>6-2</b>
<b>6-2</b>	<b>Protect Level</b> .....	<b>6-3</b>
<b>6-3</b>	<b>Operation Level</b> .....	<b>6-7</b>
<b>6-4</b>	<b>Program Setting Level</b> .....	<b>6-16</b>
<b>6-5</b>	<b>Adjustment Level</b> .....	<b>6-24</b>
<b>6-6</b>	<b>PID Setting Level</b> .....	<b>6-44</b>
<b>6-7</b>	<b>Monitor/Setting Item Level</b> .....	<b>6-50</b>
<b>6-8</b>	<b>Manual Control Level</b> .....	<b>6-52</b>
<b>6-9</b>	<b>Initial Setting Level</b> .....	<b>6-54</b>

6-10	Advanced Function Setting Level .....	6-80
6-11	Communications Setting Level .....	6-111

## Section 7 User Calibration

---

7-1	User Calibration .....	7-2
7-2	Parameter Structure .....	7-3
7-3	Thermocouple Calibration .....	7-4
7-4	Resistance Thermometer Calibration .....	7-7
7-5	Calibrating Analog Input .....	7-9
7-6	Calibrating the Transfer Output.....	7-11
7-7	Checking Indication Accuracy .....	7-13

## Section A Appendices

---

<b>A-1</b>	<b>Specifications .....</b>	<b>A-2</b>
A-1-1	Ratings .....	A-2
A-1-2	Characteristics .....	A-4
A-1-3	Program Controls .....	A-5
A-1-4	Waterproof Packing.....	A-6
A-1-5	Setup Tool Port Cover for Front Panel.....	A-7
<b>A-2</b>	<b>Current Transformer (CT).....</b>	<b>A-8</b>
A-2-1	Specifications.....	A-8
A-2-2	Dimensions (Unit: mm).....	A-8
<b>A-3</b>	<b>USB-Serial Conversion Cable and Conversion Cable .....</b>	<b>A-9</b>
A-3-1	E58-CIFQ2 USB-Serial Conversion Cable.....	A-9
A-3-2	E58-CIFQ2-E Conversion Cable .....	A-10
<b>A-4</b>	<b>Error Displays .....</b>	<b>A-11</b>
<b>A-5</b>	<b>Troubleshooting.....</b>	<b>A-15</b>
<b>A-6</b>	<b>Parameter Operation Lists .....</b>	<b>A-18</b>
A-6-1	Operation Level .....	A-18
A-6-2	Program Setting Level.....	A-19
A-6-3	Adjustment Level.....	A-20
A-6-4	PID Setting Level.....	A-22
A-6-5	Initial Setting Level .....	A-23
A-6-6	Manual Control Level .....	A-26
A-6-7	Monitor/Setting Item Level.....	A-26
A-6-8	Advanced Function Setting Level .....	A-27
A-6-9	Protect Level .....	A-31
A-6-10	Communications Setting Level.....	A-32
A-6-11	Initialization According to Parameter Changes .....	A-33
<b>A-7</b>	<b>Sensor Input Setting Range, Indication Range, Control Range.....</b>	<b>A-36</b>
<b>A-8</b>	<b>Setting Levels Diagram .....</b>	<b>A-37</b>
<b>A-9</b>	<b>Parameter Flow .....</b>	<b>A-38</b>

## Index

---

# 1

## Introduction

---

---

<b>1-1</b>	<b>Appearance, Features, and Functions of the E5□C-T</b>	<b>1-2</b>
1-1-1	Appearance	1-2
1-1-2	Features	1-2
1-1-3	Main Functions	1-3
<b>1-2</b>	<b>I/O Configuration and Model Number Legend</b>	<b>1-5</b>
1-2-1	I/O Configuration	1-5
1-2-2	Model Number Legends	1-7

# 1-1 Appearance, Features, and Functions of the E5□C-T

## 1-1-1 Appearance

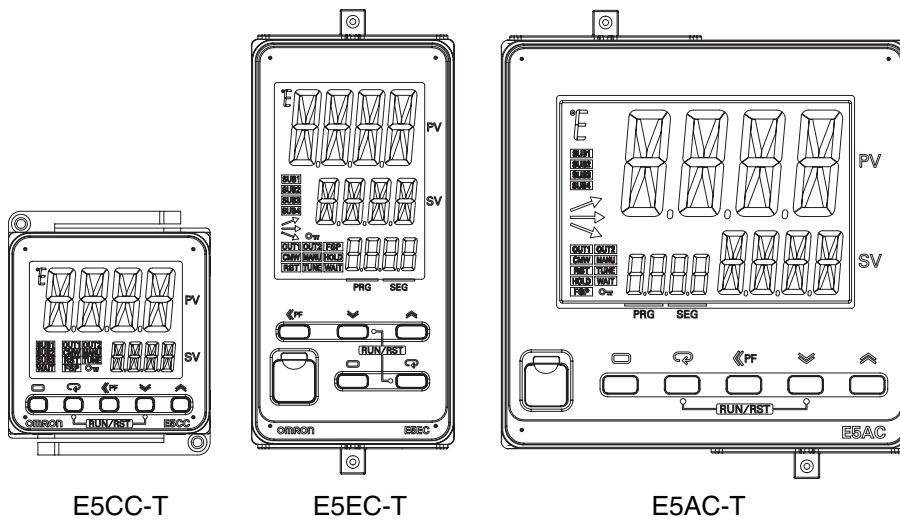

- A stylish design that gives a new look to control panels.
- Large display characters and white backlight for better visibility.
- A compact size to help downsize control panels.
- Much faster sampling and greater expandability than expected in this class of Controller.
- Even easier to use than previous models.

## 1-1-2 Features

This section compares the features of the E5□C-T with the previous E5□N-HT Controllers.

### High-speed Control Capability

Input sampling cycle: 50 ms  
 Control period: 0.1 s and 0.2 s have been added.  
 Integral/differential time unit: Setting in increments of 0.1 s has been added.

### I/O Expandability

- Number of event inputs: Increased from 2 to 4 for the E5CC-T and from 4 to 6 for the E5EC-T/E5AC-T.
- Number of auxiliary outputs: Increased from 2 to 3 for the E5CC-T and from 3 to 4 for the E5EC-T/E5AC-T.

### Easier Numeric Inputs with a Digit Shift Key

Digit shift: When setting the SP or other parameters, you can use a Shift Key (i.e., the PF Key) to shift the digit that is being set to aid in changing the set values.

### Setup Tool Port on Front Panel of the E5EC-T/E5AC-T

This port allows you to change or set parameters from the Setup Tool even when the Controller is installed in a panel.

## Controlling the Program

You can use a key operation to freely jump to another segment and execute it.



## Editing the Program

From the initial display in Operation Level, you can change to the display to edit segment data with one key.

## AT for All PID Sets

When you use more than one PID set, you can set all of the PID constants at the same time to reduce adjustment work.

## Addition of Operation to Change Program between Run and Reset

You can press the  (Mode) Key and the  Key simultaneously for 1 second or longer to change the program between run status and reset status.

## Parameter Mask Settings

You can use key operations to hide parameters that do not need to be displayed to prevent incorrectly setting parameters and to simplify the parameter configuration.

### 1-1-3 Main Functions

For details on particular functions and how to use them, refer to *Section 3 Part Names and Basic Procedures* and following sections.

#### ● Input Sensor Types

You can connect the following sensors and signals to the universal input.

Thermocouple (temperature input):	K, J, T, E, L, U, N, R, S, B, W, PLII
Resistance thermometer (temperature input):	Pt100, JPt100
Infrared Temperature Sensor (temperature input):	ES1B
	10 to 70°C, 60 to 120°C, 115 to 165°C, 140 to 260°C
Current input (analog input):	4 to 20 mA DC, 0 to 20 mA DC
Voltage input (analog input):	1 to 5 VDC, 0 to 5 V DC, 0 to 10 V DC

#### ● Control Outputs

- A control output can be a relay output, voltage output (for driving SSR), or linear current output, depending on the model.

#### ● Program Controls Program Patterns

- Programs: 8 patterns max., Segments: 32 max. per program
- Program initial set point: Segment 0 set point, present value (PV), or fixed SP
- Program start time: Standby operation (delay) can be set.
- Repeating and linking programs are also possible.

#### Controlling the Program

- Run (program operation started)/Reset (program operation stopped)
- Advancing the segment

- Holding
- Waiting to advance to the next segment
- Jumping to segments with a key operation

### Program Status Outputs

- Time signals
- ON output in run status
- ON output at program end
- Stage outputs (one-pulse output at start of each segment)

### ● Adjusting PID Constants

- You can easily set the optimum PID constants for the current PID set or for all PID sets by performing AT (auto-tuning) with the limit cycle method .
- You can also add RT (robust tuning) to give priority to controlling stability.

### ● Alarms

#### Standard Alarms

- You can output an alarm when the deviation, process value, set point, or manipulated value reaches a specified value.
- You can also output alarms for the PV rate of change and for loop burnouts.
- If necessary, a more comprehensive alarm function can be achieved by setting a standby sequence, alarm hysteresis, auxiliary output close in alarm/open in alarm, alarm latch, alarm ON delay, and alarm OFF delay.

#### HB and HS Alarms

- With models with the optional HB and HS alarms, you can detect heater burnout and heater short alarms based on CT inputs.

#### Integrated Alarm

- You can output an integrated alarm if a standard alarm, HB alarm, or HS alarm turns ON.

### ● Event Inputs

- With any model that supports event inputs, you can use external contact or transistor inputs to achieve any of the following functions: You can control the following: changing programs (changing program number, 8 max.), changing between run and reset status, changing between automatic and manual operation, inverting direct/reverse operation, changing between program SP and fixed SP, 100% AT execute/cancel, 40% AT execute/cancel, 100% AT execute/cancel for all PID sets, 40% AT execute/cancel for all PID sets, setting change enable/disable, communications write enable/disable, canceling the alarm latch, hold/clear hold, advance, and wait enable/disable.

### ● Communications Functions

With any E5□C-T model that supports communications, you can use CompoWay/F, Modbus-RTU,<sup>\*1</sup> programless, and component communications.

<sup>\*1</sup> Modbus is a registered trademark of Schneider Electric.

### ● Transfer Output

With any model that provides a transfer output, you can output the set point, process value, manipulated variable, or other values as a 4 to 20-mA or 1 to 5-V transfer output.



# 1-2 I/O Configuration and Model Number Legend

## 1-2-1 I/O Configuration

### ● I/O Configuration of E5□C-T

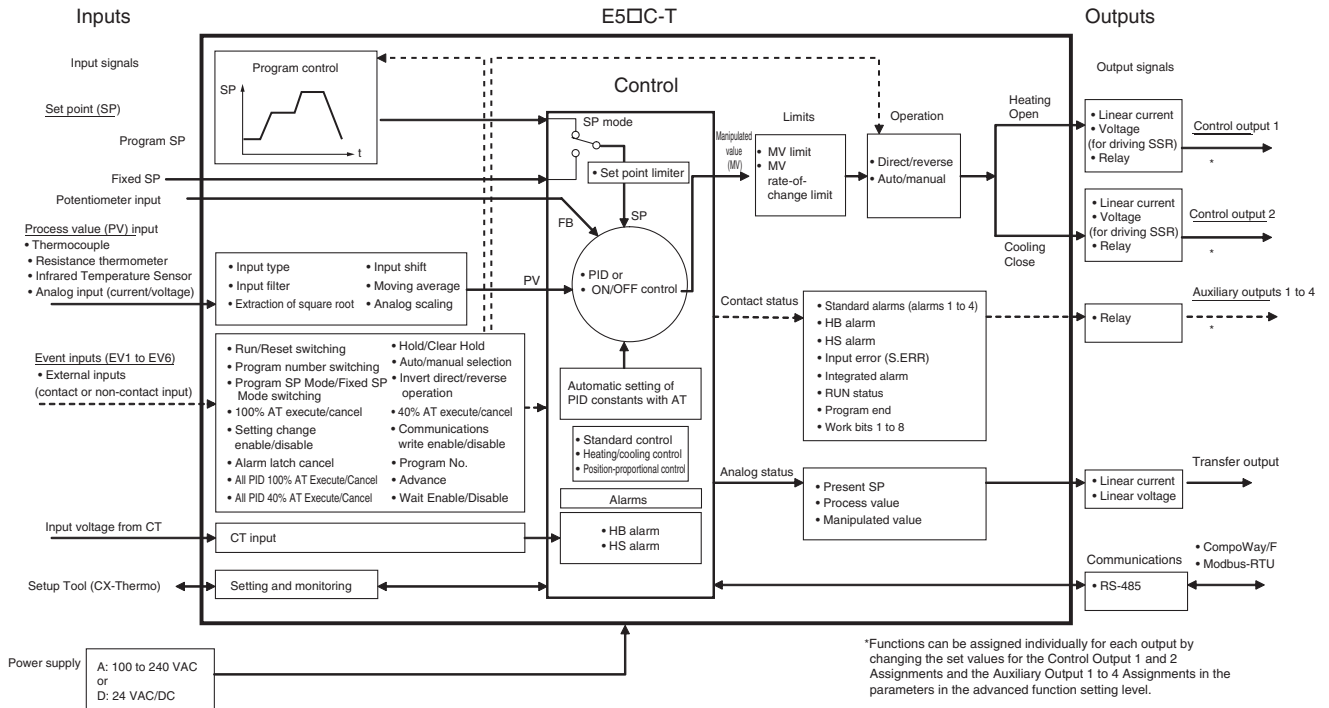

Note: Not all models support these functions. For details, refer to 1-2-2 Model Number Legends.

● I/O Related to Programmed Models

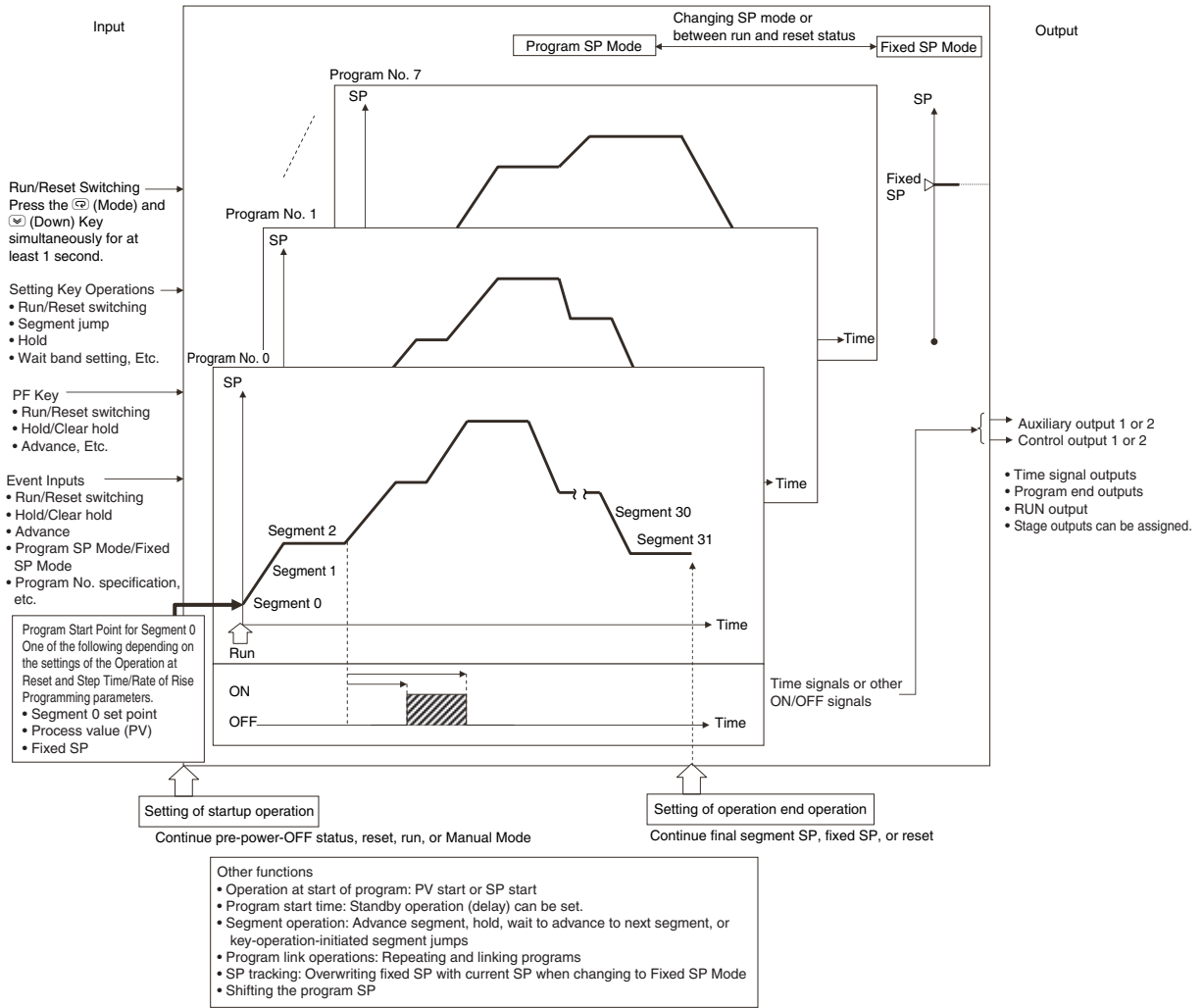

## 1-2-2 Model Number Legends

● E5CC-T

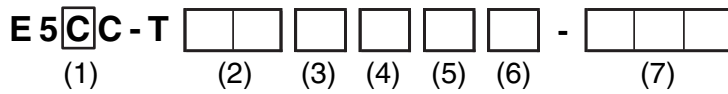

(1)	(2)	(3)	(4)	(5)	(6)	(7)	Meaning					
C							48 × 48 mm					
*2*1	R	X					Control output 1		Control output 2			
	Q	X					Relay output		None			
	C	X					Voltage output (for driving SSR)		None			
	Q	Q					Linear current output		None			
	Q	Q					Voltage output (for driving SSR)		Voltage output (for driving SSR)			
*2	C	Q					Linear current output		Voltage output (for driving SSR)			
		3					3					
		A					100 to 240 VAC					
		D					24 VAC/DC					
		S					Screw terminals					
		5					Screw terminals (with cover)					
		M					Universal input					
							Event inputs	Communications	HB alarm and HS alarm	Transfer output		
							000	---	---	---		
							001	2	---	1		
						*3	002	---	RS-485	1		
							003	---	RS-485	2 (for 3-phase heaters)		
							004	2	RS-485	---		
							005	4	---	---		
							006	2	---	---	Provided.	

\*1 Options with HB and HS alarms (001, 002, or 003) cannot be selected.  
 \*2 The linear current output cannot be used as a transfer output.  
 \*3 This cannot be selected if 5 (screw terminals with cover) is selected for the terminal type.

● E5EC/AC-T

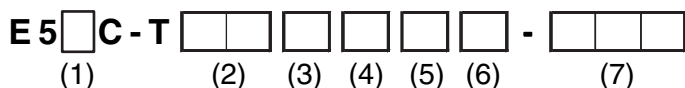

(1)	(2)	(3)	(4)	(5)	(6)	(7)	Meaning						
Size	Control Outputs 1 and 2	No. of auxiliary outputs	Power supply voltage	Terminal type	Input type	Options							
E							48 × 96 mm						
A							96 × 96 mm						
							Control output 1	Control output 2					
*1	R	X					Relay output	None					
*1	Q	X					Voltage output (for driving SSR)	None					
*2*1	C	X					Linear current output	None					
*1	Q	Q					Voltage output (for driving SSR)	Voltage output (for driving SSR)					
*1	Q	R					Voltage output (for driving SSR)	Relay output					
*1	R	R					Relay output	Relay output					
*2*1	C	C					Linear current output	Linear current output					
*2*1	C	Q					Linear current output	Voltage output (for driving SSR)					
*1	P	R					Position-proportional relay output	Position-proportional relay output					
		4					4						
			A				100 to 240 VAC						
			D				24 VAC/DC						
				S			Screw terminals						
					5		Screw terminals (with cover)						
						M	Universal input						
							Event inputs	Communications	HB alarm and HS alarm	Transfer output	For RX, QX, RR, QQ, QR, or CQ	For CX or CC	For PR
							000	---	---	---	Selectable	Selectable	Selectable
							004	2	RS-485	---	---	Selectable	Selectable
							005	4	---	---	---	Selectable	---
							008	2	RS-485	1	---	Selectable	---
							010	4	---	1	---	Selectable	---
							019	6	---	1	Provided.	Selectable	---
						*3	020	4	RS-485	2 (for 3-phase heaters)	Provided.	Selectable	---
							021	6	---	---	Provided.	---	Selectable
							022	4	RS-485	---	Provided.	---	Selectable

- \*1 The options that can be selected depend on the type of control output.
- \*2 The linear current output cannot be used as a transfer output.
- \*3 This cannot be selected if 5 (screw terminals with cover) is selected for the terminal type.

# 2

## Preparations

---

<b>2-1</b>	<b>Installation</b> .....	<b>2-2</b>
2-1-1	Dimensions (Unit: mm) .....	2-2
2-1-2	Panel Cutout (Unit: mm) .....	2-3
2-1-3	Mounting .....	2-5
<b>2-2</b>	<b>Using the Terminals</b> .....	<b>2-7</b>
2-2-1	E5CC-T Terminal Block Wiring Example .....	2-7
2-2-2	E5EC-T/E5AC-T Terminal Block Wiring Example .....	2-11
2-2-3	Precautions when Wiring .....	2-16
2-2-4	Wiring .....	2-16
<b>2-3</b>	<b>Insulation Block Diagrams</b> .....	<b>2-23</b>
<b>2-4</b>	<b>Using the Setup Tool Port</b> .....	<b>2-24</b>
2-4-1	Procedure .....	2-24
2-4-2	Connection Method .....	2-24
2-4-3	Installing the Driver .....	2-27

# 2-1 Installation

## 2-1-1 Dimensions (Unit: mm)

● E5CC-T

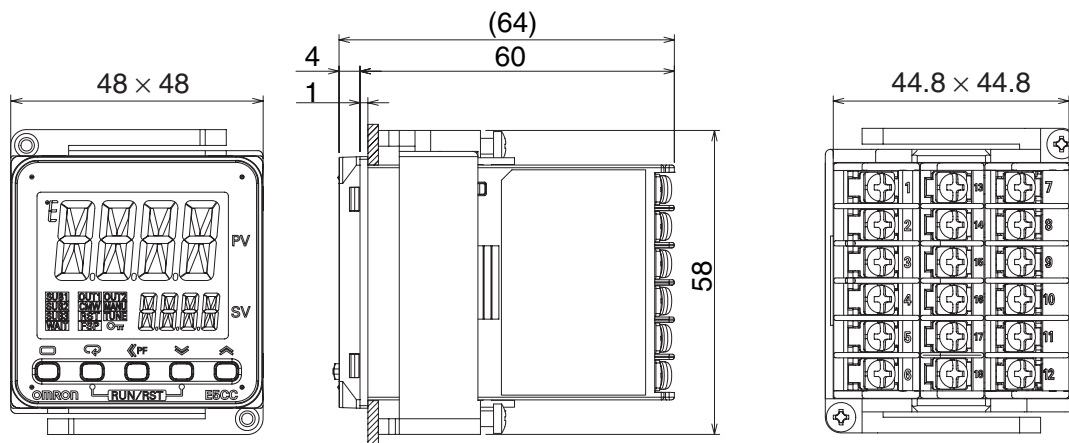

● E5EC-T

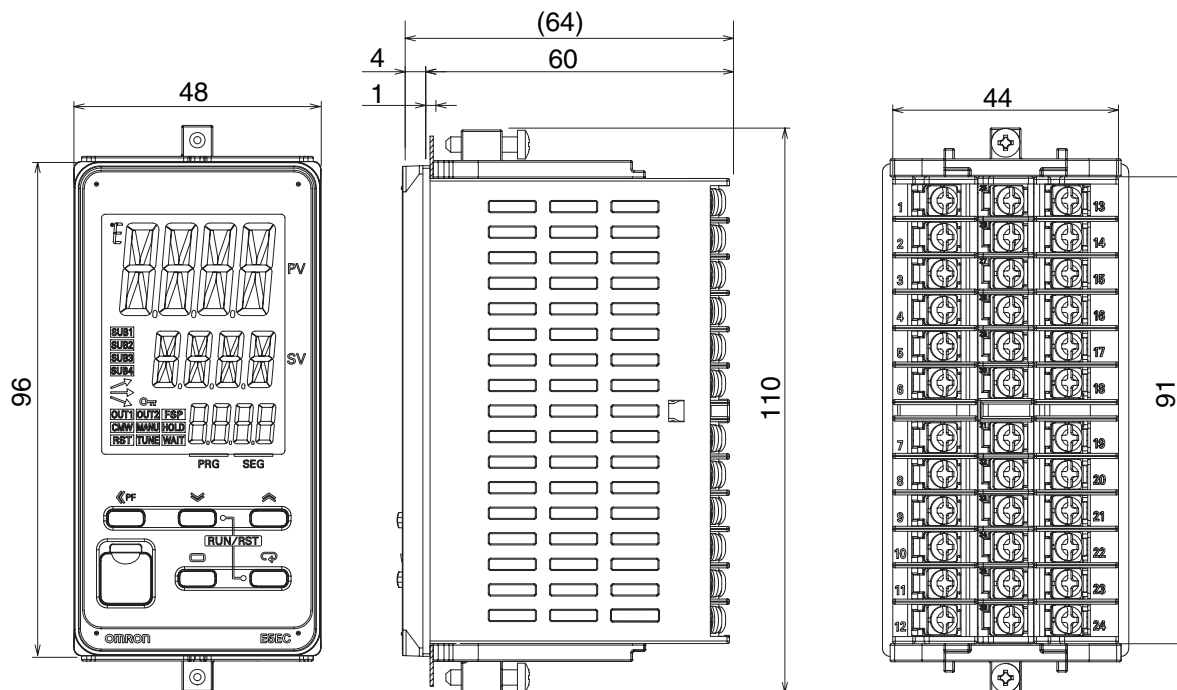

● E5AC-T

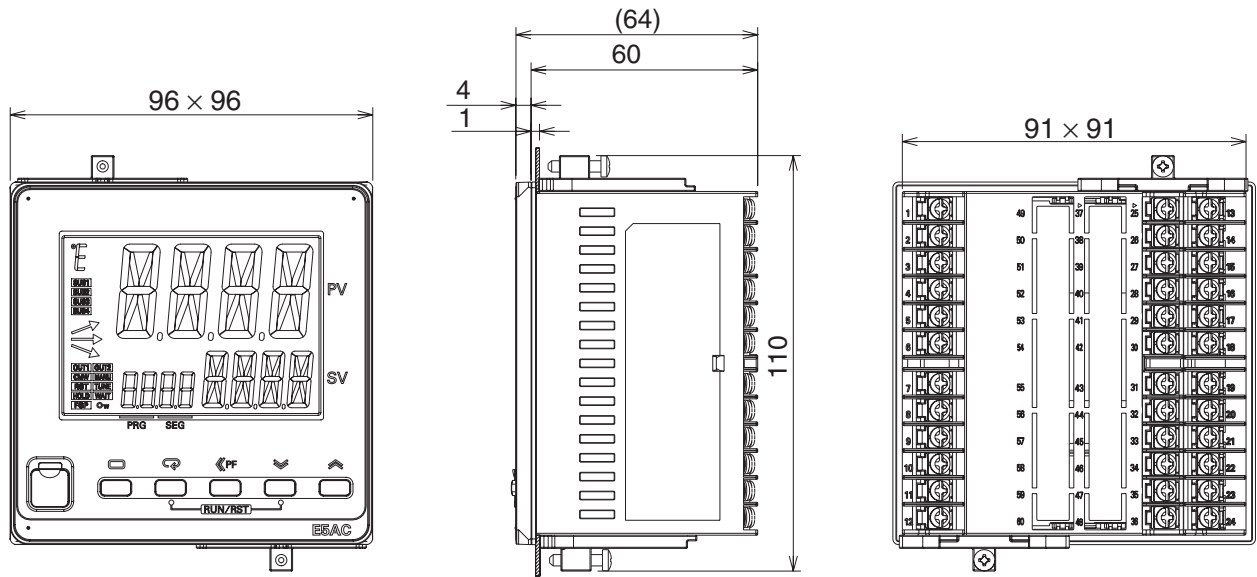

2-1 Installation  
2  
2-1-2 Panel Cutout (Unit: mm)

2-1-2 Panel Cutout (Unit: mm)

● E5CC-T

Individual Mounting

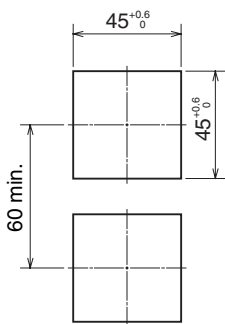

Group Mounting

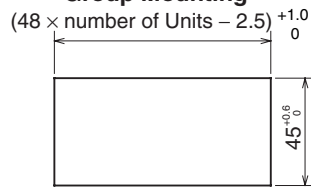

● E5EC-T

Individual Mounting

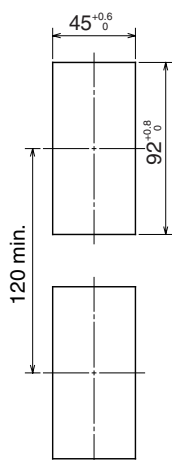

Group Mounting\*

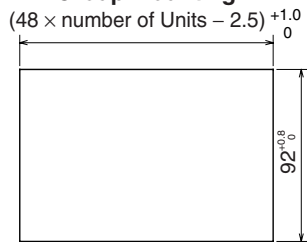





## 2-1-3 Mounting

### ● E5CC-T

There are two models of Terminal Covers that you can use with the E5CC-T.

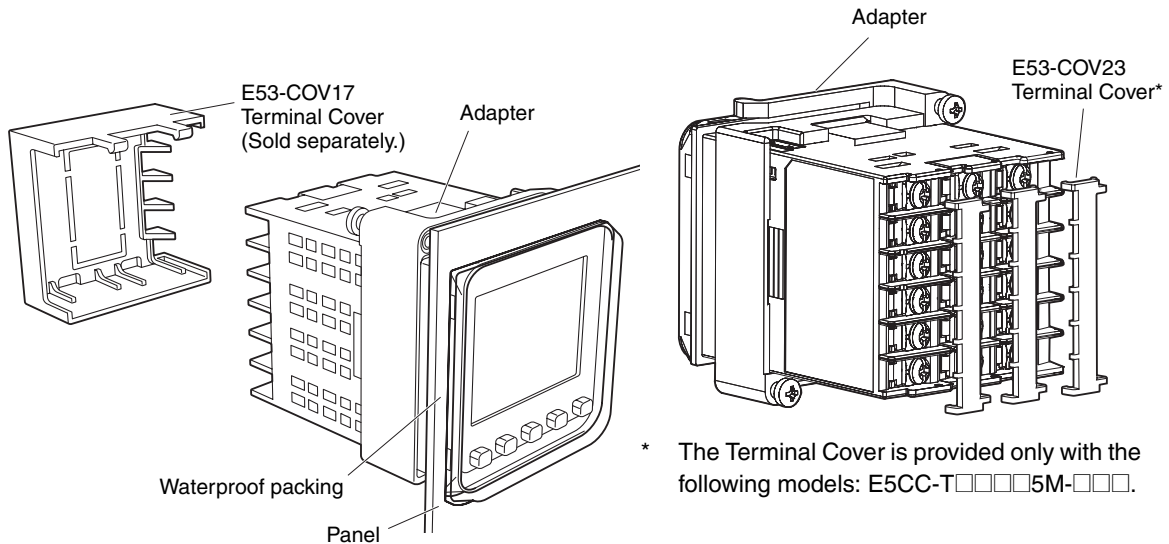

\* The Terminal Cover is provided only with the following models: E5CC-T□□□□5M-□□□.

### Mounting to the Panel

- (1) For waterproof mounting, waterproof packing must be installed on the Controller. Waterproofing is not possible when group mounting several Controllers. Waterproof packing is not necessary when there is no need for the waterproofing function.
- (2) Insert the E5CC-T into the mounting hole in the panel.
- (3) Push the Adapter from the terminals up to the panel, and temporarily fasten the E5CC-T.
- (4) Tighten the two fastening screws on the Adapter. Alternately tighten the two screws little by little to maintain a balance. Tighten the screws to a torque of 0.29 to 0.39 N·m.

### Mounting the Terminal Cover

Slightly bend the E53-COV23 Terminal Cover to attach it to the terminal block as shown in the following diagram. The Terminal Cover cannot be attached in the opposite direction. Or, you can use the E53-COV17 Terminal Cover. Make sure that the “UP” mark is facing up, and then attach the E53-COV17 Terminal Cover to the holes on the top and bottom of the Digital Controller.

#### ● E53-COV17

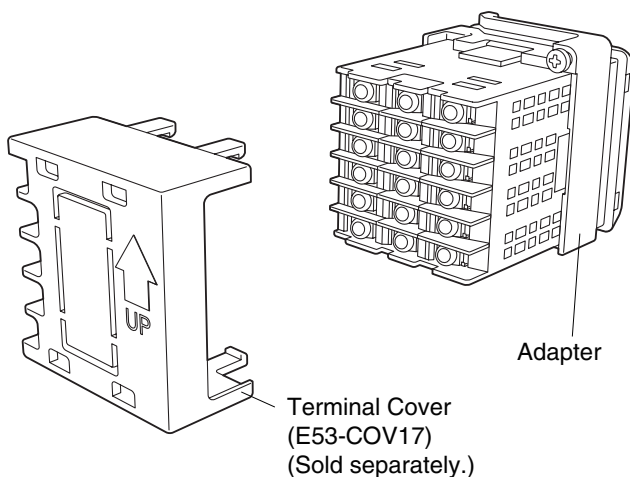

#### ● E53-COV23

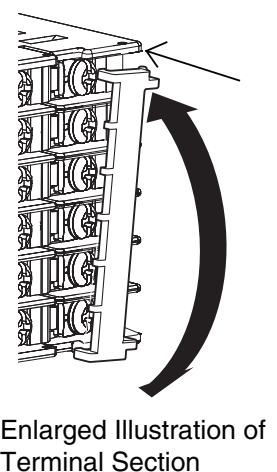

● E5EC-T/E5AC-T

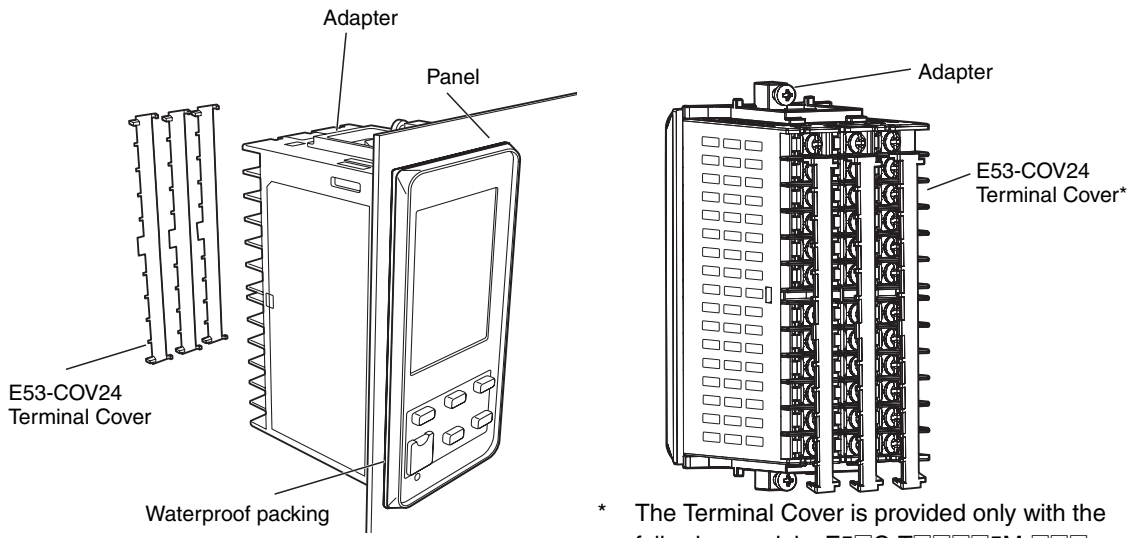

\* The Terminal Cover is provided only with the following models: E5□C-T□□□□5M-□□□.

**Mounting to the Panel**

- (1) For waterproof mounting, waterproof packing must be installed on the Controller. Waterproofing is not possible when group mounting several Controllers. Waterproof packing is not necessary when there is no need for the waterproofing function.
- (2) Insert the E5EC-T/E5AC-T into the mounting hole in the panel.
- (3) Push the Adapter from the terminals up to the panel, and temporarily fasten the E5EC-T/E5AC-T.
- (4) Tighten the two fastening screws on the Adapter. Alternately tighten the two screws little by little to maintain a balance. Tighten the screws to a torque of 0.29 to 0.39 N·m.

**Mounting the Terminal Cover**

Slightly bend the E53-COV24 Terminal Cover to attach it to the terminal block as shown in the following diagram. The Terminal Cover cannot be attached in the opposite direction.

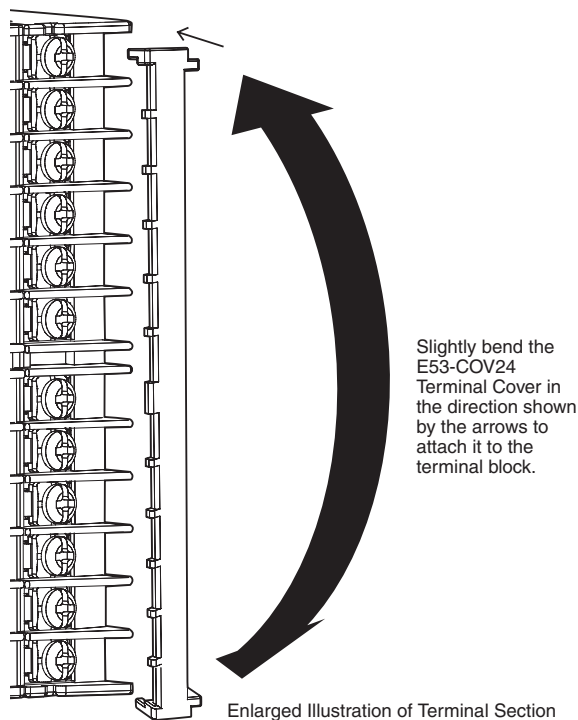

Slightly bend the E53-COV24 Terminal Cover in the direction shown by the arrows to attach it to the terminal block.

Enlarged Illustration of Terminal Section

## 2-2 Using the Terminals

### 2-2-1 E5CC-T Terminal Block Wiring Example

#### ● Terminal Arrangement

The terminals block of the E5CC-T is divided into five types of terminals: control outputs 1 and 2, sensor input, auxiliary outputs, input power supply, and options.

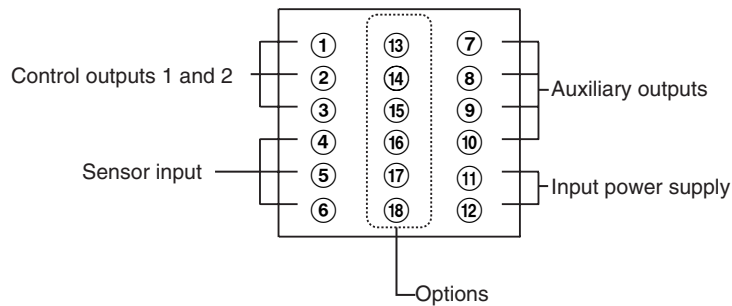

#### Precautions for Correct Use

When you purchase the Digital Controller, it will be set for a K thermocouple (input type = 5) by default. If a different sensor is used, an input error (*5.ERR*) will occur. Check the setting of the Input Type parameter.

### Control Outputs 1 and 2

#### ● Model Numbers

The specifications for control outputs 1 and 2 are given in the following location in the model number.

E5CC-T□□ □ □ □ M-□□□□

Control outputs 1 and 2

Code	Output type	Specification
RX	1 relay output	250 VAC, 3 A (resistive load)
QX	1 voltage output (for driving SSR)	12 VDC, 21 mA
CX	1 linear current output	4 to 20 mA DC or 0 to 20 mA DC with load of 500 Ω max.
QQ	2 voltage outputs (for driving SSRs)	12 VDC, 21 mA
CQ	1 linear current output and 1 voltage output (for driving SSRs)	4 to 20 mA DC or 0 to 20 mA DC with load of 500 Ω max. for current output and 12 VDC, 21 mA for voltage output

● **Terminal Details**

Do not connect anything to the terminals that are shaded gray.

RX	QX	CQ
CX	QQ	

**Sensor Input**

● **Model Numbers**

All E5CC-T models have universal sensor inputs, so the code in the model number is always “M.”

E5CC-T□□ □ □ □ M-□□□□



● **Terminal Details**

Do not connect anything to the terminals that are shaded gray.

TC (thermocouple)	Pt (resistance thermometer)	I (current)	V (voltage)



**Precautions for Correct Use**

When complying with EMC standards, the line connecting the sensor must be 30 m or less. If the cable length exceeds 30 m, compliance with EMC standards will not be possible.

## Auxiliary Outputs

### ● Model Numbers

The E5CC-T has three auxiliary outputs. The code in the model number is always 3.

E5CC-T□□ 3 □ □ M-□□□  
 └── No. of auxiliary outputs

Code	Auxiliary outputs	Specification
3	Model with 3 auxiliary outputs	SPST-NO, 250 VAC, 2 A

### ● Terminal Details

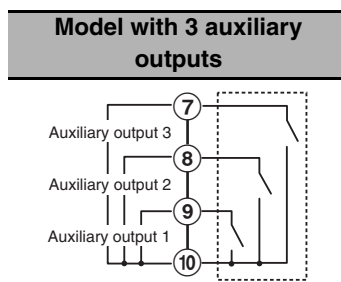

## Input Power Supply

### ● Model Numbers

The input power supply specification of the E5CC-T is given in the following location in the model number.

E5CC-T□□ □ □ M-□□□  
 └── Input power supply

Code	Specification	Power consumption
A	100 to 240 VAC, 50/60 Hz	7.5 VA max.
D	24 VAC, 50/60 Hz 24 VDC (no polarity)	4.1 VA max./2.3 W max.

### ● Terminal Details

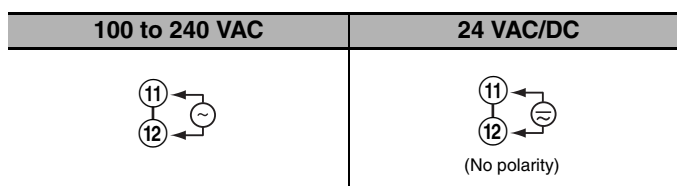

## Options

### ● Model Numbers

The options specification of the E5CC-T is given in the following location in the model number.

E5CC-T□□ □ □ □ M-□□□  
└── Options

Code	Specification	Remarks
000	None	
001	Event inputs 1 and 2, and CT1	
002*	Communications (RS-485) and CT1	
003	Communications (RS-485), CT1, and CT2	
004	Communications (RS-485), and event inputs 3 and 4	
005	Event inputs 1 to 4	
006	Event inputs 1 and 2, and transfer output	Transfer output: Current: 4 to 20 mA DC Voltage: 1 to 5 VDC

\* This cannot be selected if 5 (screw terminals with cover) is selected for the terminal type.

### ● Terminal Details

Do not connect anything to the terminals that are shaded gray.

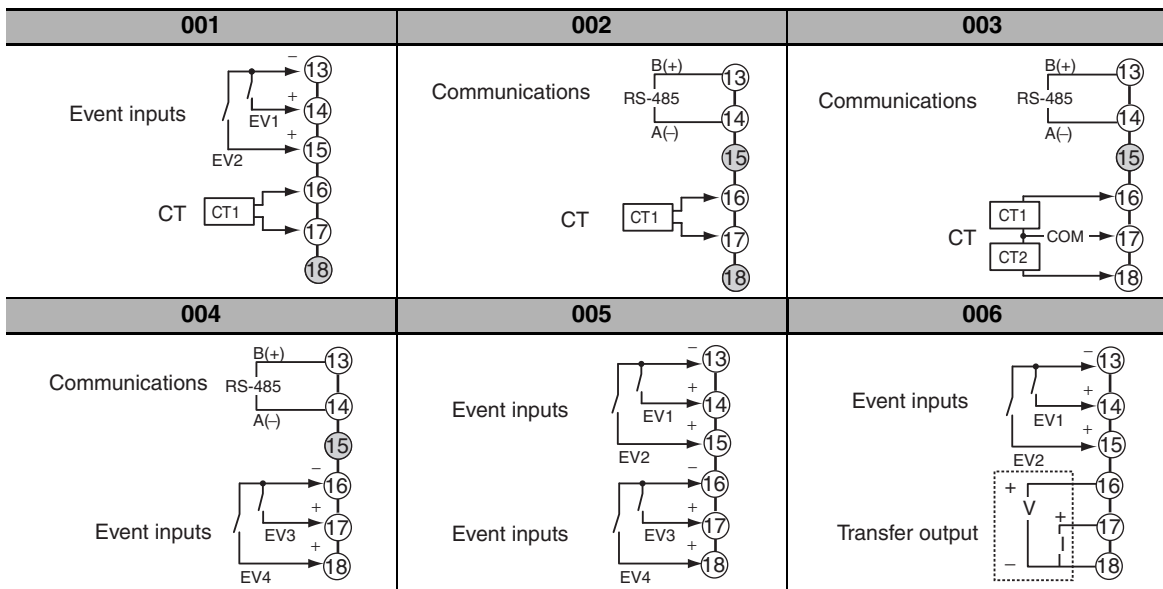

## 2-2-2 E5EC-T/E5AC-T Terminal Block Wiring Example

### ● Terminal Arrangement

The terminals block is divided into five types of terminals: control outputs 1 and 2, sensor input, auxiliary outputs, input power supply, and options.

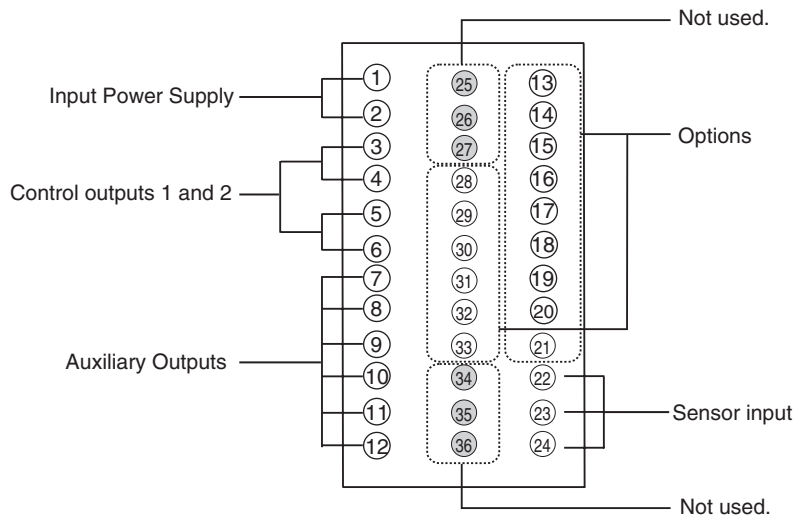

### Precautions for Correct Use

- When you purchase the Digital Controller, it will be set for a K thermocouple (input type = 5). If a different sensor is used, an input error (*5.ERR*) will occur. Check the setting of the Input Type parameter.

## Control Outputs 1 and 2

### ● Model Numbers

The specifications for control outputs 1 and 2 are given in the following location in the model number.

E5□C-T□□ □ □ □ M-□□□□

Control outputs 1 and 2

Code	Output type	Specification
RX	1 relay output	250 VAC, 5 A (resistive load)
QX	1 voltage output (for driving SSR)	12 VDC, 40 mA
CX	1 linear current output	4 to 20 mA DC or 0 to 20 mA DC with load of 500 Ω max.
QQ	2 voltage outputs (for driving SSRs)	12 VDC, 21 mA
QR	1 voltage output (for driving SSR) and 1 relay output	12 VDC, 21 mA for voltage output 250 VAC, 5 A (resistive load) for relay output
RR or PR	2 relay outputs	250 VAC, 5 A (resistive load)
CC	2 linear current outputs	4 to 20 mA DC or 0 to 20 mA DC with load of 500 Ω max.
CQ	1 linear current output and 1 voltage output (for driving SSRs)	4 to 20 mA DC or 0 to 20 mA DC with load of 500 Ω max. for current output and 12 VDC, 21 mA for voltage output

● **Terminal Details**

Do not connect anything to the terminals that are shaded gray.

RX	QX	CX
QQ	QR	RR
CC	PR	CQ

**Sensor Input**

● **Model Numbers**

All models have universal sensor inputs, so the code in the model number is always “M.”



● **Terminal Details**

Do not connect anything to the terminals that are shaded gray.

TC (thermocouple)	Pt (resistance thermometer)	I (current)	V (voltage)



**Precautions for Correct Use**

When complying with EMC standards, the line connecting the sensor must be 30 m or less. If the cable length exceeds 30 m, compliance with EMC standards will not be possible.



## Auxiliary Outputs

### ● Model Numbers

The following models have four auxiliary outputs. The code in the model number is always 4.

E5□C-T□□ 4 □ □ M-□□□

└─ No. of auxiliary outputs

Code	Auxiliary outputs	Specification
4	Model with 4 auxiliary outputs	SPST-NO, 250 VAC, 2 A

### ● Terminal Details

#### Model with 4 auxiliary outputs

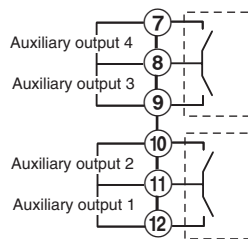

## Input Power Supply

### ● Model Numbers

The input power supply specification is given in the following location in the model number.

E5□C-T□□ □ □ M-□□□

└─ Input power supply

The codes that are given in the following table show the specification.

Code	Specification	E5EC-T	E5AC-T
A	100 to 240 VAC (50/60 Hz)	8.7 VA max.	9.0 VA max.
D	24 VAC, 50/60 Hz	5.5 VA max.	5.6 VA max.
	24 VDC (no polarity)	3.2 W max.	3.4 W max.

### ● Terminal Details

Details on the input power supply terminals are shown below.

100 to 240 VAC	24 VAC/DC

## Options

### ● Model Numbers

The options specification is given in the following location in the model number.

E5□C-T□□ □ □ □ M-□□□  
 └── Options

Code	Specification
000	None or potentiometer input (Position-proportional Models only)
004	Communications (RS-485), and event inputs 1 and 2 Potentiometer input (Position-proportional Models only)
005	Event inputs 1 to 4
008	Communications (RS-485), event inputs 1 and 2, and CT1
010	Event inputs 1 to 4, and CT1
019	Event inputs 1 to 6, CT1, and transfer output
020*	Communications (RS-485), event inputs 1, 2, 5, and 6, CT1, CT2, and transfer output
021	Event inputs 1 to 6 and transfer output
022	Communications (RS-485), event inputs 1, 2, 5, and 6, and transfer output Potentiometer input (Position-proportional Models only)

Transfer Output

Current: 4 to 20 mA DC

Voltage: 1 to 5 VDC

\* This cannot be selected if 5 (screw terminals with cover) is selected for the terminal type.

● Terminal Details

Do not connect anything to the terminals that are shaded gray.

000	004	005
008	010	019
020	021	022

\* Can be used for a Position-proportional Model. These terminals are not used on other models.

### 2-2-3 Precautions when Wiring

- Separate input leads and power lines in order to prevent external noise.
- Use a shielded, AWG24 to AWG18 (cross-sectional area of 0.205 to 0.823 mm<sup>2</sup>) twisted-pair cable. The stripping length is 6 to 8 mm.
- Use crimp terminals when wiring the terminals.
- Use the suitable wiring material and crimp tools for crimp terminals.
- Tighten the terminal screws to a torque of 0.43 to 0.58 N·m.
- Use the following types of crimp terminals for M3.0 screws.



### 2-2-4 Wiring

In the connection diagrams, the left side of the terminal numbers represents the inside of the Controller and the right side represents the outside.

#### ● Power Supply

##### Power Consumption

Input Power Supply	E5CC-T	E5EC-T	E5AC-T
100 to 240 VAC, 50/60 Hz	7.5 VA	8.7 VA	9.0 VA
24 VAC, 50/60 Hz	4.1 VA	5.5 VA	5.6 VA
24 VDC (no polarity)	2.3 W	3.2 W	3.4 W

- These models have reinforced insulation between the input power supply, the relay outputs, and other terminals.

#### ● Inputs

Refer to 2-2-1 *E5CC-T Terminal Block Wiring Example* or 2-2-2 *E5EC-T/E5AC-T Terminal Block Wiring Example* for the terminal arrangement. When extending the thermocouple lead wires, be sure to use compensating wires that match the thermocouple type. When extending the lead wires of a resistance thermometer, be sure to use wires that have low resistance and keep the resistance of the three lead wires the same.

● Control Outputs 1 and 2

The following diagrams show the applicable outputs and their internal equivalent circuits.

**E5CC-T**

RX (relay output)	QX (voltage output (for driving SSR))	CX (linear current output)	QQ (2 voltage outputs (for driving SSRs))	CQ (linear current and voltage output (for driving SSR))

Output type		Specification
RX	Relay output	SPST-NO, 250 VAC, 3 A (resistive load), Electrical life: 100,000 operations
QX	Voltage output (for driving SSR)	PNP, 12 VDC $\pm$ 20%, 21 mA (with short-circuit protection)
CX	Linear current output	4 to 20 or 0 to 20 mA DC, Load: 500 $\Omega$ max., Resolution: Approx. 10,000
QQ*	2 voltage outputs (for driving SSRs)	PNP, 12 VDC $\pm$ 20%, 21 mA (with short-circuit protection)
CQ*	Linear current output (control output 1)	4 to 20 or 0 to 20 mA DC, Load: 500 $\Omega$ max., Resolution: Approx. 10,000
	Voltage output (for driving SSR) (control output 2)	PNP, 12 VDC $\pm$ 20%, 21 mA (with short-circuit protection)

\* Control output 1 and control output 2 are not isolated.

**E5EC-T/E5AC-T**

RX (relay output)	QX (voltage output (for driving SSR))	CX (linear current output)	RR or PR (2 relays)
QQ (2 voltage outputs (for driving SSRs))	QR (voltage output (for driving SSR) and relay output)	CC (2 linear current outputs)	CQ (linear current and voltage output (for driving SSR))

Output type		Specification
RX	Relay output	SPST-NO, 250 VAC, 5 A (resistive load), Electrical life: 100,000 operations
QX	Voltage output (for driving SSR)	PNP, 12 VDC $\pm$ 20%, 40 mA (with short-circuit protection)
CX	Linear current output	4 to 20 or 0 to 20 mA DC, Load: 500 $\Omega$ max., Resolution: Approx. 10,000
RR or PR	2 relay outputs	SPST-NO, 250 VAC, 5 A (resistive load), Electrical life: 100,000 operations
QQ*	2 voltage outputs (for driving SSRs)	PNP, 12 VDC $\pm$ 20%, 21 mA (with short-circuit protection)
QR	Voltage output (for driving SSRs) (control output 1)	PNP, 12 VDC $\pm$ 20%, 21 mA (with short-circuit protection)
	Relay output (control output 2)	SPST-NO, 250 VAC, 5 A (resistive load), Electrical life: 100,000 operations
CC*	2 linear current outputs	4 to 20 or 0 to 20 mA DC, Load: 500 $\Omega$ max., Resolution: Approx. 10,000
CQ*	Linear current output (control output 1)	4 to 20 or 0 to 20 mA DC, Load: 500 $\Omega$ max., Resolution: Approx. 10,000
	Voltage output (for driving SSR) (control output 2)	PNP, 12 VDC $\pm$ 20%, 21 mA (with short-circuit protection)

\* Control output 1 and control output 2 are not isolated.

### ● Auxiliary Outputs 1 to 4

On the E5CC-T, when heating/cooling control is used, auxiliary output 2 becomes control output (cooling).

On the E5EC-T or E5AC-T, when heating/cooling control is used, auxiliary output 4 becomes control output (cooling).

● **Event Inputs**

Models with an option number of 001, 004 to 006, 008, 010, or 019 to 022 have event inputs.

**E5CC-T**

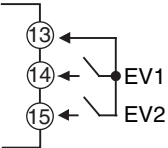
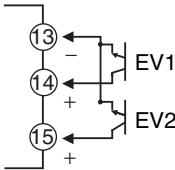
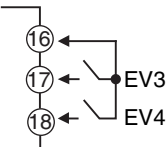
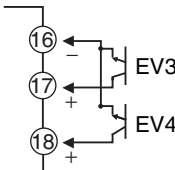
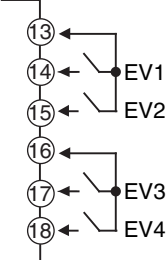
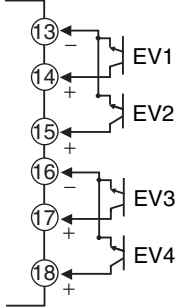
Contact inputs	Non-contact inputs
Option number: 001 or 006 	
Option number: 004 	
Option number: 005 	

**E5EC-T/E5AC-T**

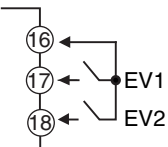
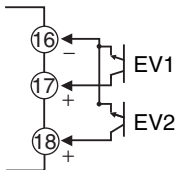
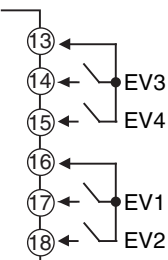
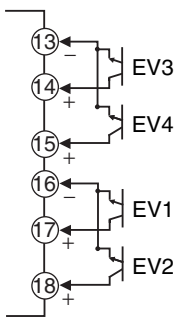
Contact inputs	Non-contact inputs
Option number: 004 or 008 	
Option number: 005 or 010 	

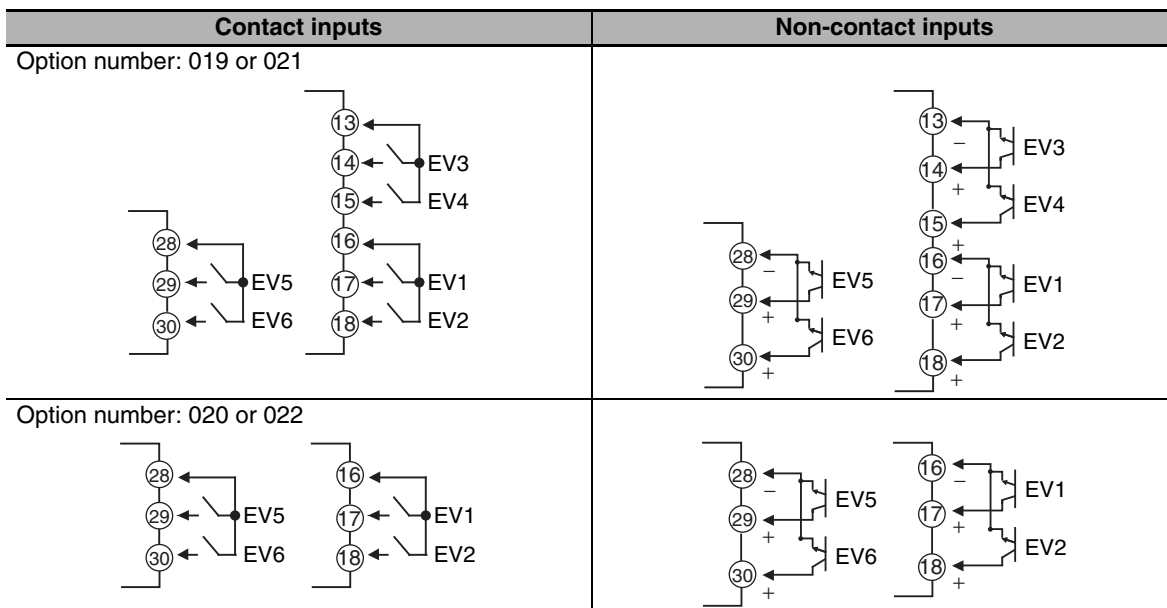

- Use event inputs under the following conditions:
- The outflow current is approximately 7 mA.

---

Contact input ON: 1 kΩ max., OFF: 100 kΩ min.

---

No-contact input ON: Residual voltage of 1.5 V max.; OFF: Leakage current of 0.1 mA max.

---

● **CT Inputs**

Models with an option number of 001 to 003, 008, 010, 019, or 020 have CT inputs.



## ● Transfer Output

Models with an option number of 006 or 019 to 022 have a transfer output.

### E5CC-T

Option number: 006

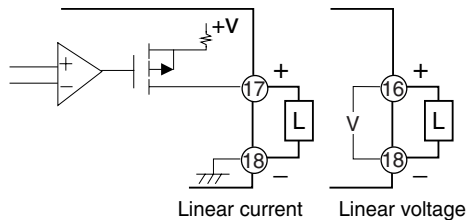

### E5EC-T/E5AC-T

Option number: 019, 020, 021, or 022

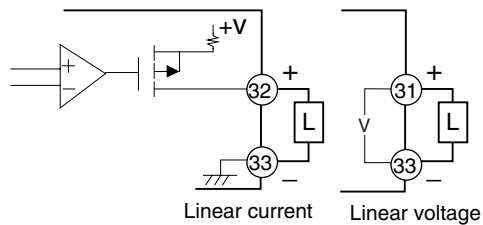

Output type	Specification
Linear current output	4 to 20 mA DC, Load: 500 $\Omega$ max., Resolution: 10,000
Linear voltage output	1 to 5 VDC, Load: 1 k $\Omega$ min., Resolution: 10,000

## ● Potentiometer Input

You can use this input for a Position-proportional Model. The maximum opening can be measured to between 100 and 10K $\Omega$ .

Note: The E5CC-T does not have a potentiometer input.

● **Communications**

**RS-485**

Models with an option number of 002 to 004, 008, 020, or 022 support RS-485 communications. Connect the communications cable across terminals 13 and 14.

**Communications Unit Connection Diagram**

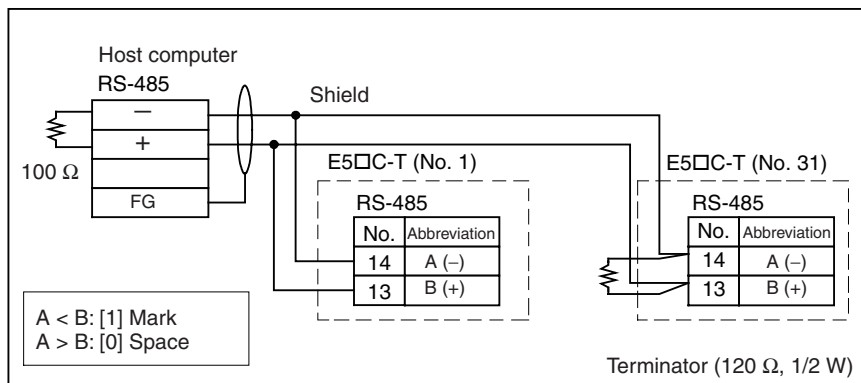

- The RS-485 connection can be either one-to-one or one-to-N. A maximum of 32 Units (including the host computer) can be connected in one-to-N systems. The maximum total cable length is 500 m. Use a shielded, AWG24 to AWG18 (cross-sectional area of 0.205 to 0.823 mm<sup>2</sup>) twisted-pair cable.

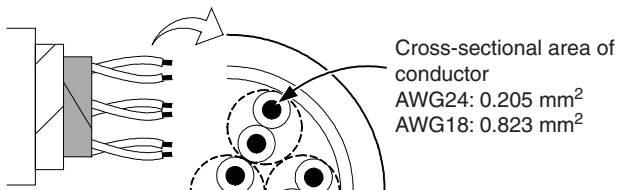

## 2-3 Insulation Block Diagrams

The insulation block diagrams are provided in this section.

### ● E5CC-T

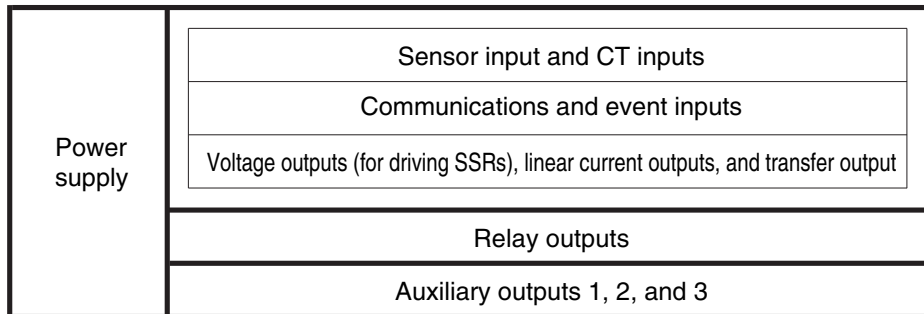

 : Reinforced insulation

 : Functional isolation

### ● E5EC-T/E5AC-T

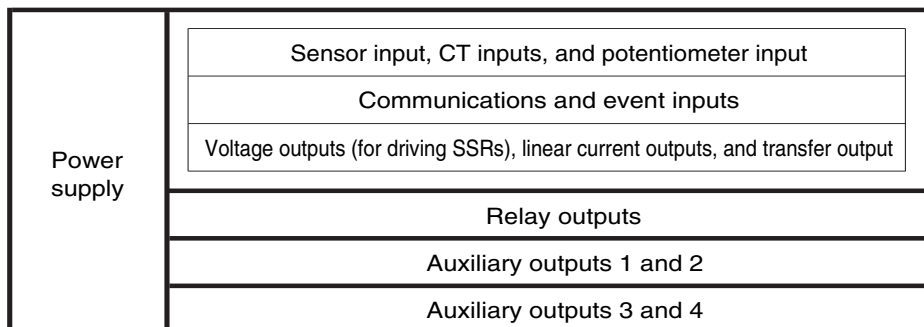

 : Reinforced insulation

 : Functional isolation

## 2-4 Using the Setup Tool Port

Use one of the Setup Tool ports to connect the computer to the Digital Controller when using the CX-Thermo or other Support Software.

The E58-CIFQ2 USB-Serial Conversion Cable\*<sup>1</sup> is required for the connection. For information on the models that can be used with CX-Thermo, contact your OMRON sales representative.

\*<sup>1</sup> The E58-CIFQ2-E is required to connect to the Setup Tool port on the front panel of the E5EC-T or E5AC-T.

### 2-4-1 Procedure

When the USB-Serial Conversion Cable is connected to the Digital Controller, the following operations are possible even if the power supply to the Digital Controller is not turned ON.

- Setting up the Digital Controller from a computer (Special software is required.)
- Changing settings by using key operations on the Digital Controller
- Displaying the current temperature on the Digital Controller

The control outputs, alarm outputs, transfer output, event inputs, and external communications for the Digital Controller will not operate unless the power supply to the Digital Controller is turned ON.

### 2-4-2 Connection Method

Use the E58-CIFQ2 USB-Serial Conversion Cable to connect the E5□C-T to the computer. The USB-Serial Conversion Cable is used to communicate with a USB port on a computer as a virtual COM port.

#### E5CC-T

##### ● Setup Tool Port and Connecting Cable

The location of the Setup Tool port on the E5CC-T and the required cable are shown below.

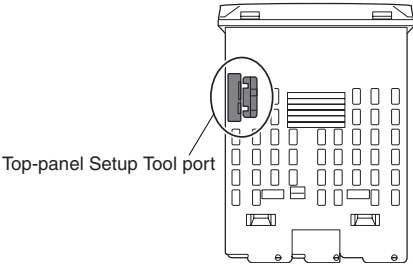
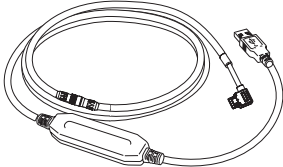
Setup Tool port	Connecting cable
<p data-bbox="376 1373 759 1402">• Top panel on the Digital Controller</p> 	<p data-bbox="1015 1402 1362 1424">E58-CIFQ2 USB-Serial Conversion Cable</p> 

● Connection Procedure

**1** Connect the serial connector on the USB-Serial Conversion Cable to the Setup Tool port on the top panel of the Digital Controller.

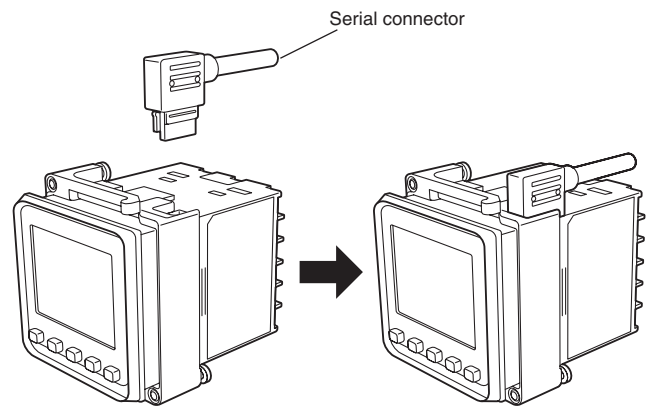

**E5EC-T/E5AC-T**

● Setup Tool Ports and Connecting Cables

The location of the Setup Tool port on the E5EC-T/E5AC-T and the required cable are shown below. There are Setup Tool ports on both the top panel and front panel of the Digital Controller.

Setup Tool ports		Connecting cables	
<ul style="list-style-type: none"> <li>• Top panel on the Digital Controller</li> </ul>	<ul style="list-style-type: none"> <li>• Front panel on the Digital Controller</li> </ul>	<p>E58-CIFQ2 USB-Serial Conversion Cable</p>	<p>E58-CIFQ2-E Conversion Cable*</p>

\* This Cable is required only to connect to the front-panel Setup Tool port.

● Connection Procedure

- Top-panel Port

**1** Connect the serial connector to the Setup Tool port on the top panel of the Digital Controller.

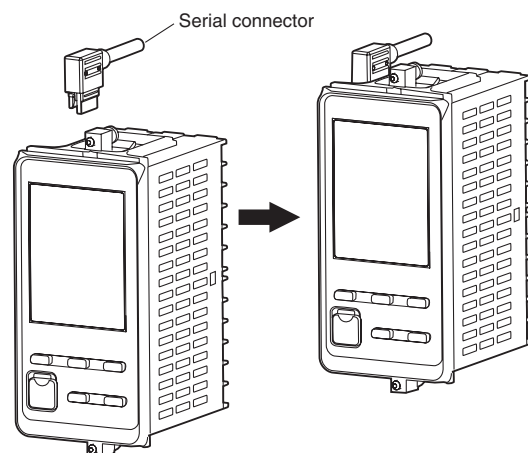

- Front-panel Port

**1** Connect the E58-CIFQ2 USB-Serial Conversion Cable to the E58-CIFQ2-E Conversion Cable.

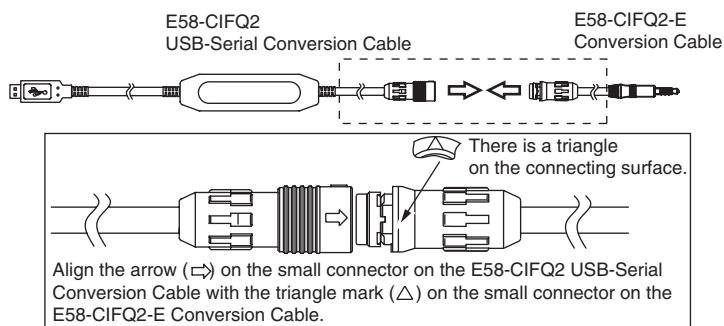

**2** Remove the Port Cover from the front-panel Setup Tool port, and then plug in the Conversion Cable.

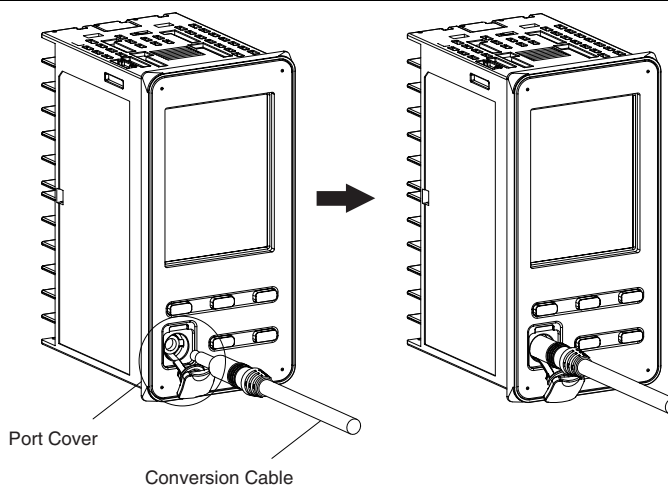

**Precautions for Correct Use**

- Hold the connector when inserting or disconnecting the Cable.
- When connecting a connector, always make sure that it is oriented correctly. Do not force the connector if it does not connect smoothly. Connectors may be damaged if they are connected with excessive force.
- Do not connect cables to both the front-panel Setup Tool port and the top-panel Setup Tool port at the same time. Damage or malfunction may occur.

### 2-4-3 Installing the Driver

**1. Connect a USB connector on the computer with a Setup Tool port on the Digital Controller using the Cable or Cables.**

**2. Obtaining the Driver**

When the CX-Thermo Support Software for the Digital Controller is installed, the driver for the USB-Serial Conversion Cable will be copied to the following folder.

C:\Program Files\OMRON\Drivers\USB\E58-CIF

**3. Installing the Driver**

Install the driver to enable the Cable to be used with the personal computer.

- Installation

When the Cable is connected with the personal computer, the OS will detect the product as a new device. At this time, install the driver using the Installation Wizard.

Note 1: We recommend that you install the driver for each USB port on the computer at the start. The Digital Controller assigns a COM port number to each USB port on the computer. If the same USB port is used, you will be able to use the same COM port number even if you use a different Cable.

2: Installation of the driver will not be completed if the installation is canceled before it is completed. Normal communications will not be possible unless the driver is installed completely. If the driver is not installed completely, uninstall it, and then install it correctly.

**4. Setting Setup Tool Communications Conditions**

Set the communications port (COM port) number to be used for the CX-Thermo Setup Tool to the COM port number assigned to the USB-Serial Conversion Cable.

Refer to the E58-CIFQ2 USB-Serial Conversion Cable Instruction Manual and Setup Manual for details on how to check the COM port assigned to the USB-Serial Conversion Cable.

The communications conditions for Setup Tool COM ports are fixed as shown in the table below. Set the communications conditions for the CX-Thermo Setup Tool according to the following table

Parameter	Set value
Communications Unit No.	01
Communications baud rate	38.4 (kbps)
Communications data length	7 (bits)
Communications stop bits	2 (bits)
Communications parity	Even





# 3

## Part Names and Basic Procedures

---

<b>3-1 Basic Application Flow</b> .....	<b>3-2</b>
<b>3-2 Power ON</b> .....	<b>3-3</b>
<b>3-3 Part Names, Part Functions, and Setting Levels</b> .....	<b>3-4</b>
3-3-1 Part Names and Functions .....	3-4
3-3-2 Entering Numeric Values .....	3-8
3-3-3 Setting Levels .....	3-9
<b>3-4 Procedures after Turning ON the Power Supply</b> .....	<b>3-14</b>
3-4-1 Basic Flow of Operations .....	3-14
3-4-2 Basic Procedure .....	3-15

# 3-1 Basic Application Flow

The following figure shows the basic flow for using the Digital Controller.

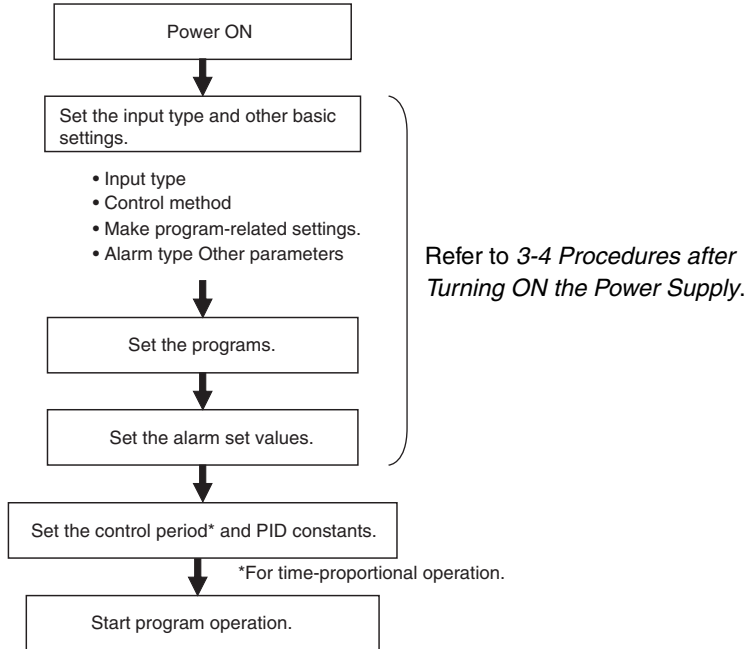

# 3-2 Power ON

After the power comes ON, all indicators and displays will light for approximately 1 second, and then the operation display will appear.

The top display will show the PV and the middle display will show the SP.

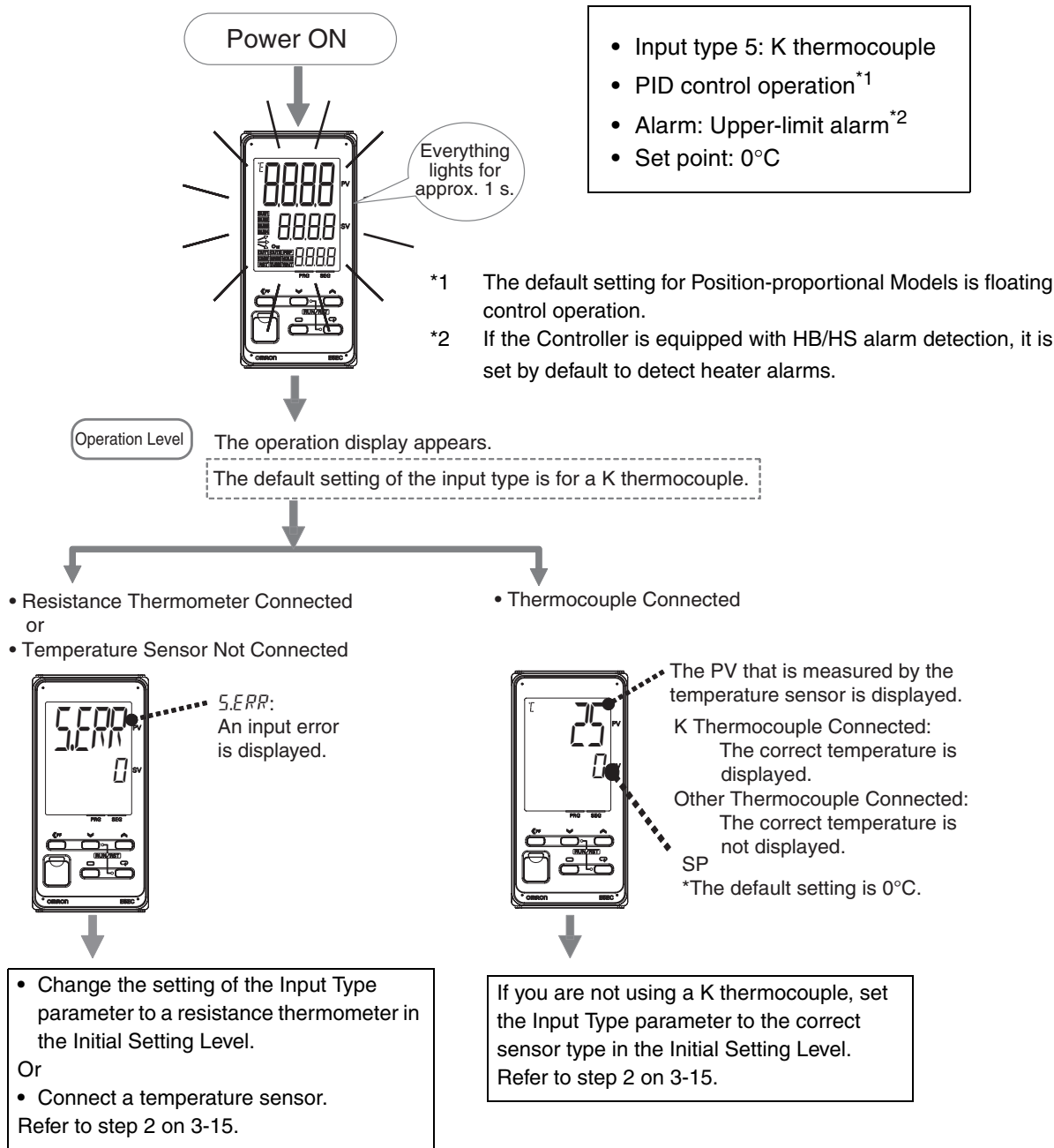

# 3-3 Part Names, Part Functions, and Setting Levels

## 3-3-1 Part Names and Functions

### E5CC-T

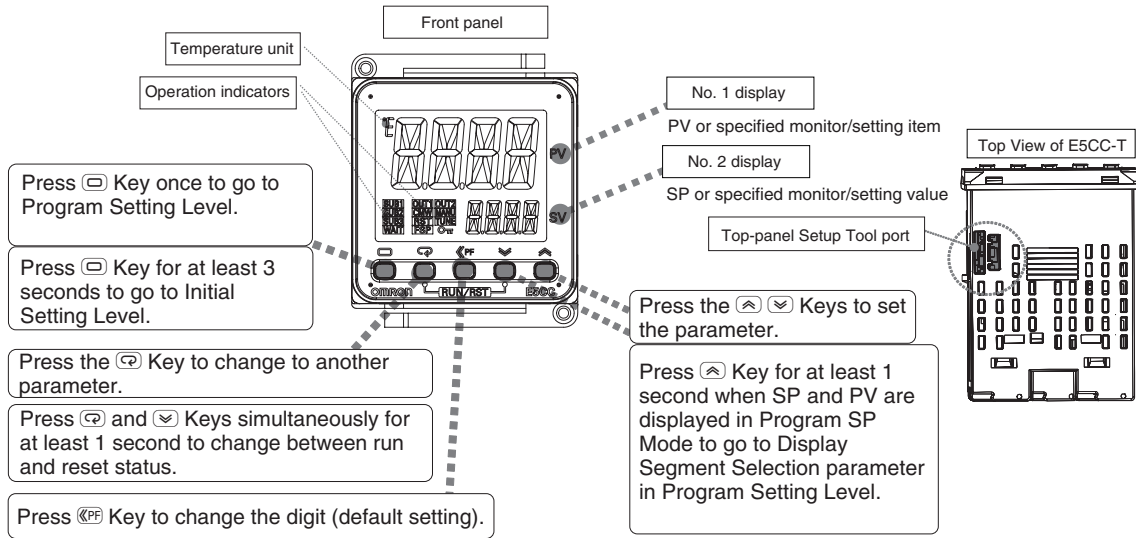

### E5EC-T

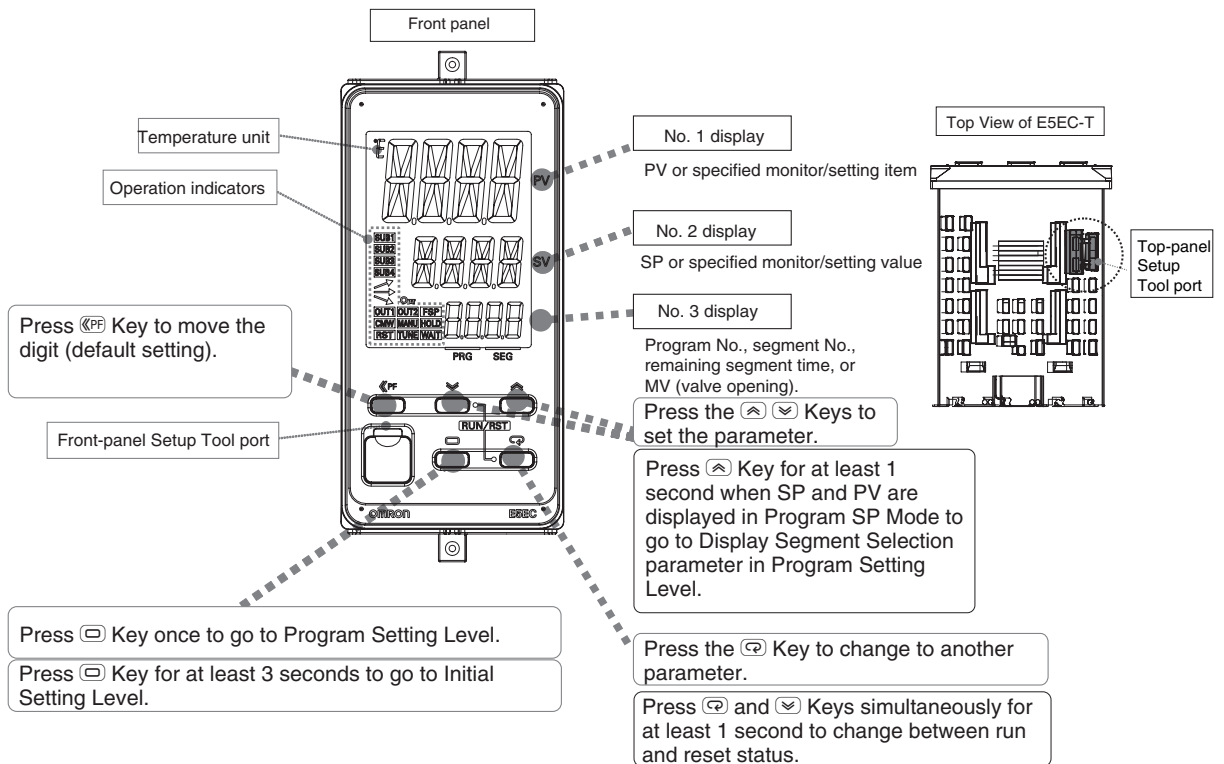

## E5AC-T

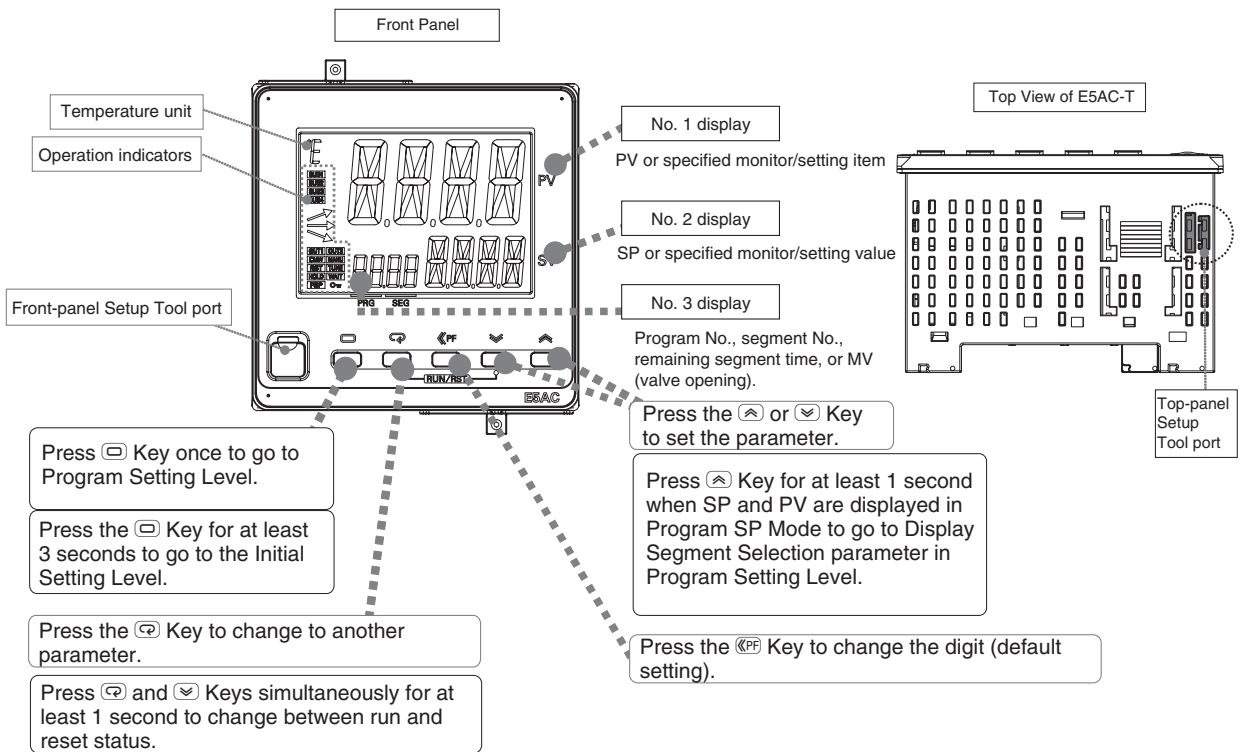

## Displays

Name	Description
No. 1 display	Displays the process value or a monitor/setting item.
No. 2 display	Displays the set point or the value of a monitor/setting item.
No. 3 Display (E5EC-T/E5AC-T only)	Displays the program number, segment number, remaining segment time, or MV (valve opening). (The value that is displayed is set in the PV/SP Display Selection parameter in the Advanced Function Setting Level.)
Temperature unit	Displays the temperature unit ( $^{\circ}\text{C}$ or $^{\circ}\text{F}$ ).

## Indicators



Operation indicators	Name	Description
<div style="border: 1px solid black; padding: 2px; display: inline-block;">SUB1</div> <div style="border: 1px solid black; padding: 2px; display: inline-block;">SUB2</div> <div style="border: 1px solid black; padding: 2px; display: inline-block;">SUB3</div> <div style="border: 1px solid black; padding: 2px; display: inline-block;">SUB4</div>	Auxiliary outputs 1 to 4 (auxiliary output 4: E5EC-T/E5AC-T only)	Each indicator lights when the function that is assigned to corresponding auxiliary output (1 to 4) is ON.
<div style="border: 1px solid black; padding: 2px; display: inline-block;">OUT1</div> <div style="border: 1px solid black; padding: 2px; display: inline-block;">OUT2</div>	Control outputs 1 and 2	Each indicator lights when the function that is assigned to corresponding control output (1 or 2) is ON. (For a linear current output, the indicator is not lit only for a 0% output.) For a Position-proportional Model, OUT1 lights when the open output is ON and OUT2 lights when the close output is ON.
	Program status indicators (E5EC-T/E5AC-T only)	The program status indicators show the direction of change of the present SP in the present segment. The indicators light as follows: Rising segment: top indicator, constant-temperature segment: middle indicator, and falling segment: bottom indicator.
<div style="border: 1px solid black; padding: 2px; display: inline-block;">CMW</div>	Communications writing	This indicator lights when wiring with communications is enabled.
<div style="border: 1px solid black; padding: 2px; display: inline-block;">MANU</div>	Manual	This indicator is lit in Manual Mode.
<div style="border: 1px solid black; padding: 2px; display: inline-block;">RST</div>	Reset	This indicator is lit while the program is being reset
<div style="border: 1px solid black; padding: 2px; display: inline-block;">TUNE</div>	AT in progress	This indicator is lit during autotuning.
<div style="border: 1px solid black; padding: 2px; display: inline-block;">FSP</div>	Fixed SP	This indicator is lit when the SP Mode is Fixed SP Mode while control is in progress.
<div style="border: 1px solid black; padding: 2px; display: inline-block;">HOLD</div>	Hold (E5EC-T/E5AC-T only)	This indicator is lit while the program is being held.
<div style="border: 1px solid black; padding: 2px; display: inline-block;">WAIT</div>	Wait	Lit while the program is in wait status.
	Setting change protection	This indicator is lit while setting change protection is ON.

## Keys

Key	Name	Overview	Description
	Level Key	<p>Selects the setting level.</p> <p>The next setting level depends on how long the key is pressed.</p>	<pre> graph TD     subgraph " "         OP[Operation Level] --&gt; PS[Program Setting Level]         PS --&gt; AD[Adjustment Level]         AD --&gt; PID[PID Setting Level]         PID --&gt; OP     end     PS --&gt; IS[Initial Setting Level]     IS --&gt; CS[Communications Setting Level]     CS --&gt; IS     IS --&gt; OP     </pre> <p>Press  for less than 1 s.</p> <p>Press  for at least 3 s in any setting level.</p> <p>Press  for at least 1 s.</p> <p>Press  for less than 1 s.</p>





Key	Name	Overview	Description
	Mode Key	Changes the parameter that is displayed within a setting level.	<ul style="list-style-type: none"> <li>Press once to go to the next parameter.</li> <li>Hold to go to the previous parameter.</li> </ul>
 	Down Key and Up Key	Set the value.	<ul style="list-style-type: none"> <li>Hold the key to increment or decrement the value quickly.</li> <li>Any changes in settings are applied at the following times:                             <ul style="list-style-type: none"> <li>After 3 seconds elapse</li> <li>When the  Key is pressed</li> <li>When the level is changed with the  Key</li> </ul> </li> </ul>
	Up Key	Moves to the segment setting parameter (Display Segment Selection) for the currently selected program.	<p>Operation Level</p> <p>Press  Key for at least 1 s in Program SP Mode.</p> <ul style="list-style-type: none"> <li>If you press the  Key for at least 1 second when SP and PV are displayed in Program SP Mode, you will go to segment number currently used in control.</li> <li>To return to the Operation Level, press the  Key 3 times for less than 1 second each.</li> </ul>
+	Run/Reset Keys	Changes program between run and reset status	<ul style="list-style-type: none"> <li>Press the  and  Keys simultaneously for at least 1 second to change between run and reset status.</li> </ul>
	Shift Key (PF Key)	Operates as a user-defined function key.	<ul style="list-style-type: none"> <li>Press the  Key for less than 1 second to select the digit to change. The digit changes by one digit every time you press the key (default setting).</li> <li>You can change the PF Setting parameter in the Advanced Setting Level to assign any of the following functions to the  Key. Run/reset, advance, hold, auto/manual, autotune, cancel alarm latch, display monitor/setting item, or digit shift (default) Example: If you set the PF Setting parameter in the Advanced Setting Level to RST, operation will be reset when you press the  Key for at least 1 second.</li> <li>If you set PFDF (monitor/setting items), each time you press the  Key for less than 1 second, the display is changed in order for the items that are set for the Monitor/Setting Item 1 to 5 parameters.</li> </ul>

## Setup Tool Ports

Setup Tool port	Name	Description
	Top-panel Setup Tool port	Use the E58-CIFQ2 USB-Serial Conversion Cable to connect the E5□C to the computer (i.e., the CX-Thermo Support Software).
	Front-panel Setup Tool port (E5EC-T/E5AC-T only)	Use the E58-CIFQ2 USB-Serial Conversion Cable and the E58-CIFQ2-E Conversion Cable to connect the E5EC-T/E5AC-T to the computer (i.e., the CX-Thermo Support Software).

### 3-3-2 Entering Numeric Values



#### Applying Changes to Numeric Values

After you change a numeric value with the   Keys, the changes are applied 1) when 3 seconds elapses, 2) when the  Key is pressed, or 3) when the level is changed with the  Key.



#### Precautions for Correct Use



Always make sure that any changes to numeric values are applied for one of the three methods that are given above before you turn OFF the power supply to the E5□C-T.

If you only change the values with the   Keys and turn OFF the power supply before 3 seconds has elapsed, the changes will not be applied.

#### Moving between Digits (Digit Shift Key)

Press the Shift Key (PF Key) to select the digit to change.

This is useful when entering a numeric value with many digits.

Use this key to change levels: The digit to change will move as follows: 1s digit, 10s digit, 100s digit, 1000s digit, and then back to the 1s digit. Press the  +  Keys to change the value of a digit.

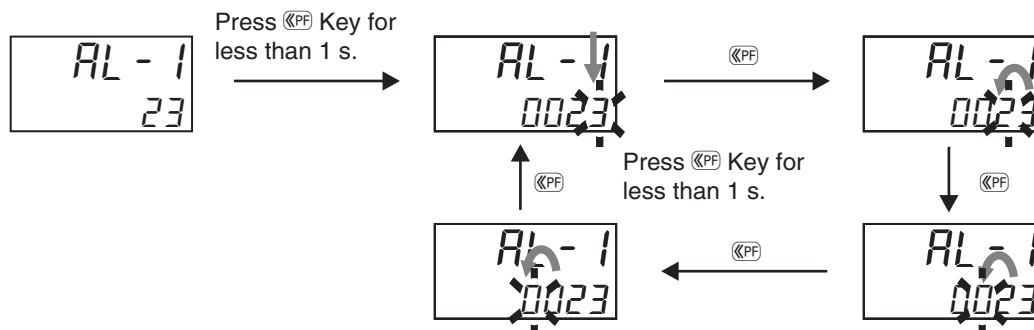



### 3-3-3 Setting Levels

On the E5□C-T, the parameters are classified into levels according to their applications. These levels are called setting levels. The setting levels consist of some basic setting levels and other setting levels.

#### Moving between Setting Levels

The following figure gives an overall image of the setting levels. The setting levels consist of the basic setting levels (shaded below) and the other setting levels (not shaded).

The Initial Setting Level, Communications Setting Level, Advanced Function Setting Level, and Calibration Level can be used only when control is stopped. If you change to any of these levels, control will stop.

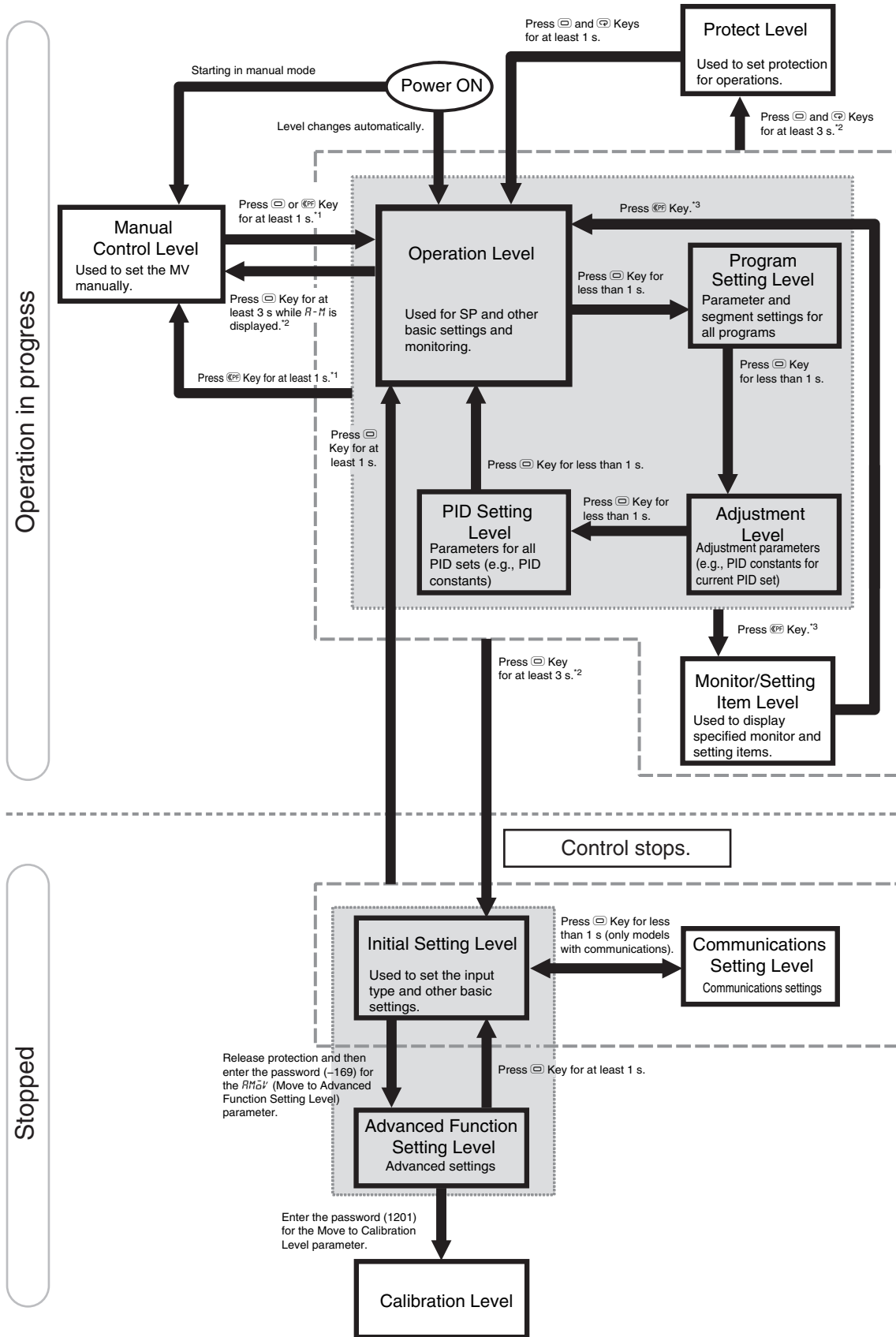

\*1 Set the PF Setting parameter to *R-M* (Auto/Manual).  
 \*2 The No. 1 display will flash when the keys are pressed for 1 s or longer.  
 \*3 Set the PF Setting parameter to *PFdP* (monitor/setting items).

## Basic Setting Levels

---

### ● Operation Level

This level is displayed automatically when the power supply is turned ON.

This level is used for the SP and other basic settings and monitoring.

Normally, select this level for operation.

### ● Program Setting Level

This level is used to set the parameters for the programs (SPs, rates of rise, times, etc.).

### ● Adjustment Level

This level is used to set the PID constants and to perform tuning, such as autotuning.

### ● PID Setting Level

This level is used to set the parameters for the PID sets (PID constants, MVs, upper/lower limits, manual reset values, PID set automatic selection range upper limits, etc.).

### ● Initial Setting Level

This level is used for the most basic settings.

It is used to set the input type and other parameters.

Use it to set the input type, alarm type, and other basic settings.

\* You can use this level only when control is stopped.

### ● Advanced Function Setting Level

This level is used for advanced settings.

Use it to assign functions to the control outputs and auxiliary outputs.

You will not be able to enter the Advanced Function Setting Level with the default settings.

To enter the Advanced Function Setting Level, first disable Initial Setting/Communications Protection and then enter the password (-169) at the  $\overline{M\overline{A}V}$  (Move to Advanced Function Setting Level) parameter in the Initial Setting Level.

\* You can use this level only when control is stopped.

Use the following procedure to move to Advanced Function Setting Level.

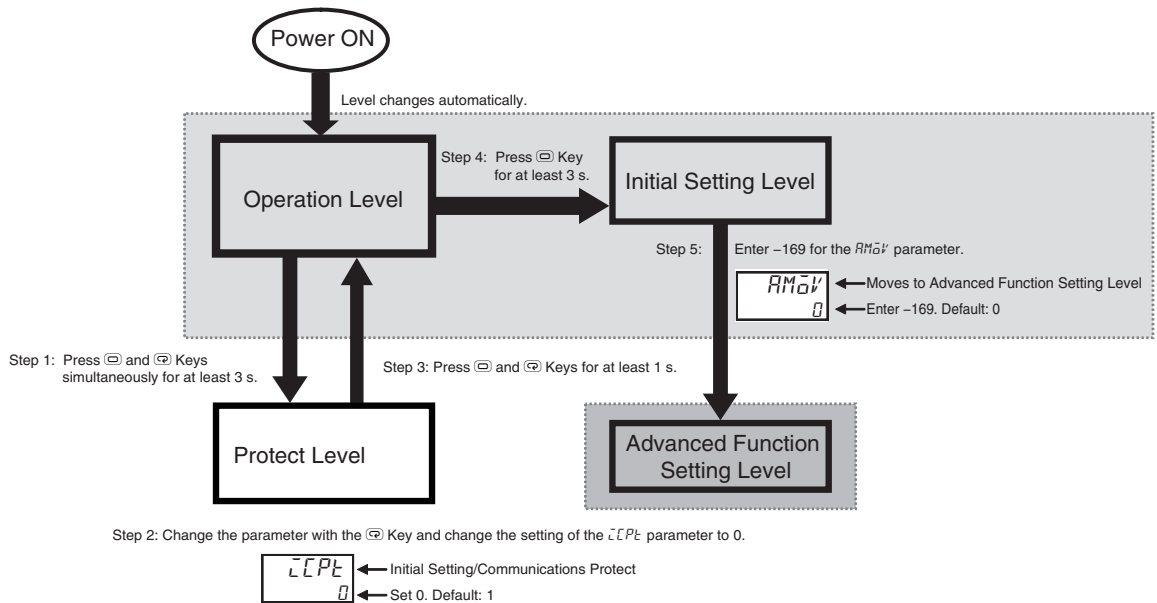

- Step 1: Move to Protect Level.
- Step 2: Display  $\text{LCPt}$  (Initial Setting/Communications Protect) and set it to 0.
- Step 3: Return to Operation Level.
- Step 4: Return to Initial Setting Level.
- Step 5: Display  $\text{AMOV}$  (Move to Advanced Function Setting Level) and then enter -169.
- Steps 1 to 3 are necessary only the first time. Perform only steps 4 and 5 to move to Advanced Function Setting Level.

## Other Setting Levels

There are five other setting levels: Manual Control Level, Protect Level, Communications Setting Level, Calibration Level, and Monitor/Setting Item Level.

### ● Manual Control Level

This level is used to set the MV manually.

- To move from the Operation Level to the Manual Control Level, press the  $\text{Home}$  Key for at least 3 seconds while the Auto/Manual Switch parameter is displayed.
- To use the  $\text{PF}$  Key to move to the Manual Control Level, change the setting of the PF Setting parameter to  $\text{R-M}$ .
- To use an event input to move to the Manual Control Level, change the setting of the Event Input Assignment 1 to 6 parameter to  $\text{MANU}$ .

### ● Protect Level

This level is used to restrict the operations that can be performed and the parameters that can be displayed with the front-panel keys. For example, you can prohibit changing the SP and other parameters in the Operation Level, Program Setting Level, Adjustment Level, and PID Setting Level. You can move to this level from the Operation Level, Program Setting Level, Adjustment Level, or PID Setting Level. To move to the Advanced Function Setting Level, you must first cancel the protection that is set in the Protect Level.

### ● Communications Setting Level

This level is used to set the communications parameters. You can move to the Communications Setting Level from the Initial Setting Level.

- \* You can use this level only when control is stopped.

- **Calibration Level**

This level is used to calibrate the Digital Controller. You can move to the Calibration Level from the Advanced Function Setting Level.

\* You can use this level only when control is stopped.

- **Monitor/Setting Item Level**

To use the  Key to display the Monitor/Setting Items, change the setting of the PF Setting parameter to *PFdP*. The items that will be displayed in the Monitor/Setting Item Level are set using the Monitor/Setting Item 1 to 5 parameters.

## 3-4 Procedures after Turning ON the Power Supply

---

### 3-4-1 Basic Flow of Operations

The basic flow of operations after you turn ON the power supply is shown below.

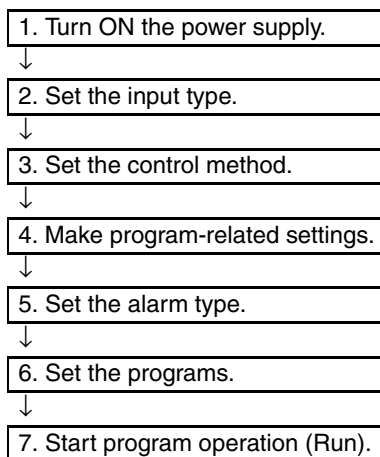

### 3-4-2 Basic Procedure

The basic procedure is given below.

#### 1 Turn ON the power supply.

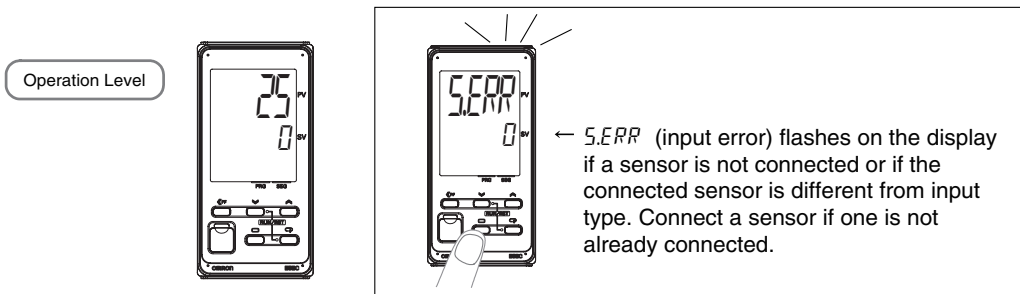

#### 2 Set the input type.

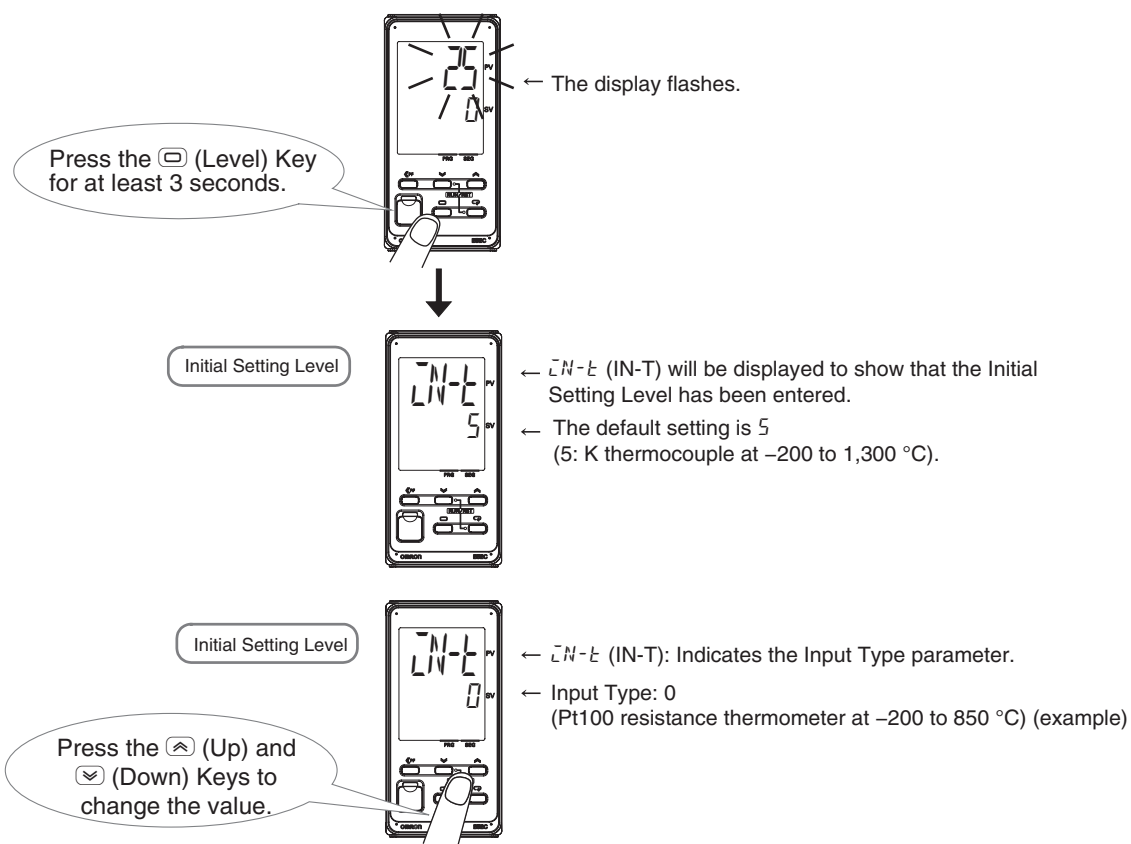

When you are finished, press the [Level] Key for at least 1 second to return to the operation display.

## List of Input Types

Input type	Specifications	Set value	Temperature range in °C	Temperature range in °F
Resistance thermometer	Pt100	0	-200 to 850	-300 to 1500
		1	-199.9 to 500.0	-199.9 to 900.0
		2	0.0 to 100.0	0.0 to 210.0
	JPt100	3	-199.9 to 500.0	-199.9 to 900.0
4		0.0 to 100.0	0.0 to 210.0	
Thermocouple	K	5*	-200 to 1300	-300 to 2300
		6	-20.0 to 500.0	0.0 to 900.0
	J	7	-100 to 850	-100 to 1500
		8	-20.0 to 400.0	0.0 to 750.0
	T	9	-200 to 400	-300 to 700
		10	-199.9 to 400.0	-199.9 to 700.0
	E	11	-200 to 600	-300 to 1100
	L	12	-100 to 850	-100 to 1500
	U	13	-200 to 400	-300 to 700
		14	-199.9 to 400.0	-199.9 to 700.0
	N	15	-200 to 1300	-300 to 2300
	R	16	0 to 1700	0 to 3000
	S	17	0 to 1700	0 to 3000
	B	18	100 to 1800	300 to 3200
W	19	0 to 2300	0 to 3200	
PLII	20	0 to 1300	0 to 2300	
Infrared temperature sensor ES1B	10 to 70°C	21	0 to 90	0 to 190
	60 to 120°C	22	0 to 120	0 to 240
	115 to 165°C	23	0 to 165	0 to 320
	140 to 260°C	24	0 to 260	0 to 500
Current input	4 to 20 mA	25	One of the following ranges according to the scaling: -1999 to 9999	
	0 to 20 mA	26		
Voltage input	1 to 5 V	27	-199.9 to 999.9 -19.99 to 99.99 -1.999 to 9.999	
	0 to 5 V	28		
	0 to 10 V	29		

\* The default is 5.



### 3 Set the control method.

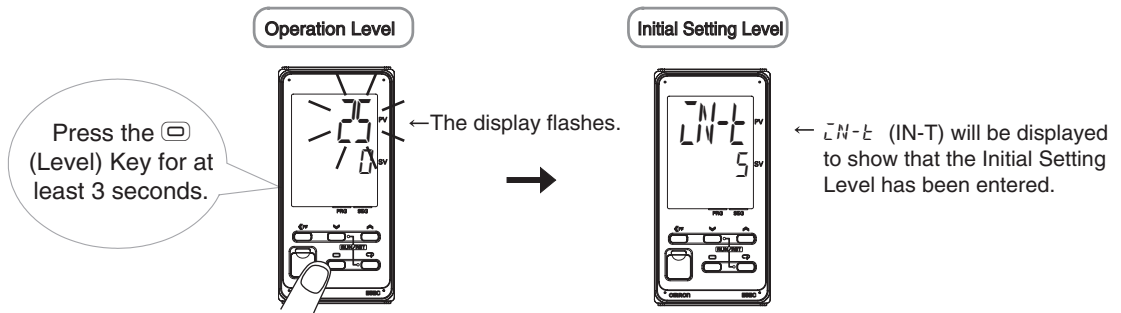

#### Standard Models

##### PID Control

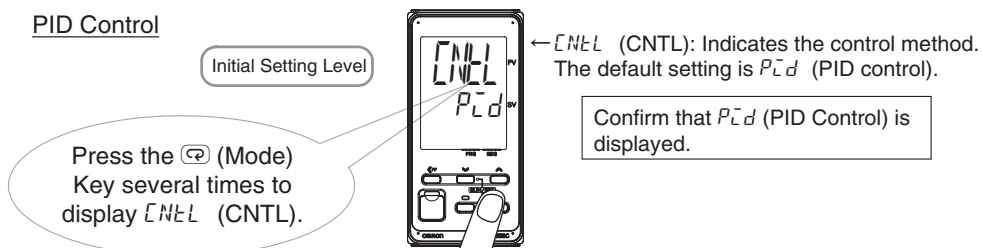

#### Position-proportional Models

##### Close/Floating Control

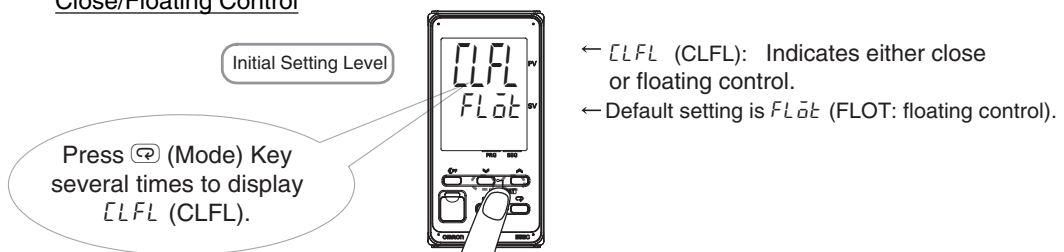

### 4 Make the initial program-related settings.



- Program Time Unit (T-U)
- Step Time/Rate of Rise Programming (T-PR)
- Reset Operation (RESM)
- Operation End Operation (ESEt)
- Startup Operation (P-āN)

Refer to Section 4 Basic Operation for the setting procedures.

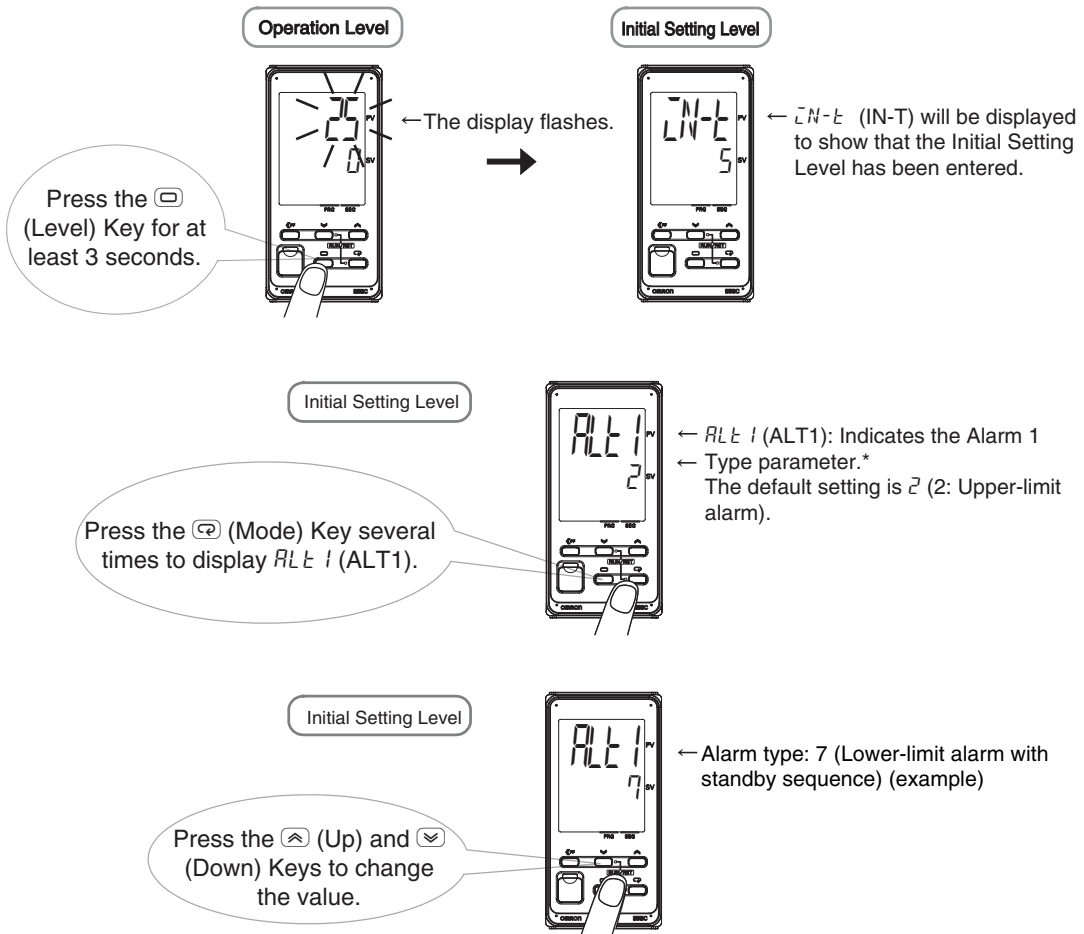
## 5 Set the alarm type.



\* If the Controller is equipped with HB/HS alarm detection, the Alarm 1 Type is not displayed for the default settings. To use alarm 1, set an output assignment to alarm 1. For details, refer to *4-6-3 Assigned Output Functions (Assigning Control Outputs Is Not Supported for Position-proportional Models.)*.

If required, use the  (Mode) Key and the  (Up) and  (Down) Keys to repeat the procedure to set alarm types for **AL2** (AL2) (Alarm 2 Type), **AL3** (AL3) (Alarm 3 Type), and **AL4** (AL4) (Alarm 4 Type). (The number of alarms that is supported depends on the model of Digital Controller. Some of the alarm parameters may not be displayed.)

When you are finished, press the  (Level) Key for at least 1 second to return to the operation display.

## Alarm Type Numbers

Alarm type No.	Alarm type	Description	Operation
0	Alarm function OFF	There will be no alarm outputs.	---
1	Upper- and lower-limit alarm	The alarm output is ON while the PV is equal to or higher than the upper-limit alarm point or while the PV is equal to or lower than the lower-limit alarm point.	Example: 
2	Upper-limit alarm	The alarm output is ON while the PV is equal to or higher than the upper-limit alarm point.	Example: 
3	Lower-limit alarm	The alarm output is ON while the PV is equal to or lower than the lower-limit alarm point.	Example: 
4	Upper- and lower-limit range alarm	The alarm output is ON while the PV is equal to or lower than the upper-limit alarm point or equal to or higher than the lower-limit alarm point.	Example: 
5	Upper- and lower-limit alarm with standby sequence	This alarm provides a standby sequence. The alarm output is ON while the PV is equal to or higher than the upper-limit alarm point or while the PV is equal to or lower than the lower-limit alarm point.	Example: 
6	Upper-limit alarm with standby sequence	This alarm provides a standby sequence. The alarm output is ON while the PV is equal to or higher than the upper-limit alarm point.	Example: 
7	Lower-limit alarm with standby sequence	This alarm provides a standby sequence. The alarm output is ON while the PV is equal to or lower than the lower-limit alarm point.	Example: 

Alarm type No.	Alarm type	Description	Operation
8	Absolute-value upper-limit alarm	The alarm output is ON while the PV is equal to or higher than the alarm value.	<p>Example:</p>
9	Absolute-value lower-limit alarm	The alarm output is ON while the PV is equal to or lower than the alarm value.	<p>Example:</p>
10	Absolute-value upper-limit alarm with standby sequence	This alarm provides a standby sequence. The alarm output is ON while the PV is equal to or higher than the alarm value.	<p>Example:</p>
11	Absolute-value lower-limit alarm with standby sequence	This alarm provides a standby sequence. The alarm output is ON while the PV is equal to or lower than the alarm value.	<p>Example:</p>
12	Loop Burnout Alarm (LBA) (Valid only for alarm 1 on a Standard Model.)	The alarm output turns ON when the control loop is broken.	<p>There is assumed to be a loop burnout alarm if the control deviation (<math>SP - PV</math>) is greater than the threshold set in the LBA Level parameter and if the PV is not reduced by at least the value set in the LBA Band parameter within a specific period of time. The LBA detection time and LBA band are set in parameters.</p>

Alarm type No.	Alarm type	Description	Operation
13	PV change rate alarm	The alarm output turns ON if the change in the PV within the specified calculation period exceeds a specific width.	<p>PV</p> <p>PV Change Rate Alarm Output</p> <p>ON</p> <p>OFF</p> <p>The PV rate of change calculation period and the alarm value are set in parameters.</p>
14	SP absolute-value upper-limit alarm	The alarm output is ON while the SP is equal to or higher than the alarm value.	<p>Example:</p> <p>ON</p> <p>OFF</p> <p>0</p> <p>Upper-limit alarm point (e.g., 100°C)</p> <p>Alarm value (e.g., 100°C)</p>
15	SP absolute-value lower-limit alarm	The alarm output is ON while the SP is equal to or lower than the alarm value.	<p>Example:</p> <p>ON</p> <p>OFF</p> <p>0</p> <p>Lower-limit alarm point (e.g., 100°C)</p> <p>Alarm value (e.g., 100°C)</p>
16	MV absolute-value upper-limit alarm	The alarm output is ON while the MV is equal to or higher than the alarm value.	<p>Example for Standard Control:</p> <p>ON</p> <p>OFF</p> <p>0</p> <p>Upper-limit alarm point (e.g., 60%)</p> <p>Alarm value (e.g., 60%)</p>
17	MV absolute-value lower-limit alarm	The alarm output is ON while the MV is equal to or lower than the alarm value.	<p>Example for Standard Control:</p> <p>ON</p> <p>OFF</p> <p>0</p> <p>Lower-limit alarm point (e.g., 80%)</p> <p>Alarm value (e.g., 80%)</p>

## 6 Set the programs.

Set the programs, parameters (including the alarm values), and segments.

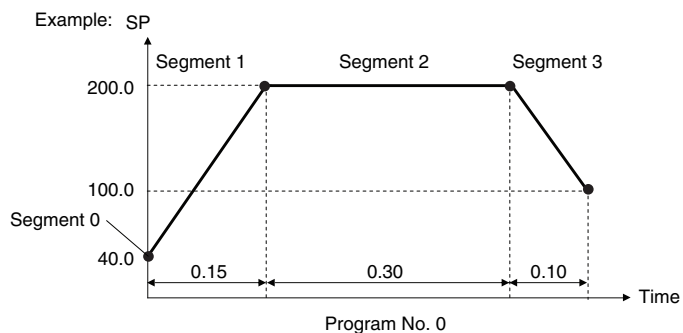

Number of Segments Used: 4

Step Time/Rate of Rise Programming: Step time programming

Segment No.	0	1	2	3
Segment SP	40.0	200.0	2000.0	100.0
Segment Time (hours, minutes)	0.00	0.15	0.30	0.10

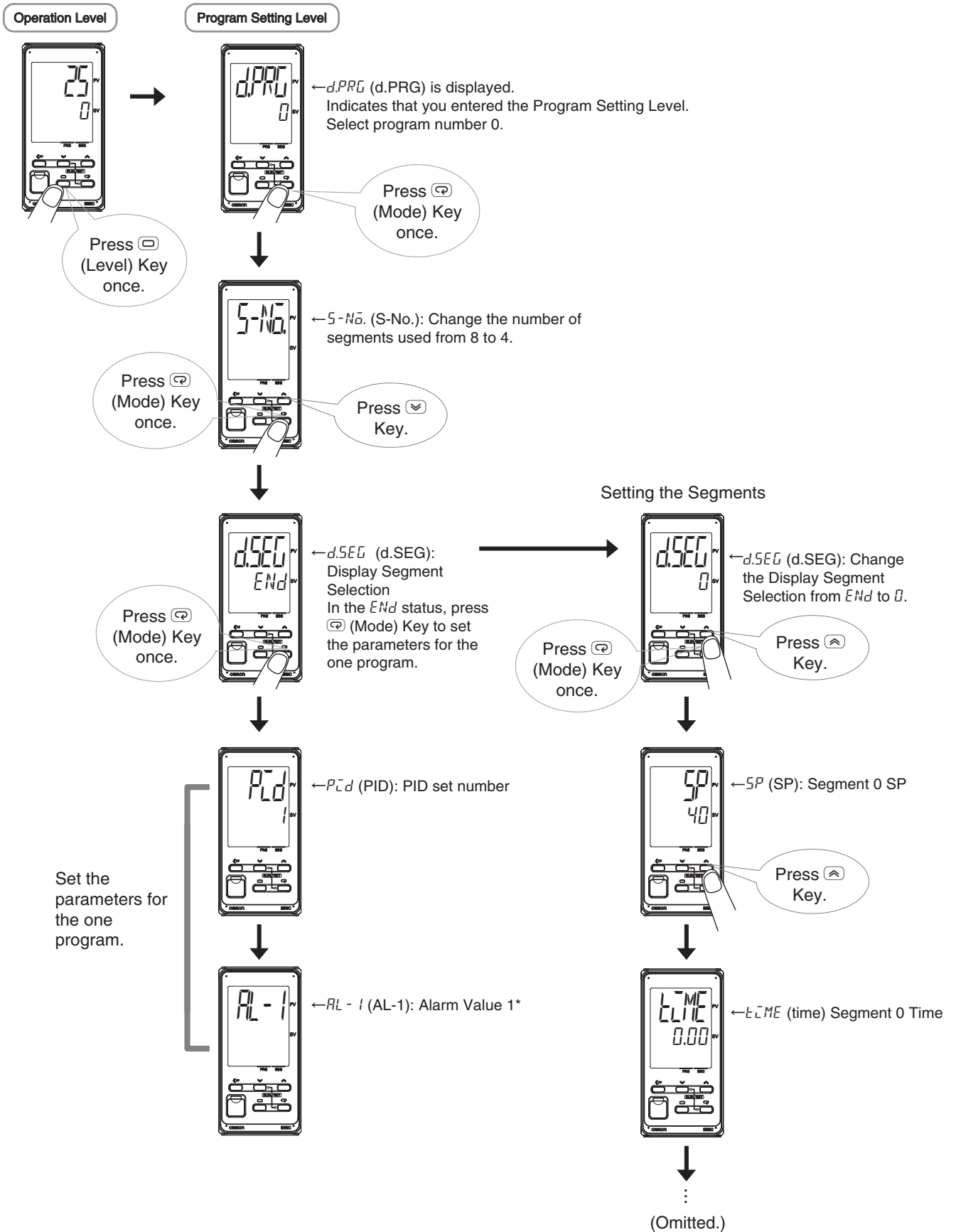

\* In the default settings for models with HB or HS alarms, the Alarm Type 1 parameter is not displayed. To enable alarm 1, assign it to an output. Refer to 4-6-3 Assigned Output Functions (Assigning Control Outputs Is Not Supported for Position-proportional Models.) for details.

## 7 Start program operation (run).

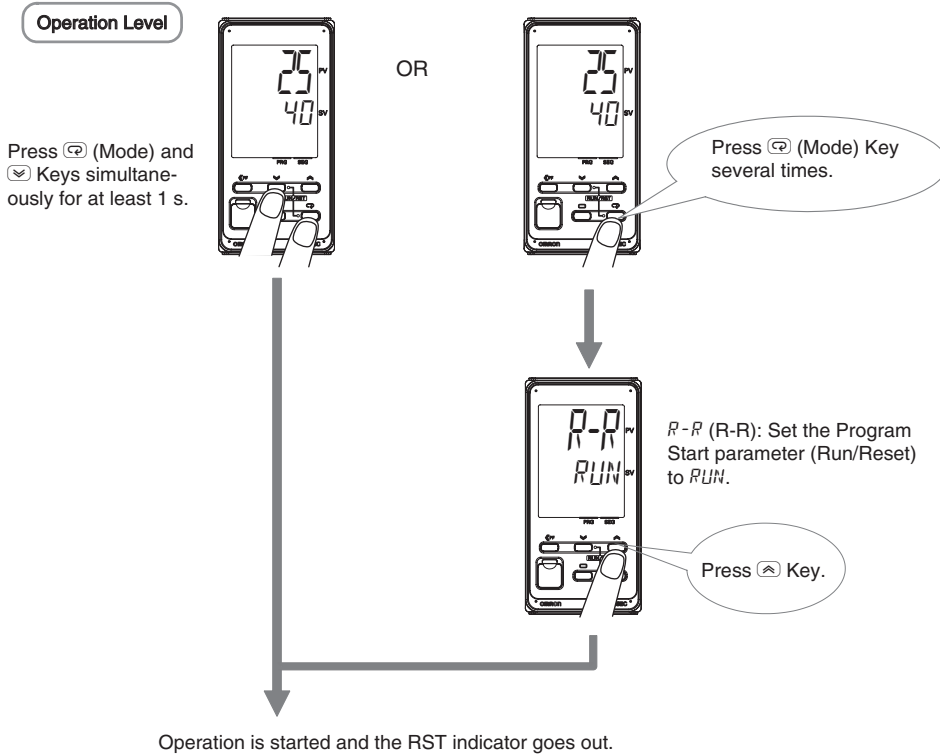

Here, you can set the input type, alarm type, control method, programs, and alarm set values. Refer to *Section 4 Basic Operation* and *Section 5 Advanced Operations* for individual settings, such as the PID constant settings and HB/HS alarms.



# 4

## Basic Operation

<b>4-1</b>	<b>Moving between Setting Levels</b>	<b>4-3</b>
4-1-1	Moving to the Initial Setting Level	4-3
4-1-2	Moving to the Program Setting Level	4-4
4-1-3	Moving to the Adjustment Level	4-5
4-1-4	Moving to the PID Setting Level	4-5
4-1-5	Moving to the Protect Level	4-6
4-1-6	Moving to the Advanced Function Setting Level	4-7
4-1-7	Moving to the Communications Setting Level	4-9
<b>4-2</b>	<b>Initial Setup Examples through Starting Program Operation</b>	<b>4-10</b>
4-2-1	Program Operation	4-10
4-2-2	Initial Setup Example for Step Time Programming	4-11
4-2-3	Initial Setup Example for Rate of Rise Programming	4-14
<b>4-3</b>	<b>Setting the Input Type</b>	<b>4-18</b>
4-3-1	Input Type	4-18
<b>4-4</b>	<b>Selecting the Temperature Unit</b>	<b>4-20</b>
4-4-1	Temperature Unit	4-20
<b>4-5</b>	<b>Selecting PID Control or ON/OFF Control (Not Supported for Position-proportional Models.)</b>	<b>4-21</b>
<b>4-6</b>	<b>Setting Output Specifications</b>	<b>4-22</b>
4-6-1	Control Periods (Not Supported for Position-proportional Models.)	4-22
4-6-2	Direct and Reverse Operation	4-22
4-6-3	Assigned Output Functions (Assigning Control Outputs Is Not Supported for Position-proportional Models.)	4-23
4-6-4	Auxiliary Output Opening or Closing in Alarm	4-26
<b>4-7</b>	<b>Setting Programs</b>	<b>4-27</b>
4-7-1	Programming	4-27
4-7-2	Program Patterns	4-30
4-7-3	Setting Flow for Program-related Settings	4-32
4-7-4	Making the Initial Program-related Settings	4-33
4-7-5	Creating the Program	4-39
4-7-6	Changing Programs during Operation	4-45
<b>4-8</b>	<b>Setting the Fixed SP</b>	<b>4-47</b>
4-8-1	Fixed SP Setting Methods	4-47

<b>4-9 Determining PID Constants (Autotuning and Manual Setting)</b>	<b>4-49</b>
4-9-1 AT (Auto-tuning)	4-50
4-9-2 RT (Robust Tuning) (Used for Autotuning)	4-52
4-9-3 Manual Setup	4-54
<b>4-10 Alarm Outputs</b>	<b>4-56</b>
4-10-1 Alarm Types	4-56
4-10-2 Alarm Values	4-59
<b>4-11 Alarm Hysteresis</b>	<b>4-62</b>
4-11-1 Standby Sequence	4-62
4-11-2 Alarm Latch	4-63
<b>4-12 Using Heater Burnout (HB) and Heater Short (HS) Alarms (Not Supported for Position-proportional Models.)</b>	<b>4-64</b>
4-12-1 HB Alarm	4-64
4-12-2 HS Alarm	4-66
4-12-3 Installing Current Transformers (CT)	4-68
4-12-4 Calculating Detection Current Values	4-70
4-12-5 Application Examples	4-70
<b>4-13 Using ON/OFF Control (Not Supported for Position-proportional Models.)</b>	<b>4-74</b>
4-13-1 ON/OFF Control	4-74
4-13-2 Settings	4-75
<b>4-14 Customizing the PV/SP Display</b>	<b>4-76</b>
4-14-1 PV/SP Display Selections	4-76

## 4-1 Moving between Setting Levels

The Operation Level is displayed first when the power supply to the Digital Controller is turned ON. To display the parameters, you must move to the following setting levels.

- Operation Level (Entered when the power supply is turned ON.)
- Initial Setting Level
- Program Setting Level
- Adjustment Level
- PID Setting Level
- Protect Level
- Advanced Function Setting Level
- Communications Setting Level

The procedures to move between the setting levels starting from the Operation Level are provided below.

### 4-1-1 Moving to the Initial Setting Level

#### Moving from the Operation Level to the Initial Setting Level

**1** Press the  Key for at least 3 seconds in the Operation Level.

The No. 1 display will flash when the key is pressed for 1 s or longer.

The display will change from the Operation Level to the Initial Setting Level.

Operation Level

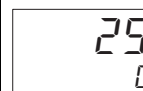

Initial Setting Level

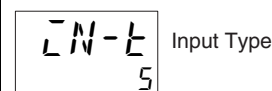

#### Moving from the Initial Setting Level to the Operation Level

**1** Press the  Key for at least 1 second in the Initial Setting Level.

The display will change from the Initial Setting Level to the Operation Level.

Initial Setting Level

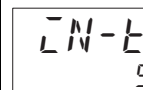

Operation Level

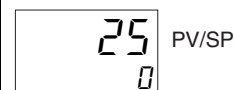

## 4-1-2 Moving to the Program Setting Level

### Moving from the Operation Level to the Program Setting Level

- 1 Press the  Key for less than 1 second in the Operation Level.

The display will change to the Program Setting Level and the Display Program Selection parameter will be displayed.

Operation Level

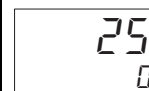

Program Setting Level

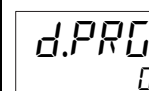

Display Program Selection

### Moving from the Program Setting Level to the Operation Level

- 1 Press the  Key three times for less than 1 second each time in the Program Setting Level.

The display will change from the Program Setting Level to the Operation Level.

Program Setting Level

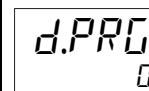

Operation Level

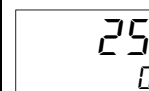

Process Value/  
Set Point 1/2

### Moving from the Operation Level to the Display Segment Selection Parameter in the Program Setting Level

With the E5□C-T, you can use the  Key to move to the parameters for the current segment. Use the following procedure.

- 1 Select the Process Value/Set Point 1 or Process Value/Set Point 2 parameter in the Operation Level.

- 2 Press the Up Key for at least 1 second.

The display will change to the Program Setting Level and the Display Segment Selection parameter will be displayed.

\* You must be in Program SP Mode to make this move.

Operation Level

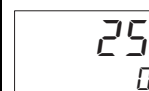

Program Setting Level

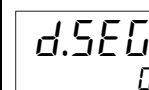

Display Segment Selection

### 4-1-3 Moving to the Adjustment Level

#### Moving from the Operation Level to the Adjustment Level

- 1** Press the  Key twice for less than 1 second each time in the Operation Level.

The display will change from the Operation Level to the Adjustment Level.

\* *L.Adj* will be displayed only once when you move to the Adjustment Level.

Operation Level

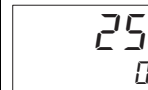

Adjustment Level

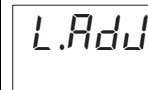

#### Moving from the Adjustment Level to the Operation Level

- 1** Press the  Key twice for less than 1 second each time in the Adjustment Level.

The display will change from the Adjustment Level to the Operation Level.

Adjustment Level

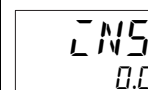

Process Value  
Input Shift

Operation Level

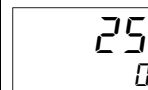

PV/SP

### 4-1-4 Moving to the PID Setting Level

#### Moving from the Operation Level to the PID Setting Level

- 1** Press the  Key three times for less than 1 second each time in the Operation Level.

The display will move to the PID Setting Level and the Display PID Selection parameter will be displayed.

Operation Level

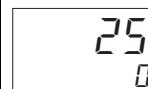

PID Setting Level

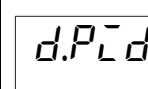

Display PID  
Selection

#### Moving from the PID Setting Level to the Operation Level

- 1** Press the  Key for less than 1 second in the PID Setting Level.

The display will change from the PID Setting Level to the Operation Level.

PID Setting Level

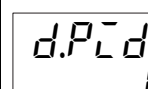

Operation Level

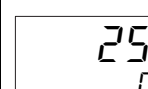

Process Value/  
Set Point 1/2

## 4-1-5 Moving to the Protect Level

## Moving from the Operation Level to the Protect Level

- 1** Press the  and  Keys simultaneously for at least 3 seconds\* in the Operation Level.

The No. 1 display will flash when the keys are pressed for 1 s or longer.

\* The key pressing time can be changed in the Move to Protect Level Time parameter in the Advanced Function Setting Level.

The display will change to the Protect Level.

Operation Level

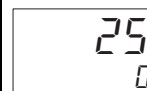

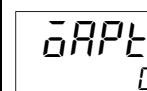

Protect Level



Operation/  
Adjustment  
Protect

## Moving from the Protect Level to the Operation Level

- 1** Press the  and  Keys simultaneously for at least 1 second in the Protect Level.

The display will change from the Protect Level to the Operation Level.

Protect Level

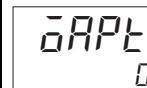

Operation Level

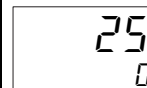



PV/SP

## 4-1-6 Moving to the Advanced Function Setting Level

### Moving to the Advanced Function Setting Level for the First Time (i.e., with the Default Settings)

To enter the Advanced Function Setting Level, you must first enter the Protect Level and change the setting of the  $\overline{\text{ICP}}\text{L}$  (Initial Setting/Communications Protect) parameter to 0 (enable moving to Advanced Function Setting Level) to clear the protection.

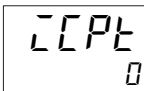
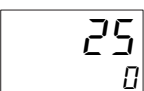

#### ● Clearing Protection

<p><b>1</b> Press the <math>\text{⏏}</math> and <math>\text{⏏}</math> Keys simultaneously for at least 3 seconds* in the Operation Level.</p> <p>The No. 1 display will flash when the key is pressed for 1 s or longer.</p> <p>* The key pressing time can be changed in the Move to Protect Level Time parameter in the Advanced Function Setting Level.</p> <p>The display will change to the Protect Level.</p>	<p>Operation Level</p> 
<p><b>2</b> Press the <math>\text{⏏}</math> Key once at the Operation/Adjustment Protect parameter.</p> <p>The display will change to the Initial Setting/Communications Protect parameter.</p>	<p>Protect Level</p>  <p>Operation/Adjustment Protect</p>
<p><b>3</b> Press the <math>\text{⏏}</math> or <math>\text{⏏}</math> Key at the Initial Setting/Communications Protect parameter to change the set value to 0 (enable moving to Advanced Function Setting Level).</p> <p>Now the <math>\overline{\text{AMOV}}</math> (Move to Advanced Function Setting Level) parameter can be displayed in the Initial Setting Level.</p> <p>The default is 1 (disable moving to Advanced Function Setting Level).</p>	<p><math>\overline{\text{ICP}}\text{L}</math></p> <p>Initial Setting/Communications Protect</p> <p>1: Moving to Advanced Function Setting Level is disabled.</p>
<p><b>4</b> Press the <math>\text{⏏}</math> and <math>\text{⏏}</math> Keys simultaneously for at least 1 second in the Protect Level.</p> <p>The display will change from the Protect Level to the Operation Level.</p>	<p>Protect Level</p>  <p>Initial Setting/Communications Protect</p> <p>Operation Level</p>  <p>PV/SP</p>

## Moving to the Advanced Function Setting Level after Clearing Protection

After you have set the  $\overline{CPL}$  (Initial Setting/Communications Protect) parameter to  $\overline{0}$  (enable moving to Advanced Function Setting Level), select  $AM\overline{OV}$  (Move to Advanced Function Setting Level) in the Initial Setting Level.

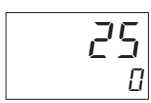
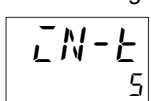
### ● Moving to the Advanced Function Setting Level

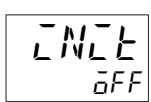
<p><b>1</b> Press the <math>\overline{\text{ON}}</math> Key for at least 3 seconds in the Operation Level. The No. 1 display will flash when the key is pressed for 1 s or longer. The display will change from the Operation Level to the Initial Setting Level.</p>	<p>Operation Level</p> 
<p><b>2</b> Press the <math>\overline{\text{CN}}</math> Key several times in the Initial Setting Level to display <math>AM\overline{OV}</math> (Move to Advanced Function Setting Level).</p>	<p>Initial Setting Level</p>  <p>Input Type</p>
<p><b>3</b> Press the <math>\overline{\text{DN}}</math> and <math>\overline{\text{UP}}</math> Keys at the Move to Advanced Function Setting Level parameter and then enter -169. * You can hold the <math>\overline{\text{UP}}</math> (Up) or <math>\overline{\text{DN}}</math> (Down) Key to increment or decrement the set value quickly.</p>	<p>Initial Setting Level</p>  <p>Move to Advanced Function Setting Level</p>
<p><b>4</b> Press <math>\overline{\text{CN}}</math> Key once or wait for 2 seconds or longer without doing anything.  The display will change to the Advanced Function Setting Level.</p>	<p> Move to Advanced Function Setting Level -169: Password to move to Advanced Function Setting Level</p> <p>Advanced Function Setting Level</p>  Parameter Initialization

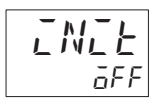
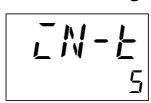
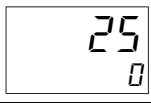

### ● Moving from the Advanced Function Setting Level to the Operation Level

<p><b>1</b> Press the <math>\overline{\text{ON}}</math> Key for at least 1 second in the Advanced Function Setting Level. The display will change from the Advanced Function Setting Level to the Initial Setting Level.</p>	<p>Advanced Function Setting Level</p> 
<p><b>2</b> Press the <math>\overline{\text{ON}}</math> Key for at least 1 second in the Initial Setting Level.  The display will change from the Initial Setting Level to the Operation Level.</p>	<p>Initial Setting Level</p>  <p>Input Type</p> <p>Operation Level</p>  <p>PV/SP</p>



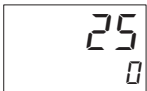

## 4-1-7 Moving to the Communications Setting Level

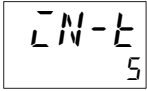
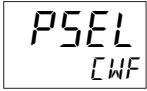
### ● Moving from the Operation Level to the Communications Setting Level

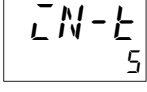
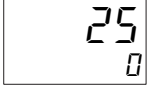

<p><b>1</b> Press the  Key for at least 3 seconds in the Operation Level. The No. 1 display will flash when the keys are pressed for 1 s or longer. The display will change from the Operation Level to the Initial Setting Level.</p>	<p>Operation Level</p> 
<p><b>2</b> Press the  Key for less than 1 second in the Initial Setting Level.</p> <p>The display will change from the Initial Setting Level to the Communications Setting Level.</p>	<p>Initial Setting Level</p>  Input Type <p>Communications Setting Level</p>  Protocol Setting

### ● Moving from the Communications Setting Level to the Operation Level

<p><b>1</b> Press the  Key for less than 1 second in the Communications Setting Level. The display will change from the Communications Setting Level to the Initial Setting Level.</p>	<p>Communications Setting Level</p> 
<p><b>2</b> Press the  Key for at least 1 second in the Initial Setting Level.</p> <p>The display will change from the Initial Setting Level to the Operation Level.</p>	<p>Initial Setting Level</p>  Input Type <p>Operation Level</p>  PV/SP

## 4-2 Initial Setup Examples through Starting Program Operation

---

The initial setup, including setting the sensor input type, alarm types, control periods, program-related parameters, and other parameters, is done using parameter displays. To change the parameter that is displayed, use the  and  Keys. You can also use these keys to change the level depending on how long you press the key.

### 4-2-1 Program Operation

With program operation, the SP changes with time. The broken-line pattern that represents the changes in the SP over time is called a program. The programs are set in advance by the user.

You can create up to eight programs (i.e., patterns). You can set up to 32 segments (i.e., straight lines) in each program. For details, refer to *4-7 Setting Programs*.

There are the following two ways that you can use to set programs.

- Step time programming: You set the target SP and target time for each segment.
- Rate of rise programming: You set the segment format (ramp, soak, or step) and other parameters for each segment.

Setup examples are given below for both step time programming and rate of rise programming through the start of program operation.

## 4-2-2 Initial Setup Example for Step Time Programming

This example shows how to create the following program with step time programming.

### Programming Example for Step Time Programming

In this example of step time programming, the program starts with a ramp. The segment time is 0, so you set only the segment SP.

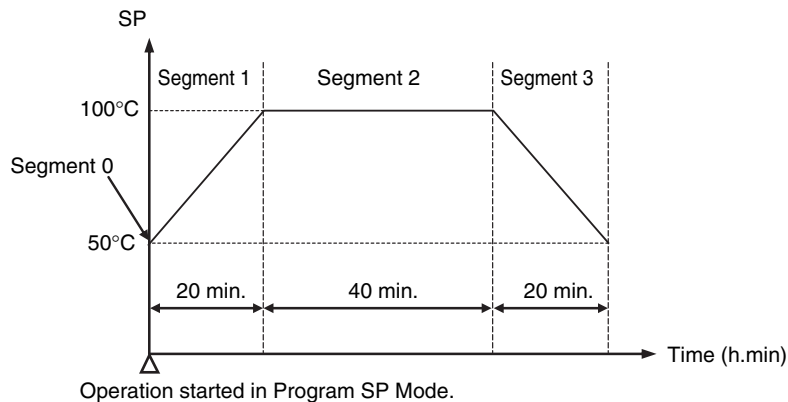

#### ● Related Parameters

Parameter	Parameter	Setting level
Input Type	5: K thermocouple (default)	Initial Setting Level
PID ON/OFF	2-PID control (default)	Initial Setting Level
Alarm type	2: Upper-limit (default)	Initial Setting Level
Program Time Unit	Hours and minutes (default)	Initial Setting Level
Step Time/Rate of Rise Programming	Step time programming (default)	Initial Setting Level
Reset Operation	Stop control	Initial Setting Level
Startup Operation	Continue (default)	Initial Setting Level
Operation End Operation	Reset status (default)	Initial Setting Level
SP Mode	PSP: Program SP (default)	Adjustment Level
Program Number	0 (default)	Program Setting Level
Number of Segments Used	4	Program Setting Level
PID Set No.	1 (default)	Program Setting Level
Alarm Value	30°C	Program Setting Level
Segment Number	0      1      2      3	Program Setting Level
Segment SP	50      100      100      50	Program Setting Level
Segment Time	0.00      0.20      0.40      0.20	Program Setting Level

## Operating Flow for Step Time Programming

Item	Operating flow	Settings	Page
<p><b>1</b> Make the initial settings other than program-related settings.</p> <p><b>2</b> Make the initial program-related settings.</p>	<pre> graph TD     A[Power ON] --&gt; B[Initial Setting Level]     subgraph B [Initial Setting Level]         B1[Set the Input Type parameter.] --&gt; B2[Set the PID ON/OFF parameter.]         B2 --&gt; B3[Set the Alarm Type parameter.]     end     B --&gt; C[Initial Setting Level]     subgraph C [Initial Setting Level]         C1[Set the Program Time Unit parameter.] --&gt; C2[Set the Step Time/Rate of Rise Programming parameter.]         C2 --&gt; C3[Set the Reset Operation parameter.]         C3 --&gt; C4[Set the Startup Operation parameter.]         C4 --&gt; C5[Set the Operation End Operation parameter.]     end     C --&gt; D[Adjustment Level]     subgraph D [Adjustment Level]         D1[Set the SP Mode parameter.]     end     D --&gt; E[ ]     </pre>	<p>Turn ON the power supply and then press the  Key for at least three seconds to move to the Initial Setting Level.</p> <p>Set the parameter to a K thermocouple (default).</p> <p>Set the parameter to PID control (default).</p> <p>Set the parameter to an upper-limit alarm (default).</p> <p>Set the parameter to hours and minutes (default).</p> <p>Set the parameter to step time programming (default).</p> <p>Set the parameter to stop control (default).</p> <p>Set the parameter to continue operation (default).</p> <p>Set the parameter to reset status (default).</p> <p>Set the parameter to the program SP (default).</p>	<p>4-3</p> <p>4-18</p> <p>4-21</p> <p>4-56</p> <p>4-33</p> <p>4-34</p> <p>4-35</p> <p>4-36</p> <p>4-38</p> <p>4-38</p>

Item	Operating flow	Settings	Page
<p><b>3</b> Create the program.</p>		<ul style="list-style-type: none"> <li>• Set the program number to 0 (default).</li> <li>• Set the parameter to 4.</li> <li>• Set the parameter to the number of the segment to edit.</li> <li>• Set the following SPs. Segment 0: 50°C Segment 1: 100°C Segment 2: 100°C Segment 3: 50°C</li> <li>• Set the following times. Segment 0: 0 minutes Segment 1: 20 minutes Segment 2: 40 minutes Segment 3: 20 minutes</li> <li>• Set the parameter to PID set 1. (default).</li> <li>• Set the alarm value to 30°C.</li> </ul>	<p>4-39</p> <p>4-40</p> <p>4-40</p> <p>4-41</p> <p>4-42</p> <p>4-43</p> <p>4-43</p>
<p><b>4</b> Trial Operation</p>		<ul style="list-style-type: none"> <li>• Set the Run/Reset parameter to Run.</li> <li>• Use the Process Value/Set Point 1/2 parameter in the Operation Level to confirm that the SP has reached 100°C.</li> </ul>	<p>6-14</p>
<p><b>5</b> Determine the PID constants.</p>		<ul style="list-style-type: none"> <li>• Execute 100% AT. * The results are applied to PID set 1.</li> <li>• Execute autotuning for the SP that is the most important in control. For this program, autotuning is executed for 100°C.</li> </ul>	<p>4-49</p>
<p><b>6</b> Start program operation.</p>		<ul style="list-style-type: none"> <li>• Set the Run/Reset parameter to Run.</li> </ul>	<p>6-14</p>

Refer to 4-7 Setting Programs for details on the step time programming example.



**Additional Information**

If you need to execute autotuning before the SP is reached, change the SP Mode parameter to Fixed SP Mode, set the desired SP, and then execute autotuning.

### 4-2-3 Initial Setup Example for Rate of Rise Programming

This example shows how to create the following program with rate of rise programming.

#### Programming Example for Rate of Rise Programming

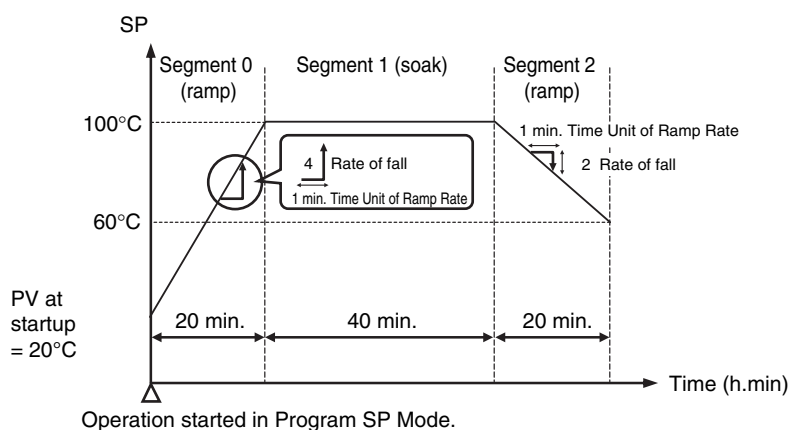

In this example of rate of rise programming, the program starts with a ramp. Program operation is started from the PV. To start operation from a specific SP, set the Segment Format parameter for segment 0 to a step.



#### ● Related Parameters

Parameter	Settings			Setting level
Input Type	5: K thermocouple (default)			Initial Setting Level
PID ON/OFF	2-PID control (default)			Initial Setting Level
Alarm type	2: Upper-limit (default)			Initial Setting Level
Program Time Unit	Hours and minutes (default)			Initial Setting Level
Step Time/Rate of Rise Programming	Rate of rise programming			Initial Setting Level
Time Unit of Ramp Rate	Minutes (default)			Initial Setting Level
Reset Operation	Stop control (default)			Initial Setting Level
Startup Operation	Continue (default)			Initial Setting Level
Operation End Operation	Reset status (default)			Initial Setting Level
SP Mode	PSP: Program SP (default)			Adjustment Level
Alarm Value	30°C			Program Setting Level
Program Number	0 (default)			Program Setting Level
Number of Segments Used	4			Program Setting Level
PID Set No.	1 (default)			Program Setting Level
Segment Number	0	1	2	Program Setting Level
Segment Format	Ramp (default)	Soak	Ramp (default)	Program Setting Level
Segment SP	100	---	60	Program Setting Level
Segment Slope	4	---	2	Program Setting Level
Segment Time	---	0.40	---	Program Setting Level

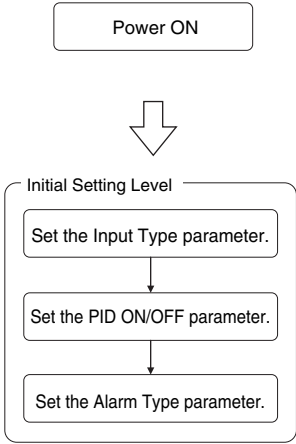
## Operating Flow for Rate of Rise Programming

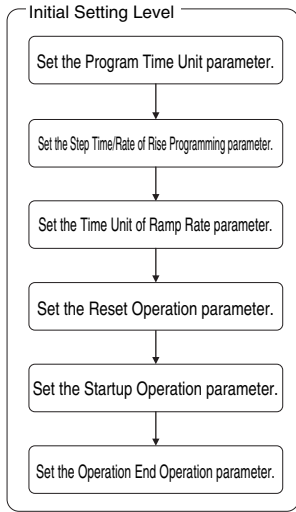
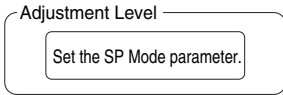
Item	Operating flow	Settings	Page
<p><b>1</b> Make the initial settings other than program-related settings.</p>	 <pre> graph TD     A[Power ON] --&gt; B[Initial Setting Level]     subgraph B [Initial Setting Level]         B1[Set the Input Type parameter.] --&gt; B2[Set the PID ON/OFF parameter.]         B2 --&gt; B3[Set the Alarm Type parameter.]     end     B --&gt; C[Initial Setting Level]             </pre>	<p>Turn ON the power supply and then press the  Key for at least three seconds to move to the Initial Setting Level.</p> <p>Set the parameter to a K thermocouple (default).</p> <p>Set the parameter to PID control (default).</p> <p>Set the parameter to an upper-limit alarm (default).</p>	<p>4-3</p> <p>4-18</p> <p>4-21</p> <p>4-56</p>
<p><b>2</b> Make the initial program-related settings.</p>	 <pre> graph TD     A[Initial Setting Level] --&gt; B[Set the Program Time Unit parameter.]     B --&gt; C[Set the Step Time/Rate of Rise Programming parameter.]     C --&gt; D[Set the Time Unit of Ramp Rate parameter.]     D --&gt; E[Set the Reset Operation parameter.]     E --&gt; F[Set the Startup Operation parameter.]     F --&gt; G[Set the Operation End Operation parameter.]     G --&gt; H[Adjustment Level]             </pre>	<p>Set the parameter to hours and minutes (default).</p> <p>Set the parameter to rate of rise programming. (default).</p> <p>Set the parameter to minutes (default).</p> <p>Set the parameter to stop control (default).</p> <p>Set the parameter to continue operation (default).</p> <p>Set the parameter to reset status (default).</p>	<p>4-33</p> <p>4-34</p> <p>4-35</p> <p>4-35</p> <p>4-36</p> <p>4-38</p>
	 <pre> graph TD     A[Adjustment Level] --&gt; B[Set the SP Mode parameter.]             </pre>	<p>Set the parameter to the program SP (default).</p>	<p>4-38</p>

Item	Operating flow	Settings	Page
<p><b>3</b> Create the program.</p>	<pre> graph TD     subgraph Program_Setting_Level [Program Setting Level]         A[Set the Program Number parameter.] --&gt; B[Set the Number of Segments Used parameter.]         B --&gt; C[Set the Segment Number parameter.]         C --&gt; D[Set the segments.]         D --&gt; E[Set the segment formats (for segments 0 to 2).]         E --&gt; F[Set the segment SPs (for segments 0 to 2).]         F --&gt; G[Set the segment slopes (for segments 0 to 2).]         G --&gt; H[Set the segment times (for segments 0 to 2).]         H --&gt; I[Set the program.]         I --&gt; J[Set the PID Set No. parameter.]         J --&gt; K[Set the Alarm Value parameter.]     end         </pre>	<ul style="list-style-type: none"> <li>• Set the program number to 0 (default).</li> <li>• Set the parameter to 3.</li> <li>• Set the parameter to the number of the segment to edit.</li> <li>• Set the following formats. Segment 0: Ramp Segment 1: Soak Segment 2: Ramp</li> <li>• Set the following SPs. Segment 0: 100°C Segment 1: None Segment 2: 60°C</li> <li>• Set the following slopes. Segment 0: 4 Segment 1: None Segment 2: 2</li> <li>• Set the following times. Segment 0: None Segment 1: 40 minutes Segment 2: None</li> <li>• Set the parameter to PID set 1. (default).</li> <li>• Set the alarm value to 30°C.</li> </ul>	<p>4-39</p> <p>4-40</p> <p>4-40</p> <p>4-41</p> <p>4-41</p> <p>4-42</p> <p>4-42</p> <p>4-43</p> <p>4-43</p>
<p><b>4</b> Trial Operation</p>	<pre> graph TD     subgraph Operation_Level [Operation Level]         L[Start trial operation.]     end         </pre>	<ul style="list-style-type: none"> <li>• Set the Run/Reset parameter to Run.</li> <li>• Use the Process Value/Set Point 1/2 parameter in the Operation Level to confirm that the PV has reached 100°C.</li> </ul>	<p>6-14</p>
<p><b>5</b> Determine the PID constants.</p>	<pre> graph TD     subgraph Adjustment_Level [Adjustment Level]         M[Execute autotuning.]     end         </pre>	<ul style="list-style-type: none"> <li>• Execute 100% AT. * The results are applied to PID set 1.</li> <li>• Execute autotuning for the SP that is the most important in control. For this program, autotuning is executed for 100°C.</li> </ul>	<p>4-49</p>

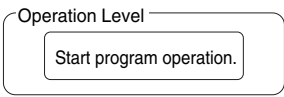

Item	Operating flow	Settings	Page
<b>6</b> Start program operation.		<ul style="list-style-type: none"> <li>• Set the Run/Reset parameter to Run.</li> </ul>	6-14

For details, refer to 4-7 *Setting Programs* for details on the rate of rise programming example.



**Additional Information**

If you need to execute autotuning before the SP is reached, change the SP Mode parameter to Fixed SP Mode, set the desired SP, and then execute autotuning.



## 4-3 Setting the Input Type

The Controller supports four input types: resistance thermometer, thermocouple, infrared temperature sensor, and analog inputs. Set the input type that matches the sensor that is used.

### 4-3-1 Input Type



The following example shows how to set a K thermocouple for  $-20.0$  to  $500.0^{\circ}\text{C}$  (input type 6).

#### Operating Procedure

<p><b>1</b> Press the  Key for at least 3 seconds to move from the Operation Level to the Initial Setting Level. The <math>\bar{I}N-T</math> (Input Type) parameter will be displayed.</p>	<p>Initial Setting Level</p> <div style="border: 1px solid black; padding: 5px; display: inline-block;"> <math>\bar{I}N-T</math> 5         </div> <p>Input Type</p>
<p><b>2</b> Press the  or  Key to select 6 (K thermocouple at <math>-20.0</math> to <math>500.0^{\circ}\text{C}</math>). The default is 5 (5: K thermocouple at <math>-200</math> to <math>1,300^{\circ}\text{C}</math>).</p>	<div style="border: 1px solid black; padding: 5px; display: inline-block;"> <math>\bar{I}N-T</math> 6         </div>



#### Additional Information

Changes that are made with key operations are applied when the  or  Key is pressed. They are also applied if you do nothing for 3 seconds or longer.

## List of Input Types

	Specifications	Set value	Temperature range in °C	Temperature range in °F
Resistance thermometer	Pt100	0	-200 to 850	-300 to 1500
		1	-199.9 to 500.0	-199.9 to 900.0
		2	0.0 to 100.0	0.0 to 210.0
	JPt100	3	-199.9 to 500.0	-199.9 to 900.0
		4	0.0 to 100.0	0.0 to 210.0
Thermocouple	K	5	-200 to 1300	-300 to 2300
		6	-20.0 to 500.0	0.0 to 900.0
	J	7	-100 to 850	-100 to 1500
		8	-20.0 to 400.0	0.0 to 750.0
	T	9	-200 to 400	-300 to 700
		10	-199.9 to 400.0	-199.9 to 700.0
	E	11	-200 to 600	-300 to 1100
	L	12	-100 to 850	-100 to 1500
	U	13	-200 to 400	-300 to 700
		14	-199.9 to 400.0	-199.9 to 700.0
	N	15	-200 to 1300	-300 to 2300
	R	16	0 to 1700	0 to 3000
	S	17	0 to 1700	0 to 3000
	B	18	100 to 1800	300 to 3200
	W	19	0 to 2300	0 to 3200
PLII	20	0 to 1300	0 to 2300	
Infrared temperature sensor ES1B	10 to 70°C	21	0 to 90	0 to 190
	60 to 120°C	22	0 to 120	0 to 240
	115 to 165°C	23	0 to 165	0 to 320
	140 to 260°C	24	0 to 260	0 to 500
Current output	4 to 20 mA	25	One of the following ranges according to the scaling: -1999 to 9999 -199.9 to 999.9 -19.99 to 99.99 -1.999 to 9.999	
	0 to 20 mA	26		
Voltage input	1 to 5 V	27		
	0 to 5 V	28		
	0 to 10 V	29		

The default is 5.



#### Precautions for Correct Use

**S.ERR** (S.ERR: input error) flashes on the display if a sensor is not connected or if the connected sensor is different from input type. Connect a sensor if one is not already connected.

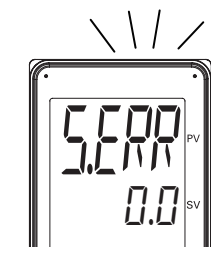



## 4-4 Selecting the Temperature Unit

### 4-4-1 Temperature Unit

- Either °C or °F can be selected as the temperature unit.
- Set the temperature unit in the Temperature Unit (*d-U*) parameter of the Initial Setting Level. The default is  $\bar{\square}$  (°C).  
The following procedure selects °C.

#### Operating Procedure

<p><b>1</b> Press the  Key several times in the Initial Setting Level to display <i>d-U</i> (Temperature Unit).</p>	<p>Initial Setting Level</p> <div style="border: 1px solid black; padding: 5px; display: inline-block;"> <math>d-U</math>  <math>\bar{\square}</math> </div> <p>Temperature Unit</p>
<p><b>2</b> Press the  or  Key to select °C. The default is <math>\bar{\square}</math> (°C). <math>\bar{\square}</math>: °C, <i>F</i>: °F</p>	<div style="border: 1px solid black; padding: 5px; display: inline-block;"> <math>d-U</math>  <math>\bar{\square}</math> </div>

## 4-5 Selecting PID Control or ON/OFF Control (Not Supported for Position-proportional Models.)

Two control methods are supported: 2-PID control and ON/OFF control. Switching between 2-PID control and ON/OFF control is executed by means of the PID ON/OFF parameter in the initial setting level. When this parameter is set to  $P\bar{L}d$ , 2-PID control is selected, and when set to  $\bar{a}N\bar{o}F$ , ON/OFF control is selected. The default is  $P\bar{L}d$ .

### ● 2-PID Control

PID control is set by AT (auto-tuning) or manual setting.

For PID control, set the PID constants in the Proportional Band ( $P$ ), Integral Time ( $\bar{L}$ ), and Derivative Time ( $d$ ) parameters.

For heating and cooling control, also set the Proportional Band (Cooling) ( $\bar{L}-P$ ), Integral Time (Cooling) ( $\bar{L}-\bar{L}$ ), and Derivative Time (Cooling) ( $\bar{L}-d$ ).

### ● ON/OFF Control

In ON/OFF control, the control output is turned ON when the process value is lower than the current set point, and the control output is turned OFF when the process value is higher than the current set point (reverse operation).

## Setting the Control Method

Set the control method to 2-PID control. The default is 2-PID control.

### ● Related Parameters

Parameter name	Display	Setting range	Default	Level
PID ON/OFF	$\bar{C}N\bar{E}L$	$P\bar{L}d$ : 2-PID control $\bar{a}N\bar{o}F$ : ON/OFF	$P\bar{L}d$	Initial Setting Level

### Operating Procedure

<p><b>1</b> Press the <math>\bar{C}</math> Key several times in the Initial Setting Level to display the PID ON/OFF parameter.</p>	<p>Initial Setting Level</p> <div style="border: 1px solid black; padding: 5px; display: inline-block;"> <math>\bar{C}N\bar{E}L</math>  <math>P\bar{L}d</math> </div> PID ON/OFF
<p><b>2</b> Press the <math>\bar{A}</math> or <math>\bar{D}</math> Key to select <math>P\bar{L}d</math> (2-PID control). The default is <math>P\bar{L}d</math> (2-PID control).</p>	<div style="border: 1px solid black; padding: 5px; display: inline-block;"> <math>\bar{C}N\bar{E}L</math>  <math>P\bar{L}d</math> </div>

## 4-6 Setting Output Specifications

### 4-6-1 Control Periods (Not Supported for Position-proportional Models.)

$CP$  Control Period (Heating)

$C-CP$  Control Period (Cooling)

- Set the output periods (control periods). Though a shorter period provides better control performance, it is recommended that the control period be set to 20 seconds or longer for a relay output to preserve the service life of the relay. After the settings have been made in the initial setup, readjust the control period, as required, by means such as trial operation.
- Set the control periods in the Control Period (Heating) and Control Period (Cooling) parameters in the Initial Setting Level. The default is 20 seconds for a relay output and 2 seconds for a voltage output (for driving SSR).
- The control periods are used only for PID control.
- The Control Period (Cooling) parameter is used only for heating/cooling control.
- When control output is used as a current output, the Control Period parameter cannot be used.

### 4-6-2 Direct and Reverse Operation

$\bar{a}REV$

- Direct operation increases the manipulated variable whenever the process value increases. Reverse operation decreases the manipulated variable whenever the process value increases.

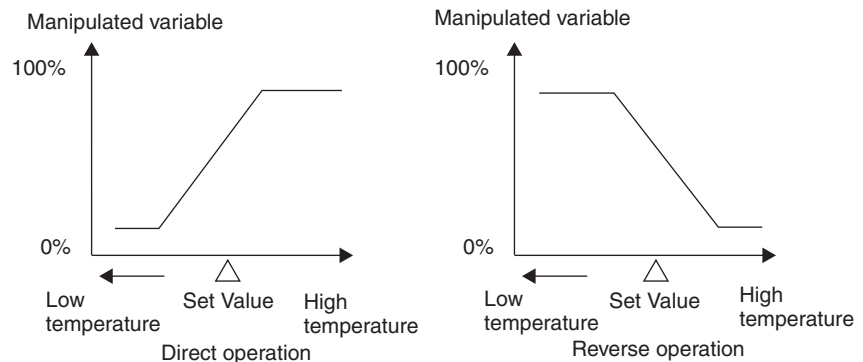

For example, when the process value (PV) is lower than the set point (SP) in a heating control system, the manipulated variable increases according to the difference between the PV and SP. Accordingly, reverse operation is used in a heating control system. Direct operation is used in a cooling control system, in which the operation is the opposite of a heating control system. The Control Output 1 Assignment is set to  $\bar{a}$  (control output (heating)) for either direct or reverse operation.

- Direct/reverse operation is set in the Direct/Reverse Operation parameter in the Initial Setting Level. The default is  $\bar{a}R-R$  (reverse operation).

In this example, direct/reverse operation, and control period (heating) parameters are checked.

Direct/reverse operation =  $\bar{a}R-R$  (reverse operation)

Control period (heating) = 20 (seconds)

**Operating Procedure**

- Setting the Control Period (Heating) Parameter

<p><b>1</b> Press the <math>\text{☰}</math> Key several times in the Initial Setting Level to display <math>CP</math> (Control Period (Heating)).</p>	<p>Initial Setting Level</p> <div style="border: 1px solid black; padding: 5px; display: inline-block;"> <math>CP</math> 20                 </div> <p>Control Period (Heating)</p>
<p><b>2</b> Press the <math>\text{▲}</math> or <math>\text{▼}</math> Key to set the value to 20. The default for a relay output is 20 seconds.</p>	<div style="border: 1px solid black; padding: 5px; display: inline-block;"> <math>CP</math> 20                 </div>

- Setting Direct/Reverse Operation

<p><b>1</b> Press the <math>\text{☰}</math> Key several times in the Initial Setting Level to display <math>\bar{a}REV</math> (Direct/Reverse Operation).</p>	<p>Initial Setting Level</p> <div style="border: 1px solid black; padding: 5px; display: inline-block;"> <math>\bar{a}REV</math> <math>\bar{a}R-R</math> </div> <p>Direct/Reverse Operation</p>
<p><b>2</b> Press the <math>\text{▲}</math> or <math>\text{▼}</math> Key to select <math>\bar{a}R-R</math> (Reverse Operation). The default is <math>\bar{a}R-R</math> (Reverse Operation).</p>	<div style="border: 1px solid black; padding: 5px; display: inline-block;"> <math>\bar{a}REV</math> <math>\bar{a}R-R</math> </div>

**4-6-3 Assigned Output Functions (Assigning Control Outputs Is Not Supported for Position-proportional Models.)**

- Function assignments can be changed by changing the settings for control and auxiliary output assignments.
- The default function assignments for each output are shown below.

Parameter name	Display	Initial status
Control Output 1 Assignment	$\bar{a}Ut 1$	Control output (heating)
Control Output 2 Assignment	$\bar{a}Ut 2$	Not assigned.
Auxiliary Output 1 Assignment	$Sub 1$	Alarm 1*
Auxiliary Output 2 Assignment	$Sub 2$	Alarm 2
Auxiliary Output 3 Assignment	$Sub 3$	Alarm 3
Auxiliary Output 4 Assignment (E5EC-T/E5AC-T only)	$Sub 4$	Alarm 4

\* If the Controller is equipped with HB/HS alarm detection, it is set by default to detect heater alarms (HA). Therefore, the alarm 1 function is disabled and the Alarm 1 Type is not displayed. To enable alarm 1, set an output assignment to alarm 1.

- Refer to page 6-98 for the functions that can be assigned to the outputs.
- Each output is automatically initialized as shown below by changing the control mode between standard and heating/cooling.

## Assigned Output Functions

E5CC-T

Parameter name	Display	Without control output 2		With control output 2	
		Standard	Heating/cooling	Standard	Heating/cooling
Control Output 1 Assignment	<i>ōbt 1</i>	Control output (heating)	Control output (heating)	Control output (heating)	Control output (heating)
Control Output 2 Assignment	<i>ōbt 2</i>	---	---	Not assigned.	Control output (cooling)
Auxiliary Output 1 Assignment	<i>Sub 1</i>	Alarm 1*	Alarm 1*	Alarm 1*	Alarm 1*
Auxiliary Output 2 Assignment	<i>Sub 2</i>	Alarm 2	Control output (cooling)	Alarm 2	Alarm 2
Auxiliary Output 3 Assignment	<i>Sub 3</i>	Alarm 3	Alarm 3	Alarm 3	Alarm 3

E5EC-T or E5AC-T

Parameter name	Display	Without control output 2		With control output 2	
		Standard	Heating/cooling	Standard	Heating/cooling
Control Output 1 Assignment	<i>ōbt 1</i>	Control output (heating)	Control output (heating)	Control output (heating)	Control output (heating)
Control Output 2 Assignment	<i>ōbt 2</i>	---	---	Not assigned.	Control output (cooling)
Auxiliary Output 1 Assignment	<i>Sub 1</i>	Alarm 1*	Alarm 1*	Alarm 1*	Alarm 1*
Auxiliary Output 2 Assignment	<i>Sub 2</i>	Alarm 2	Alarm 2	Alarm 2	Alarm 2
Auxiliary Output 3 Assignment	<i>Sub 3</i>	Alarm 3	Alarm 3	Alarm 3	Alarm 3
Auxiliary Output 4 Assignment	<i>Sub 4</i>	Alarm 4	Control output (cooling)	Alarm 4	Alarm 4

- \* If the Controller is equipped with HB/HS alarm detection, it is set by default to detect heater alarms (HA). Therefore, the alarm 1 function is disabled and the Alarm 1 Type is not displayed. To enable alarm 1, set an output assignment to alarm 1.

### ● Alarms

It will be specified in this section when an alarm must be assigned, i.e., when an alarm must be set for the Control Output 1 or 2 Assignment parameters, or for the Auxiliary Output 1 to 4 Assignment parameters. For example, if alarm 1 is set for the Control Output 1 Assignment parameter, then alarm 1 has been assigned.

Assigning a work bit to either control output 1 or 2 or to auxiliary output 1 to 4 is also considered to be the same as assigning an alarm. For example, if work bit 1 is set for the Auxiliary Output 1 Assignment parameter, then alarms 1 to 4 have been assigned.



Assign the control outputs and auxiliary outputs.

Control output 1: Control output (heating)









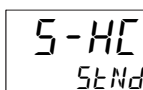

Control output 2: Control output (cooling)

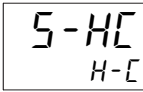
Auxiliary output 1: Alarm 1

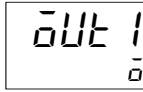
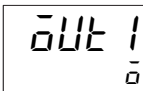

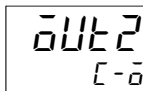
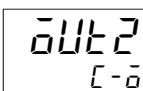
Auxiliary output 2: Alarm 2

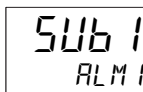
#### Operating Procedure

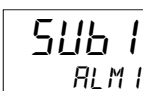
- Setting Heating/Cooling Control

<p><b>1</b> Press the  Key several times in the Initial Setting Level to display <b>5-HC</b> (Standard or Heating/Cooling).</p>	<p>Initial Setting Level</p>  <p>Standard or Heating/Cooling</p>
<p><b>2</b> Press the  or  Key to set the parameter to <b>H-C</b>. The default is <b>5END</b> (standard).</p>	
<p>* Use the following procedures to check the output assignments. The output assignments are changed automatically when you change between standard and heating/cooling control. You do not have to set them.</p>	
<ul style="list-style-type: none"> <li>• Setting Control Output 1</li> </ul>	
<p><b>1</b> Press the  Key several times in the Advanced Function Setting Level to display <b>out 1</b> (Control Output 1 Assignment).</p>	<p>Advanced Function Setting Level</p>  <p>Control Output 1 Assignment</p>
<p><b>2</b> Set the parameter to <b>ā</b> (Control Output (Heating)). The default is <b>ā</b> (Control Output (Heating)).</p>	
<ul style="list-style-type: none"> <li>• Setting Control Output 2</li> </ul>	
<p><b>1</b> Press the  Key several times in the Advanced Function Setting Level to display <b>out 2</b> (Control Output 2 Assignment).</p>	<p>Advanced Function Setting Level</p>  <p>Control Output 2 Assignment</p>
<p><b>2</b> Set the parameter to <b>C-ā</b> (Control Output (Cooling)). As soon as you select <b>H-C</b> (Heating/Cooling) for the Standard or Heating/Cooling parameter, the setting of this parameter is automatically changed to <b>C-ā</b> (Control Output (Cooling)).</p>	
<ul style="list-style-type: none"> <li>• Setting Auxiliary Output 1</li> </ul>	
<p><b>1</b> Press the  Key several times in the Advanced Function Setting Level to display <b>Sub 1</b> (Auxiliary Output 1 Assignment).</p>	<p>Advanced Function Setting Level</p>  <p>Auxiliary Output 1 Assignment</p>
<p><b>2</b> Press the  or  Key to set the parameter to <b>ALM 1</b>. The default is <b>ALM 1</b> (Alarm 1). If the Controller is equipped with HB/HS alarm detection, this parameter is set by default to <b>HR</b> (heater alarm).</p>	

- Setting Auxiliary Output 2

<p><b>1</b> Press the  Key several times in the Advanced Function Setting Level to display <i>SUB2</i> (Auxiliary Output 2 Assignment).</p>	<p>Advanced Function Setting Level</p> <div style="display: flex; align-items: center;"> <div style="border: 1px solid black; padding: 5px; margin-right: 10px;"> <p style="font-size: 1.2em; margin: 0;"><i>SUB2</i></p> <p style="font-size: 0.8em; margin: 0;"><i>ALM2</i></p> </div> <p style="margin: 0;">Auxiliary Output 2 Assignment</p> </div>
<p><b>2</b> Press the  or  Key to set the parameter to <i>ALM2</i>. The default is <i>ALM2</i> (Alarm 2).</p>	<div style="border: 1px solid black; padding: 5px;"> <p style="font-size: 1.2em; margin: 0;"><i>SUB2</i></p> <p style="font-size: 0.8em; margin: 0;"><i>ALM2</i></p> </div>

#### 4-6-4 Auxiliary Output Opening or Closing in Alarm

- When "close in alarm" is set, the status of the auxiliary output is output unchanged. When "open in alarm" is set, the status of the auxiliary output function is reversed before being output.
- Each auxiliary output can be set independently.
- These settings are made in the Auxiliary Output 1 to 4 Open in Alarm parameters (Advanced Function Setting Level).
- The default is  $N-\bar{a}$ : Close in Alarm.

	Auxiliary output functions 1 to 4	Auxiliary output	Indicators (SUB1 to SUB4)
Close in Alarm ( $N-\bar{a}$ )	ON	ON	Lit
	OFF	OFF	Not lit
Open in Alarm ( $N-L$ )	ON	OFF	Lit
	OFF	ON	Not lit

- The alarm output will turn OFF (i.e., the relay contacts will open) when power is interrupted and for about two seconds after the power is turned ON regardless of the setting of the Auxiliary Output 1 to 4 Open in Alarm parameter.

# 4-7 Setting Programs

## 4-7-1 Programming

### Introduction

You program operation so that the SP changes with time. The broken-line pattern that represents the changes in the SP over time is called a program. The programs are set in advance by the user. The main features are as follows:

- You can create up to eight programs (i.e., patterns).
- You can set up to 32 segments (i.e., straight lines) for each program.
- There are three segment formats: ramp (sloped), soak (horizontal), and step (vertical).
- Program operation starts when you change the Run/Reset parameter to Run. Details on the Run/Reset parameter are described in the next section.

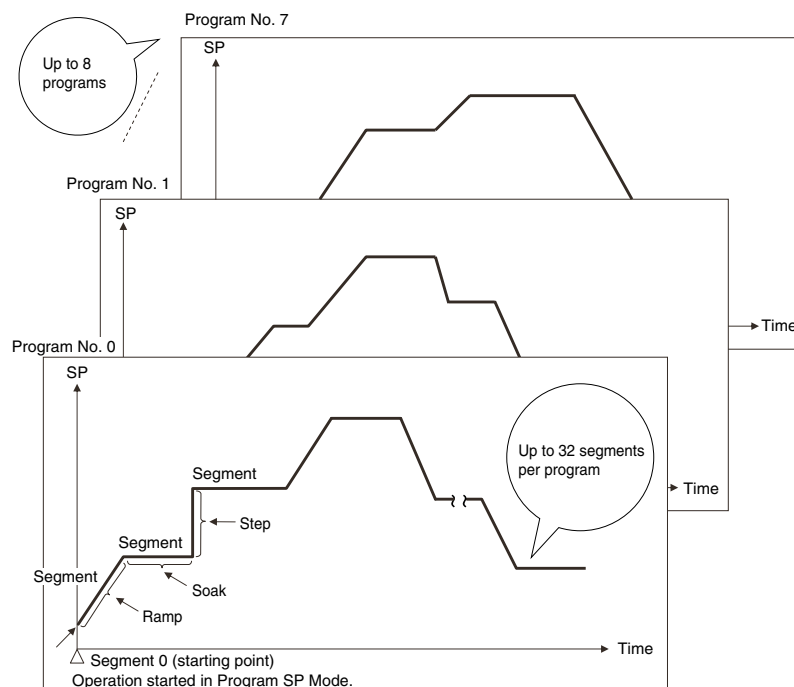

### Run/Reset Parameter

“Run” indicates that program operation is in progress. “Reset” indicates that the program is stopped. You can use the Reset Operation parameter to specify whether fixed SP operation is to be performed or control is to be stopped all together while the program is stopped. For details, refer to *Selecting the Reset Operation*, below.

The run/reset status changes at the following times. The default is *RESET* (reset).

- When the **MODE** (Mode) and **ENTER** (Enter) Keys are pressed simultaneously for at least 1 s
- When the *R-R* parameter (Run/Reset) in the Operation Level is changed to *RUN*
- When the run/reset status is changed with the **PF** (PF) Key
- When the run/reset status is changed with an event input



#### Additional Information

You can set the Standby Time parameter to delay the start of program operation after changing from reset to run status. For details, refer to *5-15-13 Standby Operation*.

## Programming Methods

There are two programming methods: Step Time Programming, in which the time and SP are set, and Rate of Rise Programming, in which the segment type is set (to ramp, soak, or step) and the time, SP, and/or slope are set.

### ● Step Time Programming

- With step time programming, you set the SP and time for each segment.
- The SP of the previous segment is the starting point, you set the ending point as the SP of the current segment, and you set the time from the starting point to the ending point.

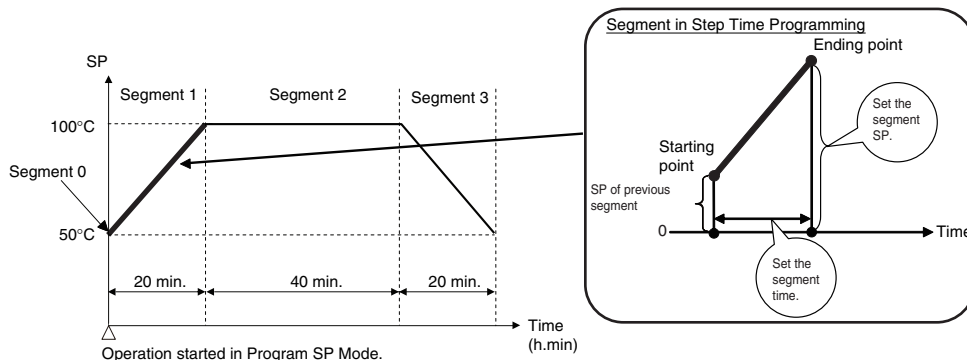

- You cannot select the segment format for step time programming. The format is determined by the time and SP.

Details are as follows:

- Ramp: If the SP is different from the SP for the previous segment, the segment becomes a ramp segment.
- Soak: If the SP is the same as the SP for the previous segment, the segment becomes a soak segment. However, if the Reset Operation parameter is set to stop control, segment 0 is a soak segment.
- Step: If the segment time is set to 0, the segment becomes a step segment.

## ● Rate of Rise Programming

- You set the segment type (soak, ramp, or step) and other parameters for each segment.
  - Ramp: You set only the SP and slope. You set the ending point as the SP and the slope until reaching the SP.
  - Soak: You set only the time.
  - Step: You set only the SP.

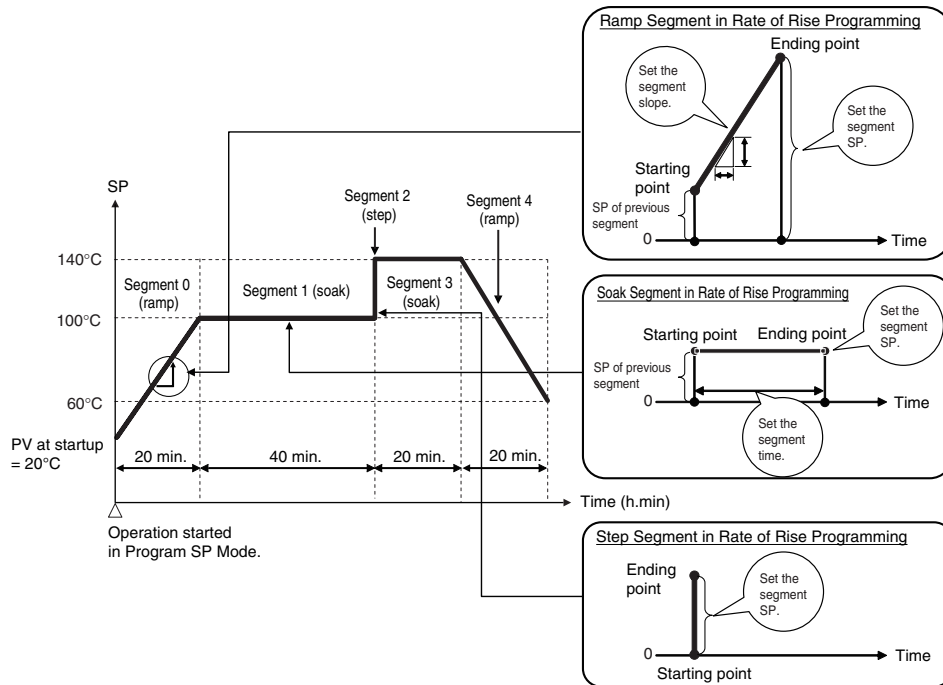

### Additional Information

For segment 0, the segment SP that serves as the starting point is one of the following depending on the settings of the Operation at Reset and Step Time/Rate of Rise Programming parameters.

- Segment 0 SP
- Process value (PV)
- Fixed SP

For details, refer to *Reset Operation*, *Step Time/Rate of Rise Programming*, and *Programming Pattern Starting Points* on page 4-36.

## 4-7-2 Program Patterns

Program patterns are shown below. The starting segment changes as shown below depending on whether the starting point is the PV, fixed SP, or a set SP.

### ● Starting Point = PV or Fixed SP: Segment 0 Is Starting Segment

Starting Point Is PV and Segment Is Ramp

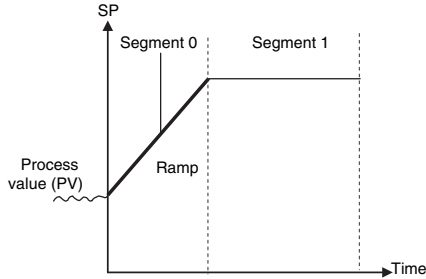

Starting Point Is Fixed SP and Segment Is Ramp

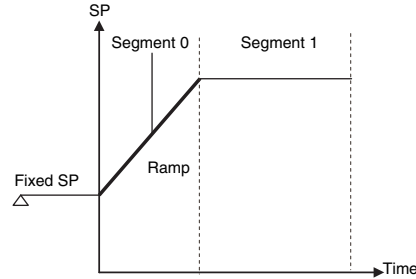

Starting Point Is PV and Segment Is Soak

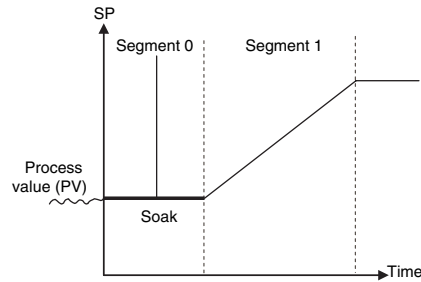

Starting Point Is Fixed SP and Segment Is Soak

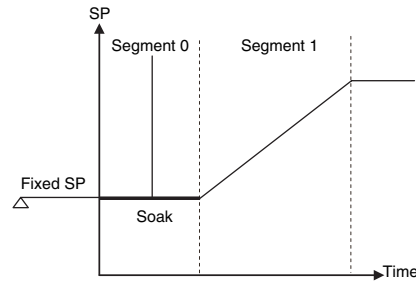

*RLESM* (Reset Operation) is set as follows:

- Reset Operation = Stop control
- Valid only with rate of rise programming

*RLESM* (Reset Operation) is set as follows:

- Reset operation = Fixed SP operation
- Either step time or rate of rise programming

● **Starting Point = Set SP: Segment 1 Is Starting Segment (Segment 0 = Step Operation)**

Starting Point Is PV and Segment Is Ramp

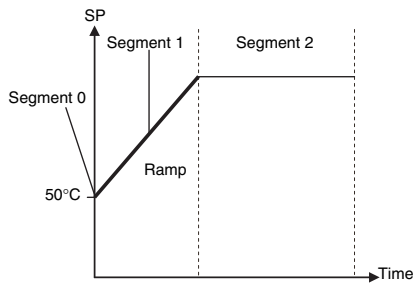

Starting Point Is PV and Segment Is Soak

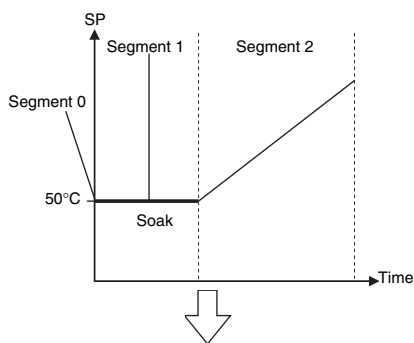

*RESM* (Reset Operation) is set as follows:

- Reset Operation = Stop control
- Either step time or rate of rise programming

For details on program patterns, refer to *A-8 Setting Levels Diagram*.

### 4-7-3 Setting Flow for Program-related Settings

After you set the parameters related to the initial program settings, set the parameter to create the program. The setting flows for program-related parameters are given below.

#### ● Initial Program-related Settings

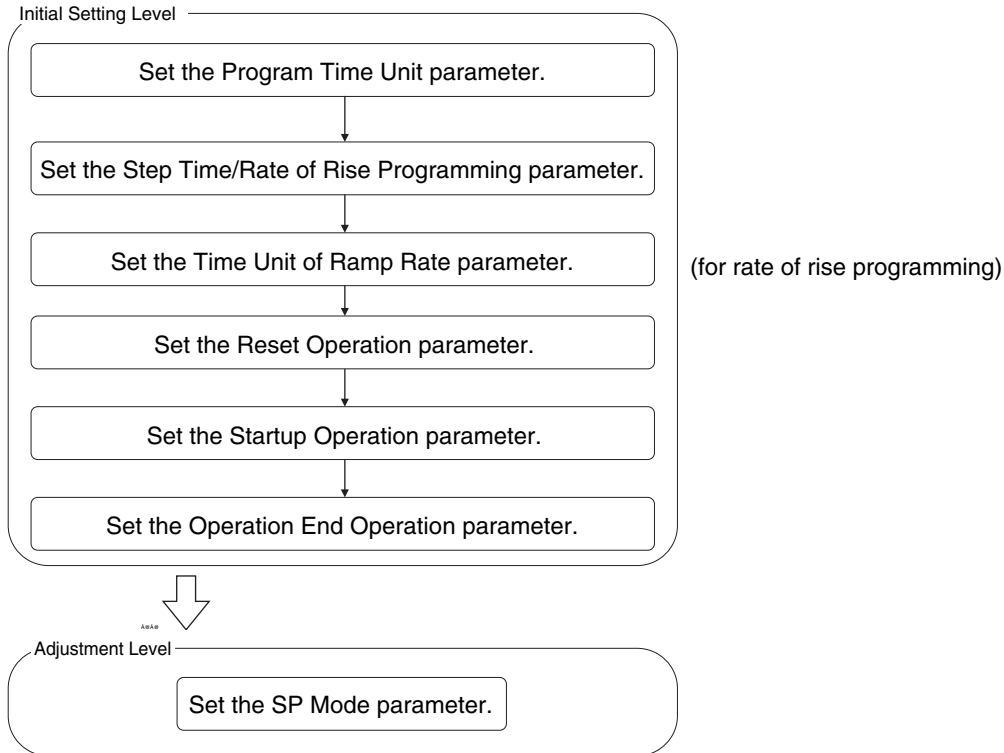

#### ● Creating the Program

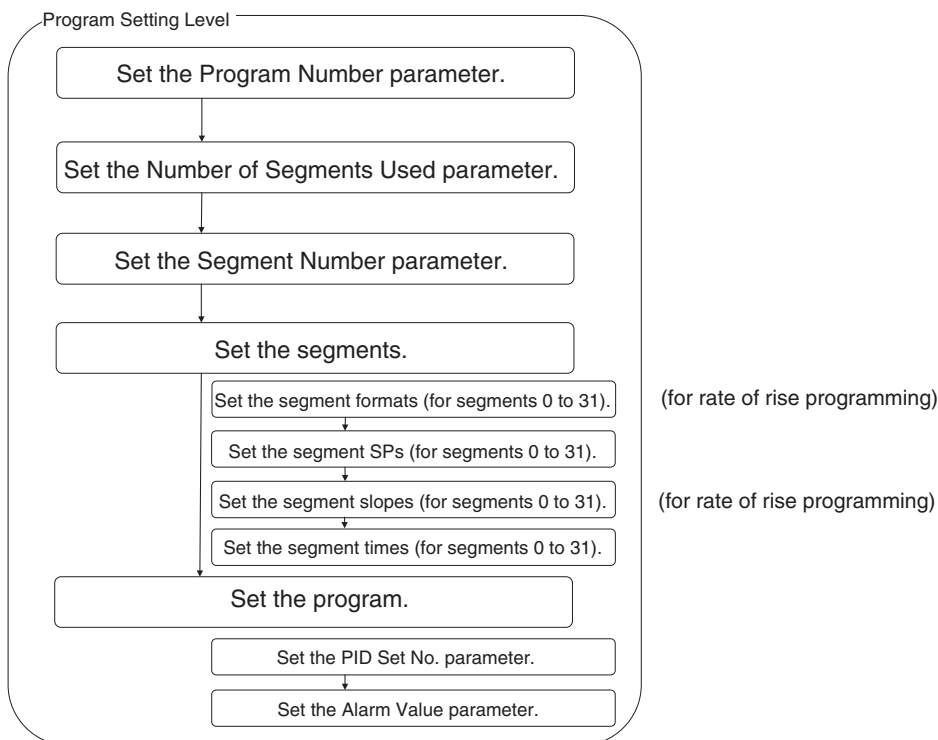



The parameter setting procedures for the example in 4-2 *Initial Setup Examples through Starting Program Operation* are given starting on the next page.

### 4-7-4 Making the Initial Program-related Settings

Set the following parameters before you create the program.

**Set the Program Time Unit parameter.**

- Program Time Unit

**Set the Step Time/Rate of Rise Programming parameter (i.e., the program setting method).**

- Step Time/Rate of Rise Programming

**Set the Time Unit of Ramp Rate parameter (for rate of rise programming).**

- Time Unit of Ramp Rate

**Set the Reset Operation parameter.**

- Reset Operation

**Set the Startup Operation parameter.**

- Startup Operation

**Set the Operation End Operation parameter.**

- Operation End Operation

**Set the SP Mode parameter (when the reset operation is set to stop control).**

- SP Mode

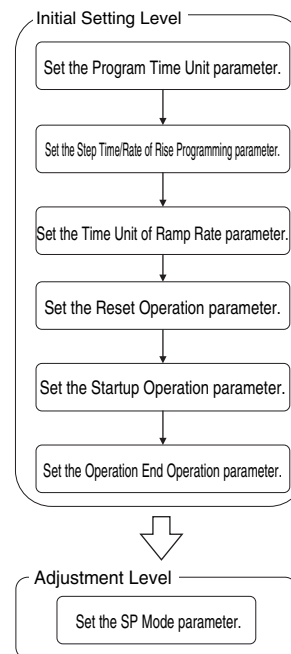

## Setting the Program Time Unit Parameter

This parameter sets the time unit for execution of the program.

● **Related Parameters**

Parameter name	Display	Setting range	Default	Level
Program Time Unit	<i>t-U</i>	<i>H-M</i> : Hours and minutes <i>M-S</i> : Minutes and seconds	<i>H-M</i>	Initial Setting Level

● **Setting Example**

The following example shows how to set hours and minutes.

**Operating Procedure**

<p><b>1</b> Press the  Key several times in the Initial Setting Level to select the Program Time Unit parameter.</p>	<p>Initial Setting Level</p> <div style="border: 1px solid black; padding: 5px; display: inline-block;"> <p><i>t-U</i> Program <i>H-M</i> Time Unit</p> </div>
<p><b>2</b> Press the  or  Key to set hours and minutes The default is hours and minutes.</p>	<div style="border: 1px solid black; padding: 5px; display: inline-block;"> <p><i>t-U</i> <i>H-M</i></p> </div>

## Setting the Step Time/Rate of Rise Programming Parameter (i.e., the Program Setting Method)

This parameter sets the program setting method.

### ● Related Parameters

Parameter name	Display	Setting range	Default	Level
Step Time/Rate of Rise Programming	$\bar{t}-PR$	$\bar{t}\bar{C}ME$ : Step time programming $PR$ : Rate of rise programming	$\bar{t}\bar{C}ME$	Initial Setting Level

- The setting of the Step Time/Rate of Rise Programming parameter determines which segment parameters are enabled.  
The following table shows which segment parameters are enable according to the setting of the Step Time/Rate of Rise Programming parameter.

Parameter	Setting range	Unit	Setting of Step Time/Rate of Rise Programming parameter			
			Step time programming	Rate of rise programming		
Segment Format	Soak, ramp, or step (default: ramp)	---	No setting <sup>*1</sup>	Must be set.		
				Soak	Ramp	Step
Segment SP	SP lower limit to SP upper limit (default: 0)	EU	Must be set. <sup>*1</sup>	No setting	Must be set.	Must be set.
Segment Slope	0 to 9,999 (default: 0) <sup>*2</sup>	EU/Time Unit of Ramp Rate	No setting	No setting	Must be set. <sup>*2</sup>	No setting
Segment Time	0.00 to 99.59 (default: 0.00)	Program Time Unit (hours.minutes or minutes.seconds)	Must be set.	Must be set.	No setting	No setting



\*1 If the Reset Operation parameter is set to stop control, segment 0 is always a soak segment. The starting and ending points are both the SP of segment 0.

\*2 If the Segment Rate of Rise parameter is set to 0, the segment will be a step segment. Set the unit to minutes (default) or hours in the Time Unit of Ramp Rate parameter.

### ● Setting Example

This example is for setting the programming method to step time programming.

#### Operating Procedure

<p><b>1</b> Press the  Key several times in the Initial Setting Level to select the Step Time/Rate of Rise Programming parameter.</p>	<p>Initial Setting Level</p> <div style="border: 1px solid black; padding: 5px; display: inline-block;"> <math>\bar{t}-PR</math>  <math>\bar{t}\bar{C}ME</math> </div> <p>Program Time Unit</p>
<p><b>2</b> Press the  or  Key to set <math>\bar{t}\bar{C}ME</math> (step time programming). The default is <math>\bar{t}\bar{C}ME</math> (step time programming).</p>	<div style="border: 1px solid black; padding: 5px; display: inline-block;"> <math>\bar{t}-PR</math>  <math>\bar{t}\bar{C}ME</math> </div>

## Setting the Time Unit of Ramp Rate Parameter (for Rate of Rise Programming)

This parameter is set only for rate of rise programming. This parameter sets the time unit for the denominator of the Segment Slope parameter.



### ● Related Parameters

Parameter name	Display	Setting range	Default	Level
Time Unit of Ramp Rate	<i>PRU</i>	<i>H</i> : Hours <i>M</i> : Minutes	<i>M</i>	Initial Setting Level

### ● Setting Example

The following example shows how to set *M* (minutes).

#### Operating Procedure

<p><b>1</b> Press the  Key several times in the Initial Setting Level to select the Time Unit of Ramp Rate parameter.</p>	<p>Initial Setting Level</p> <div style="border: 1px solid black; padding: 5px; display: inline-block;"> <i>PRU</i> <i>M</i> </div> <p>Time Unit of Ramp Rate</p>
<p><b>2</b> Press the  or  Key to set <i>M</i> (minutes). The default is <i>M</i> (minutes).</p>	<div style="border: 1px solid black; padding: 5px; display: inline-block;"> <i>PRU</i> <i>M</i> </div>

## Setting the Reset Operation Parameter

This parameter sets whether to perform control in reset status.

Here, “reset” means that the program is stopped.

- Stop Control (Default)

Control is stopped in reset status.

When operation is started again, program control or fixed SP control is started according to the setting of the SP Mode parameter.

- \* When a program is in reset status, the segment number will be 0, the elapsed program time will be 0, hold status will be cleared, the program repetition counter will be 0, and the program number will be the number of the selected program.

- Fixed SP Operation

Fixed SP control is executed in reset status using the fixed SP.

When operation is started, Program SP Mode is automatically entered and control is started with the program SP.



### ● Related Parameters

Parameter name	Display	Setting range	Default	Level
Reset Operation	<i>RESM</i>	<i>STOP</i> : Stop control <i>FSP</i> : Fixed SP operation	<i>STOP</i>	Initial Setting Level

● **Setting Example**

This example is for setting the parameter to stop control.

**Operating Procedure**

<p><b>1</b> Press the  Key several times in the Initial Setting Level to select the Reset Operation parameter.</p>	<p>Initial Setting Level</p> <div style="border: 1px solid black; padding: 5px; display: inline-block;"> <p><i>RLSM</i> <i>StōP</i></p> </div> <p>Reset Operation</p>
<p><b>2</b> Press the  or  Key to set <i>StōP</i> (stop operation). The default is <i>StōP</i> (stop operation).</p>	<div style="border: 1px solid black; padding: 5px; display: inline-block;"> <p><i>RLSM</i> <i>StōP</i></p> </div>



**Additional Information**

Maintaining the Control Output during Reset Status When the Reset Operation Is Set to Stop Control  
Set the MV to output in the *MV-R* (MV at Reset) parameter. For details, refer to 5-16-2 *MV at Reset*.

● **Reset Operation, Step Time/Rate of Rise Programming, and Programming Pattern Starting Points**

Reset Operation	Setting of Step Time/Rate of Rise Programming parameter	
	Step time programming	Rate of rise programming
Stop control	Starts from SP of segment 0 (always a soak segment). <sup>*1</sup>	Starts from the process value (PV) (either a ramp, soak, or step segment). <sup>*2</sup>
Fixed SP operation	Starts from fixed SP of segment 0.	

- \*1 To start from a ramp segment, set the time for segment 0 to 0 and use segment 1 as a ramp segment.
  - \*2 To start operation from a specific SP, set the Segment Type parameter for segment 0 to a step and set the desired SP.
- Note: The following operation occurs if an input error occurs when starting operation with the reset operation set to stop control. If the segment format of segment 0 is a ramp or step, the program starts from the SP of segment 0. If the segment format of segment 0 is soak, program operation does not start (reset status is entered).

**Setting the Startup Operation Parameter**

This parameter sets the operating status when the power is turned ON. You can set any of the following options.

Operation	Description
• Continue (default)	The status when power was interrupted is continued.
• Reset	Reset status is entered.
• Run	The program (including any standby status) is executed from the beginning.
• Manual Mode	Manual Mode is entered. (This setting cannot be selected if manual operation is disabled.)

The following table shows the settings that are retained depending on the setting of the above Startup Operation parameter.

Parameter	Setting of the Startup Operation parameter			
	Continue	Reset	Run	Manual Mode
Program Number	Retained.	---	---	Retained.

Parameter	Setting of the Startup Operation parameter			
	Continue	Reset	Run	Manual Mode
Segment Number	Retained.	---	---	Retained.
Elapsed Program Time	Retained.	---	---	Retained.
Remaining Standby Time	Retained.	---	---* <sup>2</sup>	Retained.
Program Repetitions	Retained.	---	---	Retained.
Hold Status	Retained.	---	---	Retained.
Auto/Manual	Retained.	Retained.	Retained.	---
Manual MV* <sup>1</sup>	Retained.	Retained.	Retained.	Retained.* <sup>3</sup>
Run/Reset	Retained.	---	---	Retained.

\*1 For position-proportional models, the Direct Setting of Position-Proportional MV parameter must be set to OFF.

\*2 The remaining standby time is set in the Standby Time parameter.

\*3 If Auto Mode was in effect when power was interrupted, the Manual MV will be 0 (OFF) if the Manual Output Method parameter is set to HOLD (retain MV) and it will be the value of the Manual MV Initial Value parameter if the Manual Output Method parameter is set to INIT (output initial value). However, if the Manual Output Method is set to HOLD (retain MV) for position-proportional control, the manual MV will be as follows:

- If the potentiometer input is normal: Valve Opening
- If there is a potentiometer input error and control is stopped: MV at Reset
- If there is a potentiometer input error and control is in progress: MV at PV Error



## ● Related Parameters

Parameter name	Display	Setting range	Default	Level
Startup Operation	P-ON	CONT: Continue RST: Reset RUN: Run MANU: Manual Mode	CONT	Initial Setting Level

## ● Setting Example

The following example shows how to set continuing from the previous status.

### Operating Procedure

<p><b>1</b> Press the  Key several times in the Initial Setting Level to select the Startup Operation parameter.</p>	<p>Initial Setting Level</p> <div style="border: 1px solid black; padding: 5px; display: inline-block;"> <p>P-ON CONT</p> </div> <p>Startup Operation</p>
<p><b>2</b> Press the  or  Key to set Continue. The default is Continue.</p>	<div style="border: 1px solid black; padding: 5px; display: inline-block;"> <p>P-ON CONT</p> </div>

## Setting the Operation End Operation Parameter

This parameter sets the operation to perform when the program has been completed. You can set any of the following options.

- Reset Status (Default)
  - Operation will be ended.
- Continue
  - Operation is continued using the SP of the last segment.
  - The final segment number is held and the elapsed program time is held.

Note 1 The Hold and Advance parameters cannot be used. The time signals retain their status at a normal end of operation.

2 If you change the Number of Segments Used parameter after operation is ended, the operation end status will be held for the SP of the final SP after the parameter is changed.

- Fixed SP Mode
  - Operation is continued in Fixed SP Mode after the program is completed (run status).
  - The segment number and elapsed program time return to the start and are held.

Note 1 Time signals are turned OFF before the end of program operation.

2 If the SP Mode parameter is changed to Program SP Mode (PSP), the program will start again. If, however, the Reset Operation parameter is set to fixed SP operation, Fixed SP Mode cannot be set.



### ● Related Parameters

Parameter name	Display	Setting range	Default	Level
Operation End Operation	ESEt	RSt: Reset status CtNE: Continue FSP: Fixed SP Mode	RSt	Initial Setting Level

### ● Setting Example

The following procedure shows how to set the parameter to reset status.

#### Operating Procedure

<p><b>1</b> Press the  Key several times in the Initial Setting Level to select the Operation End Operation parameter.</p>	<p>Initial Setting Level</p> <div style="border: 1px solid black; padding: 5px; display: inline-block;"> <p>ESEt RSt</p> </div> <p>Operation End Operation</p>
<p><b>2</b> Press the  or  Key to set reset status. The default is reset status.</p>	<div style="border: 1px solid black; padding: 5px; display: inline-block;"> <p>ESEt RSt</p> </div>

## Setting the SP Mode Parameter (When Reset Operation Is Set to Stop Control)

You can select either the program SP or a fixed SP as the SP to use for control.

Before you start program operation, set the SP Mode parameter in the Adjustment Level to Program SP (PSP).

- Program SP (PSP) Mode
 

In this mode, the program SP is used for control.
- Fixed SP (FSP) Mode
 

In this mode, control is performed for a fixed SP that is set by the user.





● **Related Parameters**

Parameter name	Display	Setting range	Default	Level
SP Mode	<i>SPMd</i>	<i>PSP</i> : Program SP <i>FSP</i> : Fixed SP	<i>PSP</i>	Adjustment Level

● **Setting Example**

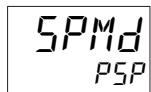
This procedure shows how to set the parameter to the program SP.

**Operating Procedure**

<p><b>1</b> Press the  Key several times in the Adjustment Level to select the SP Mode parameter.</p>	<p>Adjustment Level</p>  <p>SP Mode</p>
<p><b>2</b> Press the  or  Key to set <i>PSP</i> (program SP). The default is <i>PSP</i> (program SP).</p>	

**4-7-5 Creating the Program**

To create the program, you set parameters in the Program Setting Level.

**Set the Program Number parameter.**

- Display Program Selection

**Set the Number of Segments Used parameter.**

- Number of Segments Used

**Set the Segment Number parameter.**

- Display Segment Selection

**Set the segments.**

- Segment n Format (for rate of rise programming)
- Segment n SP
- Segment n Slope (for rate of rise programming)
- Segment n Time

\* The upper limit of “n” is determined by the Number of Segments Used parameter.

**Set the program.**

- PID Set No.
- Alarm Value

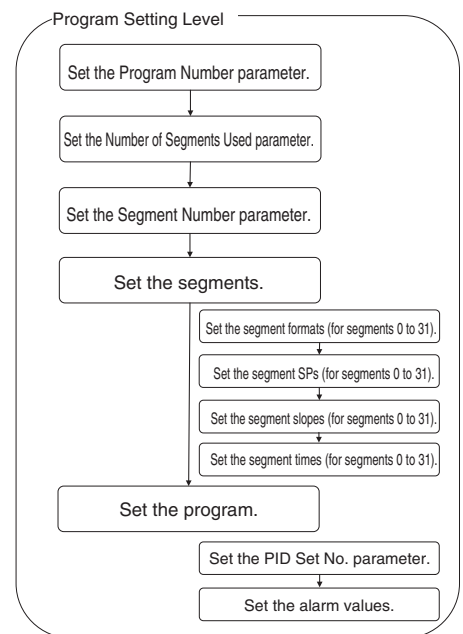

**Setting the Program Number Parameter**

Set the parameter to the number of the program to edit. When you change levels, the parameter for the currently selected program number is displayed.

● **Related Parameters**



Parameter name	Display	Setting range	Default	Level
Display Program Selection	<i>d.PRG</i>	0 to 7	*	Program Setting Level

\*Number of program currently used for control.

### ● Setting Example

This procedure shows how to select program 0.

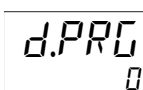
#### Operating Procedure

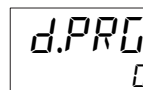
<b>1</b> Select the Display Program Selection parameter in Program Setting Level.	Program Setting Level  Display Program Selection
<b>2</b> Press the  or  Key to select 0. The default is the number of the currently executing program.	

## Setting the Number of Segments Used

This parameter specifies the number of segments to use in the program.



### ● Related Parameters

Parameter name	Display	Setting range	Default	Level
Number of Segments Used:	S-N $\bar{0}$	1 to 32	8	Program Setting Level

### ● Setting Example

The following procedure shows how to set four segments (i.e., segments 0 to 3 will be used).

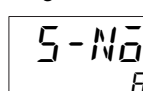
#### Operating Procedure

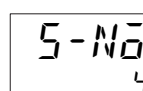
<b>1</b> Press the  Key several times in the Program Setting Level to select the Number of Segments Used parameter.	Program Setting Level  Number of Segments Used
<b>2</b> Press the  or  Key to set 4. The default is 8.	

## Setting the Segment Number Parameter

Set the parameter to the number of the segment to edit. When you change the display, *END* (do not edit segment parameters) is displayed.

### ● Related Parameters

Parameter name	Display	Setting range	Default	Level
Display Segment Selection	d.SEG	0 to 31	END*	Program Setting Level





\*If you move from the PV/SP display by pressing the  Key for one second, the current segment number is displayed.

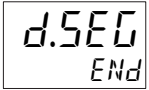

### ● Setting Example

This procedure shows how to select segment 0.

#### Operating Procedure

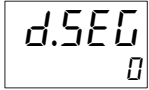
<p><b>1</b> Press the  Key several times in the Program Setting Level to select the Display Segment Selection parameter.</p>	<p>Program Setting Level</p>  <p>Display Segment Selection</p>
<p><b>2</b> Press the  or  Key to select 0. The default is <i>END</i>. * If anything other than <i>END</i> is selected and you press the  Key, the first segment parameter for the specified segment number is displayed.</p>	

## Setting the Segment Format Parameter (for Rate of Rise Programming)

This parameter sets the segment format for the specified segment number.



### ● Related Parameters

Parameter name	Setting range	Default	Level
Segment n Format	<i>RAMP</i> : Ramp <i>SOAK</i> : Soak <i>SLEEP</i> : Step	<i>RAMP</i>	Program Setting Level

### ● Setting Example

The following example shows how to set a ramp segment.

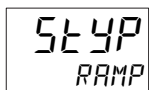
#### Operating Procedure

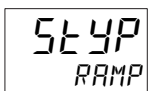
<p><b>1</b> Specify a segment number for the Display Segment Selection parameter and press the  Key several times to select the Segment Format parameter.</p>	<p>Program Setting Level</p>  <p>Segment 0 Format</p>
<p><b>2</b> Press the  or  Key to set <i>RAMP</i> (ramp). The default is <i>RAMP</i> (ramp).</p>	

## Setting the Segment SP Parameter

This parameter sets the SP for the specified segment number.





### ● Related Parameters

Parameter name	Display	Setting range	Unit	Default	Level
Segment n SP	<i>SP</i>	SP lower limit to SP upper limit	EU	0	Program Setting Level

### ● Setting Example

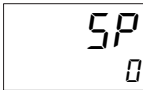
The following example shows how to set 50.

#### Operating Procedure

<b>1</b> Specify a segment number for the Display Segment Selection parameter and press the  Key several times to select the Segment SP parameter.	Program Setting Level  Segment 0 set point
<b>2</b> Press the  or  Key to set 50 (50°C). The default is 0.	

## Setting the Segment Slope Parameter (for Rate of Rise Programming)

This parameter sets the segment slope for the specified segment number.





### ● Related Parameters

Parameter name	Display	Setting range	Unit	Default	Level
Segment n Slope	PR	0 to 9999	EU/Time Unit of Ramp Rate	0	Program Setting Level

### ● Setting Example

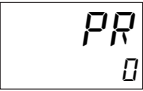
The following example shows how to set 2.

#### Operating Procedure

<b>1</b> Press the  Key several times from the Display Segment Selection parameter to select the Segment 1 Slope parameter.	Program Setting Level  Segment 1 Slope
<b>2</b> Press the  or  Key to select 2. The default is 0.	

## Setting the Segment Time

This parameter sets the segment time for the specified segment number.

### ● Related Parameters





Parameter name	Display	Setting range	Unit	Default	Level
Segment n Time	ELME	0.00 to 99.99	Hours and minutes, or minutes and seconds*	0.00	Program Setting Level

\*The unit is set in the Program Time Unit parameter (default: H-M (hours and minutes))

### ● Setting Example

The following example shows how to set 0.40.

#### Operating Procedure

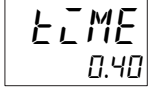
<b>1</b> Specify a segment number for the Display Segment Selection parameter and press the  Key several times to select the Segment Time parameter.	Program Setting Level 
<b>2</b> Press the  or  Key to set 0.40. The default is 0.00.	

## Setting the PID Set No. Parameter

This parameter specifies the PID set to use for the program.



### ● Related Parameters

Parameter name	Display	Setting range	Default	Level
PID Set No.	PID	0: Automatic selection 1 to 8: PID set number	1	Program Setting Level

### ● Setting Example

The following example shows how to set the PID set number to 2.

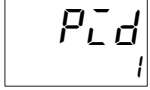
#### Operating Procedure

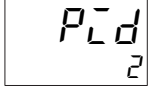
<b>1</b> Press the  Key several times in the Program Setting Level to select the PID Set No. parameter.	Program Setting Level 
<b>2</b> Press the  or  Key to set 2. The default is 1.	

## Setting the Alarm Value Parameter

Set the alarm value for the alarm to use.



### ● Related Parameters

Parameter name	Display	Setting range	Default	Level
Alarm Value 1 to 4	AL - 1 to 4	- 9999 to 9999	0	Program Setting Level

### ● Setting Example

The following example shows how to set alarm value 1 to 30°C.

#### Operating Procedure

<p><b>1</b> Press the  Key several times in the Program Setting Level to select the Alarm Value 1 parameter.</p>	<p>Program Setting Level</p> <div style="border: 1px solid black; padding: 5px; display: inline-block;"> <p>AL - 1</p> <p>0</p> </div> Alarm Value 1
<p><b>2</b> Press the  or  Key to select 30. The default is 0.</p>	<div style="border: 1px solid black; padding: 5px; display: inline-block;"> <p>AL - 1</p> <p>30</p> </div>

## 4-7-6 Changing Programs during Operation

The temperature vector will change if the program is changed during operation. The following sections show how the temperature vector will be changed.

### ● Step Time Programming

- Changing the SP

If the SP is changed during a segment, the present SP will move in a straight line with the changed SP as the target point.

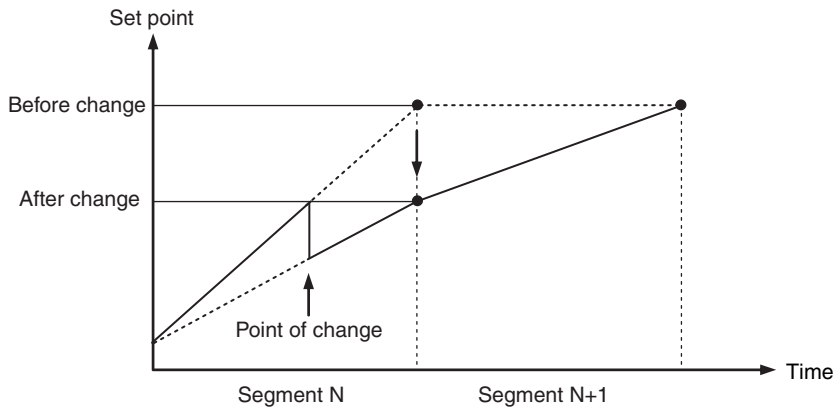

- Changing the Time

If the time is changed during a segment, the slope of the line along which the present SP moves will change because the time taken to reach the target will change.

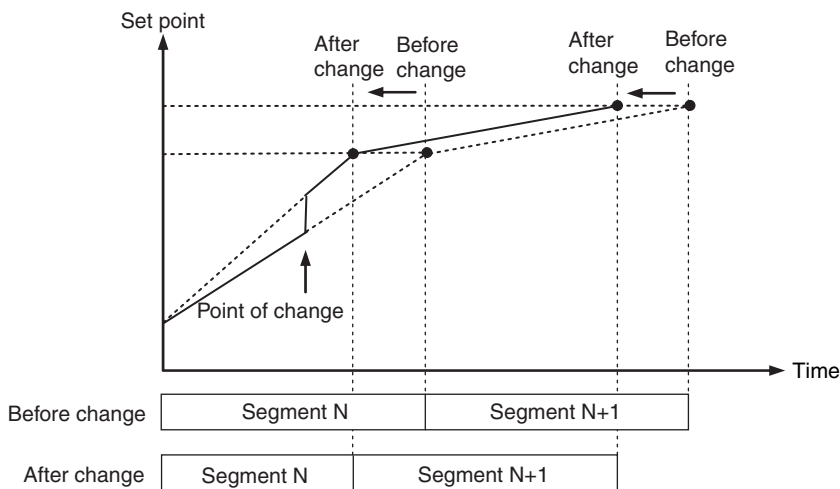

If the segment time after the change is shorter than the elapsed segment time, the program will immediately move to the next segment.

● **Rate of Rise Programming**

- If the rate of rise is changed during a segment, both the slope of the present SP and the segment time for the ramp period will change.

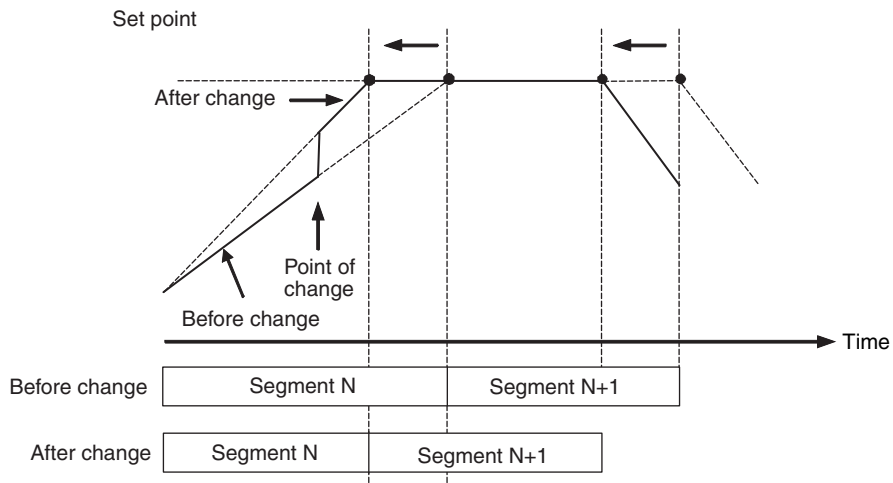

- If the SP is changed during a segment, the segment time for the ramp period will change.
- If the time is changed during a segment, the segment time for the soak period will change.

## 4-8 Setting the Fixed SP

You can set a fixed SP for the following purposes.

- To perform fixed SP operation (i.e., control with a fixed SP)
- To specify the starting point for autotuning all PID sets (i.e., the SP for the first execution of autotuning)

For details on autotuning all PID sets, refer to 5-14-1 Autotuning All PID Sets (Autotuning).

### 4-8-1 Fixed SP Setting Methods

There are the following two ways that you can use to set a fixed SP.

Method 1: Change the Fixed SP (*F5P*) parameter in Adjustment Level.





Method 2: Change the SP parameter in Operation Level during fixed SP operation.\*

\* The new SP for method 2 is saved in the Fixed SP (*F5P*) parameter in Adjustment Level.

#### Method 1: Changing the Fixed SP Parameter in Adjustment Level

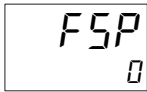
This procedure sets the Fixed SP (*F5P*) parameter to 200°C.

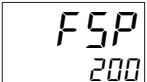

##### Operating Procedure

<p><b>1</b> Press the  Key several times in the Adjustment Level to select the Fixed SP (<i>F5P</i>) parameter.</p>	<p>Adjustment Level</p> 
<p><b>2</b> Press the  or  Key to set the fixed SP to 200. The default is .</p>	

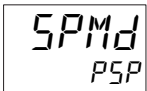

#### Method 2: Changing the SP Parameter in Operation Level during Fixed SP Control (While the *F5P* Operation Display Is Lit)

The following procedures set Fixed SP Mode (the *F5P* operation display will light).

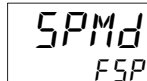
Reset Operation = Stop Control



<p><b>1</b> Press the  Key several times in the Adjustment Level to select the SP Mode parameter.</p>	<p>Adjustment Level</p> 
<p><b>2</b> Press the  Key to select <i>F5P</i>. Fixed SP Mode is entered (the <i>F5P</i> operation display will light).</p>	

Reset Operation = Fixed SP Operation

<p><b>1</b> Press the  Key several times in the Operation Level to display the Run/Reset parameter.</p>	<p>Adjustment Level</p> <div style="border: 1px solid black; padding: 5px; display: inline-block;"> <p>R-R RSt</p> </div> <p>Run/Reset</p>
<p><b>2</b> Press the  Key to select RSt. The default is RSt. * Fixed SP Mode is entered (the FSP operation display will light).</p>	<div style="border: 1px solid black; padding: 5px; display: inline-block;"> <p>R-R RSt</p> </div>

The following procedure sets the set point to 200°C.

**Operating Procedure**

<p><b>1</b> Select the Process Value/Set Point 1/2 parameter in the Operation Level.</p>	<p>Adjustment Level</p> <div style="border: 1px solid black; padding: 5px; display: inline-block;"> <p>25 0</p> </div> <p>Process Value/Set Point (1) (2)</p>
<p><b>2</b> Press the  or  Key to set the SP to 200. The default is 0.</p>	<div style="border: 1px solid black; padding: 5px; display: inline-block;"> <p>25 200</p> </div>

● **Related Parameters**

Parameter name	Display	Setting range	Unit	Level
SP Mode	S <sub>PMd</sub>	PSP: Program SP Mode FSP: Fixed SP Mode	---	Adjustment Level
Fixed SP	FSP	SP lower limit to SP upper limit	EU	
Reset Operation	R <sub>LSM</sub>	StōP: Stop control FSP: Fixed SP operation	---	Initial Setting Level



## 4-9 Determining PID Constants (Autotuning and Manual Setting)

---

There are two types of autotuning for the E5□C-T.

### ● Normal Autotuning

- Autotuning is executed for the currently selected PID set.
- The current SP when autotuning is specified is used as the autotuning SP.
- You can use normal autotuning when you specify the PID set for each selected program, or when you automatically select PID sets according to application temperature zones.

### ● Autotuning All PID Sets (Autotuning)







- You can automatically execute autotuning in order for more than one PID set.
- The SP for autotuning each PID set is the fixed SP for the first execution of autotuning, the mean value of each PID set temperature zone for the middle zones, and the All PID AT Upper Limit SP for the last execution of autotuning.
- You can use this type of autotuning only when you use automatic selection of PID sets according to temperature zones.
- For details on autotuning all PID sets, refer to *5-14 Determining PID Constants for PID Sets (Autotuning for All PID Sets)*.

## 4-9-1 AT (Auto-tuning)



- When AT is executed, the optimum PID constants for the set point at that time are set automatically. A method (called the limit cycle method) for forcibly changing the manipulated variable and finding the characteristics of the control object is employed.
- Either 40% AT or 100% AT can be selected depending on the width of MV variation in the limit cycle. For the AT Execute/Cancel parameter, specify  $AT-2$  (100% AT),  $AT-1$  (40% AT),  $ALL100$  (All PID 100% AT), or  $ALL40$  (All PID 40% AT). To cancel AT, specify  $OFF$  (AT cancel).
- Only 100% autotuning is supported for heating and cooling control or floating position-proportional control.
- If the Heating/Cooling Tuning Method parameter is set to any value other than 0 (same as heating control), the PID constants are set automatically for both heating control and cooling control.
- Autotuning cannot be executed while the program is reset (if the reset operation is set to stop control), while on standby (if the reset operation is set to stop control), during manual operation, and during ON/OFF control.
- The following operations are not possible during autotuning: changing settings, hold/clear hold, and segment operations, such as advance operations.
- Autotuning will stop if the Run/Reset parameter is set to Reset and the Reset Operation parameter is set to stop control, or if you switch to manual operation.
- The following operation will be performed if the Reset Operation parameter is set to fixed SP operation.
  - If the Run/Reset parameter is changed to Reset during autotuning, the present SP will be changed to the fixed SP after autotuning has been completed.
  - If autotuning is executed while the Run/Reset parameter is set to Reset and the Run/Reset parameter is changed to Run during autotuning execution, the program will be started after completing autotuning.
- The results of autotuning are reflected in the Proportional Band (P), Integral Time (I), and Derivative Time (D) parameters of the PID set where autotuning was started. For details on PID sets, refer to 5-13-1 *PID Sets*

## Adjustment Level

 8.0	Proportional Band	 8.0	Proportional Band (Cooling)
 233	Integral Time	 233	Integral Time (Cooling)
 40	Derivative Time	 40	Derivative Time (Cooling)

## ● AT Operations

AT is started when  $AE-2$  (100% AT),  $AE-1$  (40% AT)  $AE&AE$  (all PID 100% AT), or  $AE&A1$  (all PID 40% AT) is specified for the AT Execute/Cancel parameter.

The TUNE indicator will light during execution.

Only the Communications Writing, RUN/RESET, and AT Execution/Cancel parameters can be changed during AT execution. Other parameters cannot be changed.

## AT Calculated Gain

The AT Calculated Gain parameter sets the gain for when PID values are calculated using AT. When emphasizing response, decrease the set value. When emphasizing stability, increase the set value.

## AT Hysteresis

The AT Hysteresis parameter sets the hysteresis when switching ON and OFF for the limit cycle operation during auto-tuning.

## Limit Cycle MV Amplitude

The Limit Cycle MV Amplitude parameter sets the MV amplitude for limit cycle operation during auto-tuning.

\* This setting is disabled for 100% AT.

## ● 40% AT

- The width of MV variation in the limit cycle can be changed in the Limit Cycle MV Amplitude parameter, but the AT execution time may be longer than for 100% AT. The limit cycle timing varies according to whether the deviation (DV) at the start of auto-tuning execution is less than 10% FS.

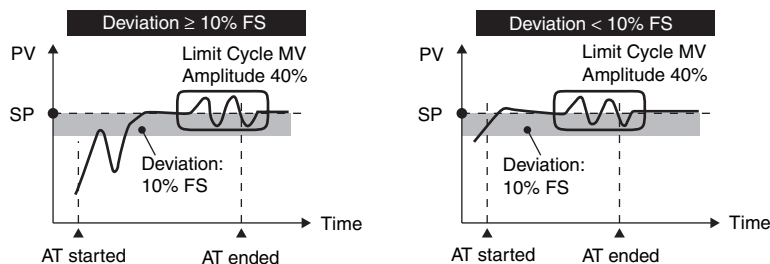

## ● 100% AT

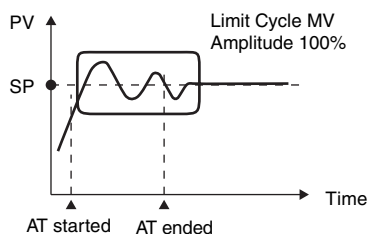

- Operation will be as shown in the following diagram, regardless of the deviation (DV) at the start of AT execution. To shorten the AT execution time, select 100% AT.



\* The Limit Cycle MV Amplitude parameter is disabled.

The 100% autotuning is executed.

**Operating Procedure**

<p><b>1</b> Press the  Key several times in the Adjustment Level to display <i>RT</i> (AT Execute/Cancel).</p>	<p>Adjustment Level</p> <div style="border: 1px solid black; padding: 5px; display: inline-block;"> <p><i>RT</i> <i>OFF</i></p> </div> <p>AT Execute/Cancel</p>
<p><b>2</b> Press the  or  Key to select <i>RT-2</i> (100% AT execute). * The TUNE indicator will light during autotuning.</p>	<div style="border: 1px solid black; padding: 5px; display: inline-block;"> <p><i>RT</i> <i>RT-2</i></p> </div>
<p><b>3</b> When AT ends, the AT Execute/Cancel parameter is set to <i>OFF</i>.</p>	<p>Adjustment Level</p> <div style="border: 1px solid black; padding: 5px; display: inline-block;"> <p><i>RT</i> <i>OFF</i></p> </div> <p>AT Execute/Cancel</p>

● **All PID 100% AT and All PID 40% AT**

- For details on All PID 100% AT and All PID 40% AT, refer to 5-14 *Determining PID Constants for PID Sets (Autotuning for All PID Sets)*.

**4-9-2 RT (Robust Tuning) (Used for Autotuning)**

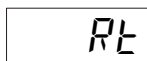

- When autotuning is executed with RT selected, PID constants are automatically set that make it hard for control performance to degenerate even when control object characteristics change.
- RT can be set in the Advanced Function Setting Level when PID control has been set.
- The RT mode cannot be selected while an analog input is set.
- Selecting the RT mode in the following cases will help to prevent hunting from occurring.
  - When the set temperature is not constant and is changed in a wide range
  - When there are large variations in ambient temperatures due to factors such as seasonal changes or differences between day and night temperatures
  - When there are large variations in ambient wind conditions and air flow
  - When heater characteristics change depending on the temperature
  - When an actuator with disproportional I/O, such as a phase-control-type power regulator, is used
  - When a rapidly heating heater is used
  - When the control object or sensor has much loss time
  - When hunting occurs in normal mode for any reason
    - \* PID constants are initialized to the factory settings by switching to RT mode.
    - \* When the RT mode is selected, the Integral/Derivative Time Unit parameter changes to 0.1 s.

### ● RT Features

- Even if hunting occurs for PID constants when autotuning is executed in normal mode, it is less likely to occur when autotuning is executed in RT Mode.

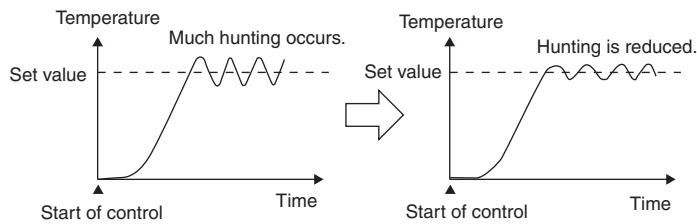

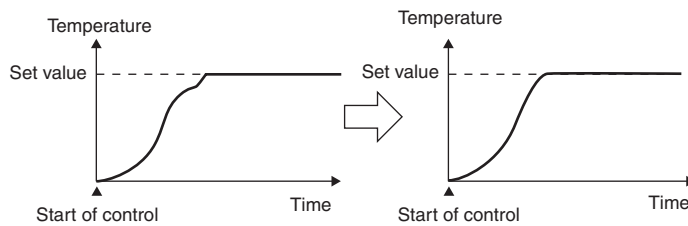

- When the temperature (PV) falls short of the set point for the PID constants when using autotuning in normal mode, executing autotuning in RT Mode tends to improve performance.



- When the manipulated variable (MV) is saturated, the amount of overshooting may be somewhat higher in comparison to PID control based on autotuning in normal mode.

This procedure selects RT mode.

#### Operating Procedure

<p><b>1</b> Press the  Key several times in the Advanced Function Setting Level to display <i>RT</i> (RT: robust tuning).</p>	<p>Advanced Function Setting Level</p> <div style="border: 1px solid black; padding: 5px; display: inline-block;"> <i>RT</i>  <del>OFF</del> </div> <p style="margin-left: 20px;">RT</p>
<p><b>2</b> Press the  or  Key to select <i>ON</i> (RT ON). The default is <del>OFF</del>.</p>	<div style="border: 1px solid black; padding: 5px; display: inline-block;"> <i>RT</i>  <del>ON</del> </div>











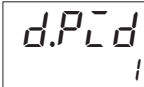



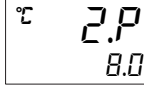

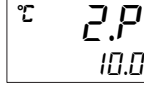
### 4-9-3 Manual Setup

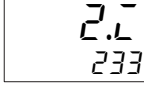
You can manually set individual PID constants in the Proportional Band, Integral Time, and Derivative Time parameters in the PID Setting Level after you select the PID set number with the Display PID Selection parameter.

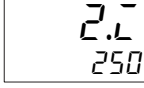
If you change the setting of the Proportional Band, Integral Time, and Derivative Time parameters in the Adjustment Level, the new settings are saved in the Proportional Band, Integral Time, and Derivative Time parameters for the currently selected PID set.

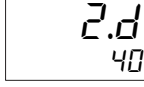
For details on PID sets, refer to *5-13-1 PID Sets*.

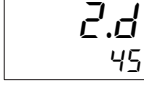
The following procedure sets the PID 2 Proportional Band parameter to 10.0, the PID 2 Integral Time parameter to 250, and the PID 2 Derivative Time parameter to 45.

<p><b>1</b> Press the  Key three times for less than 1 second each time in the Operation Level. The display will change to the PID Setting Level.</p>	<p>PID Setting Level</p>  <p>Display PID Selection</p>
<p><b>2</b> Press the  or  Key to set the parameter to 2.</p>	
<p><b>3</b> Press the  Key to select the PID 2 Proportional Band parameter.</p>	 <p>Proportional Band</p>
<p><b>4</b> Press the  or  Key to set the parameter to 10.0.</p>	
<p><b>5</b> Press the  Key to select the PID 2 Integral Time parameter.</p>	 <p>Integral Time</p>
<p><b>6</b> Press the  or  Key to set 250.</p>	
<p><b>7</b> Press the  Key to select the PID 2 Derivative Time parameter.</p>	 <p>Derivative Time</p>
<p><b>8</b> Press the  or  Key to set 45.</p>	
<p><b>9</b> Press the  Key to return to the Operation Level.</p>	



#### Additional Information

##### Proportional Action

When PID constants I (integral time) and D (derivative time) are set to 0, control is executed according to proportional action. As the default, the center value of the proportional band becomes the set point.

Related parameter: Manual Reset Value (Adjustment Level)

### When P (Proportional Band) Is Adjusted

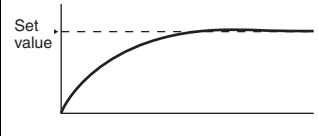
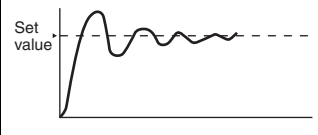
Increased	 A graph with a vertical axis labeled 'Set value' and a horizontal axis. A dashed horizontal line represents the set value. A solid curve starts at the origin and rises smoothly, asymptotically approaching the set value line without overshooting.	The curve rises gradually, and a long stabilization time is created, but overshooting is prevented.
Decreased	 A graph with a vertical axis labeled 'Set value' and a horizontal axis. A dashed horizontal line represents the set value. A solid curve starts at the origin, rises sharply, overshoots the set value, and then oscillates around the set value line before stabilizing.	Overshooting and hunting occur, but the set value is quickly reached and the temperature stabilizes.

### When I (Integral Time) Is Adjusted

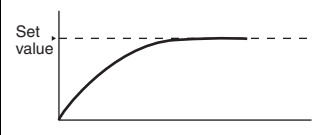
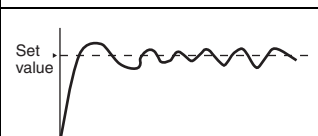
Increased	 A graph with a vertical axis labeled 'Set value' and a horizontal axis. A dashed horizontal line represents the set value. A solid curve starts at the origin and rises very slowly, taking a long time to reach the set value line.	It takes a long time to reach the set point. It takes time to achieve a stable state, but overshooting, undershooting, and hunting are reduced.
Decreased	 A graph with a vertical axis labeled 'Set value' and a horizontal axis. A dashed horizontal line represents the set value. A solid curve starts at the origin, rises sharply, overshoots the set value, and then oscillates around the set value line.	Overshooting and undershooting occur. Hunting occurs. The Controller starts up faster.

### When D (Derivative Time) Is Adjusted

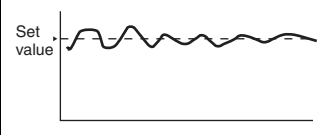
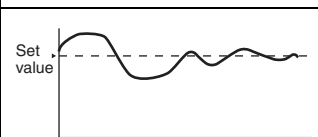
Increased	 A graph with a vertical axis labeled 'Set value' and a horizontal axis. A dashed horizontal line represents the set value. A solid curve starts at the origin, rises to the set value, and then oscillates around the set value line.	Overshooting, undershooting, and stabilization times are reduced, but fine hunting occurs on changes in the curve itself.
Decreased	 A graph with a vertical axis labeled 'Set value' and a horizontal axis. A dashed horizontal line represents the set value. A solid curve starts at the origin, rises sharply, overshoots the set value, and then oscillates around the set value line.	Overshooting and undershooting increase, and it takes time to return to the set point.

## 4-10 Alarm Outputs

- You can use alarms on models with auxiliary outputs. For relay outputs or voltage outputs (for driving SSRs), alarms can also be used by setting the Control Output 1 Assignment or Control Output 2 Assignment parameter to any of the alarms from alarm 1 to 4. The alarm output condition is determined by a combination of the alarm type, alarm value, alarm hysteresis, and the standby sequence. For details, refer to *4-11 Alarm Hysteresis*.
- This section describes the Alarm Type, Alarm Value, Alarm Upper Limit and Alarm Lower Limit parameters.

### 4-10-1 Alarm Types

 Alarm 1 Type

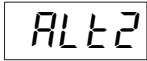
 Alarm 2 Type

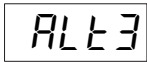
 Alarm 3 Type

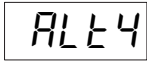
 Alarm 4 Type

- Set the alarm type independently for each alarm in the Alarm 1 to 4 Type parameters in the Initial Setting Level.
- The alarms that can be set are listed in the following table.
- You can use an LBA (12) only for alarm 1. You cannot use an LBA on a Position-proportional Model.

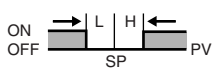
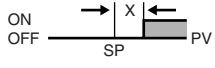
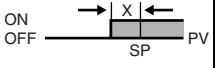
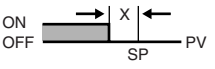
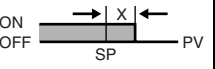
Set value	Alarm type	Alarm output operation		Description of function
		When alarm value X is positive	When alarm value X is negative	
0	Alarm function OFF	Output OFF		No alarm
1	Upper- and lower-limit*1		*2	Set the upward deviation in the set point for the alarm upper limit (H) and the lower deviation in the set point for the alarm lower limit (L). The alarm is ON when the PV is outside this deviation range.
2 (default)	Upper-limit			Set the upward deviation in the set point by setting the alarm value (X). The alarm is ON when the PV is higher than the SP by the deviation or more.
3	Lower-limit			Set the downward deviation in the set point by setting the alarm value (X). The alarm is ON when the PV is lower than the SP by the deviation or more.



Set value	Alarm type	Alarm output operation		Description of function
		When alarm value X is positive	When alarm value X is negative	
4	Upper- and lower-limit range*1		*3	Set the upward deviation in the set point for the alarm upper limit (H) and the lower deviation in the set point for the alarm lower limit (L). The alarm is ON when the PV is inside this deviation range.
5	Upper- and lower-limit with standby sequence*1		*4	A standby sequence is added to the upper- and lower-limit alarm (1).*6
6	Upper-limit with standby sequence			A standby sequence is added to the upper-limit alarm (2).*6
7	Lower-limit with standby sequence			A standby sequence is added to the lower-limit alarm (3).*6
8	Absolute-value upper-limit			The alarm will turn ON if the process value is larger than the alarm value (X) regardless of the set point.
9	Absolute-value lower-limit			The alarm will turn ON if the process value is smaller than the alarm value (X) regardless of the set point.
10	Absolute-value upper-limit with standby sequence			A standby sequence is added to the absolute-value upper-limit alarm (8).*6
11	Absolute-value lower-limit with standby sequence			A standby sequence is added to the absolute-value lower-limit alarm (9).*6
12	LBA (alarm 1 type only)			*7
13	PV change rate alarm			*8
14	SP absolute-value upper-limit alarm			This alarm type turns ON the alarm when the set point (SP) is higher than the alarm value (X).
15	SP absolute-value lower-limit alarm			This alarm type turns ON the alarm when the set point (SP) is lower than the alarm value (X).
16	MV absolute-value upper-limit alarm*9	Standard Control		This alarm type turns ON the alarm when the manipulated variable (MV) is higher than the alarm value (X).
		Heating/Cooling Control (Heating MV)		
		Heating/Cooling Control (Cooling MV)	Always ON	

Set value	Alarm type	Alarm output operation		Description of function
		When alarm value X is positive	When alarm value X is negative	
17	MV absolute-value lower-limit alarm*9	Standard Control 	Standard Control 	This alarm type turns ON the alarm when the manipulated variable (MV) is lower than the alarm value (X).
		Heating/Cooling Control (Cooling MV) 	Heating/Cooling Control (Cooling MV) Always ON	

\*1 With set values 1, 4, and 5, the upper- and lower-limit values can be set independently for each alarm type, and are expressed as “L” and “H.”

\*2 Set value: 1 (Upper- and lower-limit alarm)

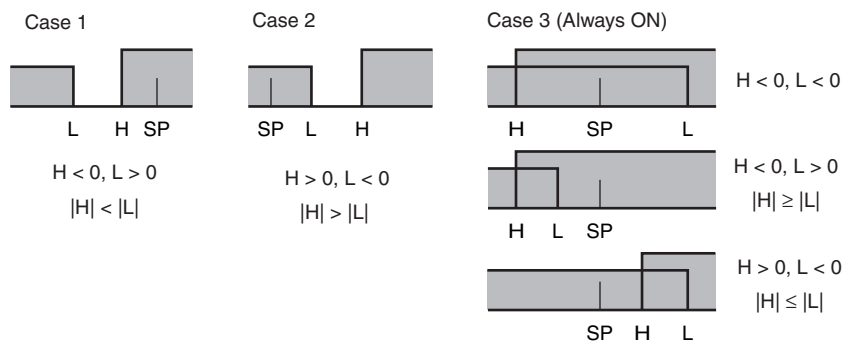

\*3 Set value: 4 (Upper- and lower-limit range)

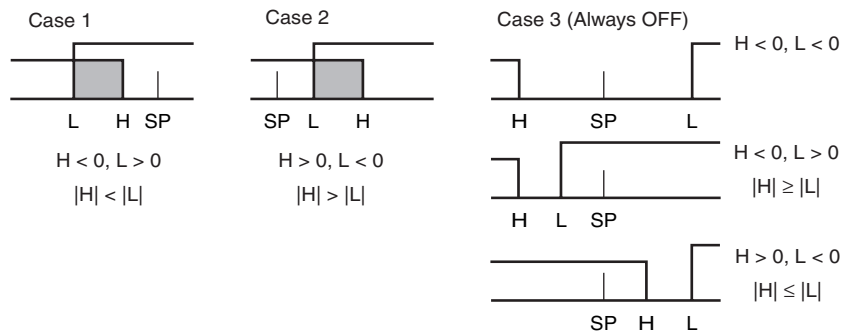

\*4 Set value: 5 (Upper- and lower-limit alarm with standby sequence)

- For the upper- and lower-limit alarms in cases 1 and 2 above, the alarm is always OFF if upper- and lower-limit hysteresis overlaps.
- In case 3, the alarm is always OFF.

\*5 Set value: 5 (Upper- and lower-limit alarm with standby sequence)

- The alarm is always OFF if upper- and lower-limit hysteresis overlaps.

\*6 Refer to *Standby Sequence Reset* on page 6-83 for information on the operation of the standby sequence.

\*7 Refer to *5-10-1 Loop Burnout Alarm (LBA)*.

\*8 Refer to *PV Change Rate Alarm* on page 4-60.

\*9 When heating/cooling control is performed, the MV absolute-value upper-limit alarm functions only for the heating operation and the MV absolute-value lower-limit alarm functions only for the cooling operation.

- If the Controller is equipped with HB/HS alarm detection, the Alarm 1 Type is not displayed for the default settings. To use alarm 1, set an output assignment to alarm 1. (Refer to *4-6-3 Assigned Output Functions (Assigning Control Outputs Is Not Supported for Position-proportional Models.)*.)
- When the Reset Operation parameter is set to stop control and operation being reset in Program SP Mode or operation is on standby, the applicable SP for a deviation alarm (alarm type 1 to 7) is the SP for segment 0.

- With rate of rise programming, if the Reset Operation parameter is set to stop control and the Segment Type parameter of segment 0 is set to Soak, the applicable SP for a deviation alarm (alarm type 1 to 7) is the PV.

### 4-10-2 Alarm Values

 Alarm Lower Limit Value

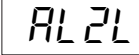

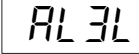

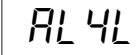

 Alarm Upper Limit Value

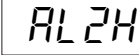

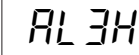

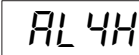

 Alarm Value

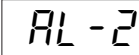

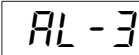

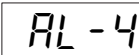

- Alarm values are indicated by “X” in the table on the previous page. When the upper and lower limits are set independently, “H” is displayed for upper limit values, and “L” is displayed for lower limit values.
- To set the alarm value upper and lower limits for deviation, set the upper and lower limits in each of the Alarm 1 to 4 Upper Limit, and Alarm 1 to 4 Lower Limit parameters in the Operation Level.





This procedure sets alarm 1 as an upper-limit alarm. The alarm is output when the process value (PV) exceeds the set point (SP) by 10°C. (In this example, the temperature unit is °C.)

Alarm 1 type = 2 (Upper-limit alarm)

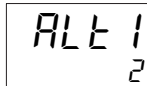

Alarm value 1= 10

#### Operating Procedure

- Selecting the Alarm 1 Type

<p><b>1</b> Press the  Key several times in the Initial Setting Level to display <i>AL 1</i> (Alarm 1 Type).*</p>	<p>Initial Setting Level</p>  Alarm 1 Type
<p><b>2</b> Press the  or  Key to set the set value to 2. The default is 2 (upper-limit alarm).</p>	

- Setting the Alarm Value

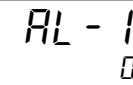
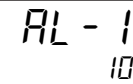
<p><b>1</b> Press the <b>[Enter]</b> Key for less than 1 second in the Operation Level. The display will change to the Program Setting Level.</p>	<p>Program Setting Level</p>  <p>Display Program Selection</p>
<p><b>2</b> Press the <b>[Up]</b> or <b>[Down]</b> Key to set 1.</p>	
<p><b>3</b> Press <b>[Enter]</b> Key several times to select the Alarm Value 1 parameter.</p>	 <p>Alarm Value 1</p>
<p><b>4</b> Use the <b>[Up]</b> Key to set the parameter to 10.</p>	

\* If the Controller is equipped with HB/HS alarm detection, the Alarm 1 Type is not displayed for the default settings. To use alarm 1, set an output assignment to alarm 1. For details, refer to 4-6-3 Assigned Output Functions (Assigning Control Outputs Is Not Supported for Position-proportional Models.).

● **PV Change Rate Alarm**

The change width can be found for PV input values in any set period. Differences with previous values in each set period are calculated, and an alarm is output if the result exceeds the alarm value. The PV rate of change calculation period can be set in units of 50 ms.

If a positive value is set for the alarm value, the PV will operate as a change rate alarm in the rising direction. If a negative value is set, the PV will operate as a change rate alarm in the falling direction.



**Precautions for Correct Use**

If a shorter PV rate of change calculation period is set, outputs set for the PV change rate alarm function may repeatedly turn ON and OFF for a short period of time. It is therefore recommended that the PV change rate alarm be used with the alarm latch turned ON.

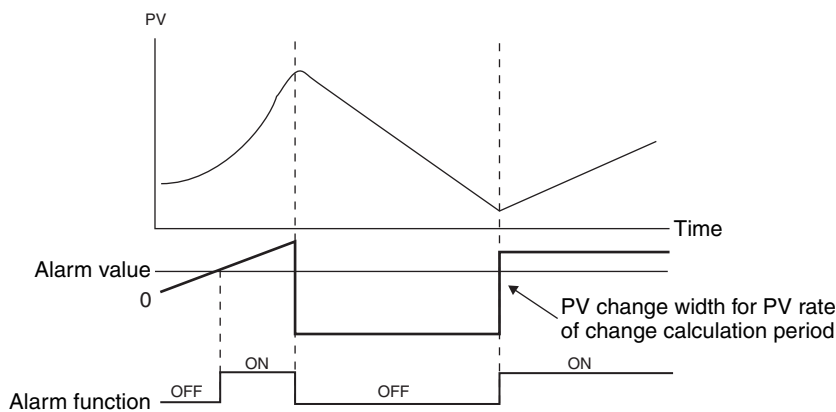

Parameter name	Setting range	Unit	Default
PV Rate of Change Calculation Period	1 to 999	Sampling cycle	20 (1 s)

● **SP Alarms**

You can set an SP absolute-value upper-limit or SP absolute-value lower-limit alarm for the set point (SP).

The alarm point is set in the corresponding alarm value parameter. The Alarm SP Selection parameter is used to specify the alarm for either the ramp SP or the target SP.

The corresponding alarm hysteresis setting is also valid.

SP absolute-value upper-limit alarm	SP absolute-value lower-limit alarm
<p>Example:</p> <p>The alarm output is ON while the SP is equal to or higher than the set value.</p>	<p>Example:</p> <p>The alarm output is ON while the SP is equal to or lower than the set value.</p>

● **MV Alarms**

You can set an MV absolute-value upper-limit or MV absolute-value lower-limit alarm for the manipulated value (MV).

The alarm point is set in the corresponding alarm value parameter. The corresponding alarm hysteresis setting is also valid.

MV absolute-value upper-limit alarm	MV absolute-value lower-limit alarm
<p>Example for Standard Control:</p> <p>The alarm output is ON while the MV is equal to or higher than the set value.</p>	<p>Example for Standard Control:</p> <p>The alarm output is ON while the MV is equal to or lower than the set value.</p>

## 4-11 Alarm Hysteresis

- The hysteresis of alarm outputs when alarms are switched ON/OFF can be set as follows:

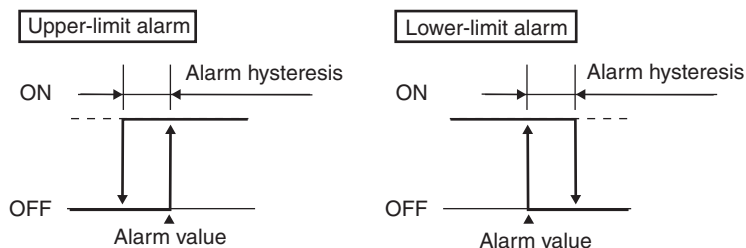

- Alarm hysteresis is set independently for each alarm in the Alarm Hysteresis 1 to Alarm Hysteresis 4 parameters (Initial Setting Level).
- For all alarms except for MV alarms, the default is 0.2 (°C/°F) for temperature inputs and 0.02% FS for analog inputs. The default is 0.50(%) for MV alarms.

### 4-11-1 Standby Sequence

- The standby sequence can be used so that an alarm will not be output until the process value leaves the alarm range once and then enters it again.
  - For example, with a lower-limit alarm, the process value will normally be below the set point, i.e., within the alarm range, when the power supply is turned ON, causing an alarm to be output. If the lower-limit alarm with a standby sequence is selected, an alarm will not be output until the process value increases above the alarm set value, i.e., until it leaves the alarm range, and then falls back below the alarm set value.
- Restart**
    - The standby sequence is canceled when an alarm is output. It is, however, restarted later by the Standby Sequence Reset parameter (Advanced Function Setting Level). For details, refer to the Standby Sequence Reset parameter in *Section 6 Parameters*.

## 4-11-2 Alarm Latch

- The alarm latch can be used to keep the alarm output ON until the latch is canceled regardless of the temperature once the alarm output has turned ON.

Any of the following methods can be used to clear the alarm latch.

- Turn OFF the power supply. (The alarm latch is also cleared by switching to the Initial Setting Level, Communications Setting Level, Advanced Function Setting Level, or Calibration Level.)
- Use the PF Key.
- Use an event input.

For details on setting the PF Key, refer to 5-19 *Setting the PF Key*. For details on setting events, refer to 5-4 *Using Event Inputs*.

### ● Summary of Alarm Operation

The following figure summarizes the operation of alarms when the Alarm Type parameter is set to "lower-limit alarm with standby sequence" and "close in alarm" is set.

Alarm type: Lower-limit alarm with standby sequence

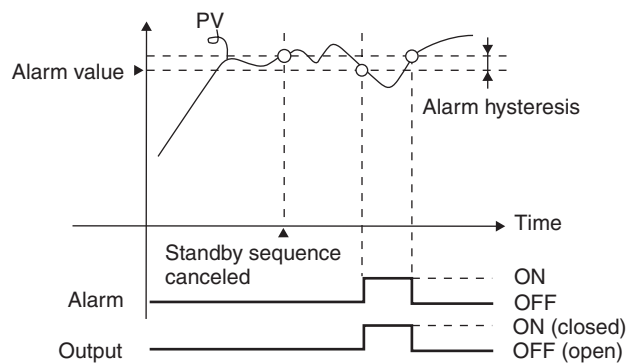

### Parameters

Display	Parameter	Description	Level
RLH*	Alarm 1 to 4 Hysteresis	Alarm	Initial Setting Level
RESL	Standby Sequence	Alarm	Advanced Function Setting Level

\* \* = 1 to 4

## 4-12 Using Heater Burnout (HB) and Heater Short (HS) Alarms (Not Supported for Position-proportional Models.)

These functions are supported for models that detect heater burnout (HB) and heater short (HS) alarms.

### 4-12-1 HB Alarm

#### ● What Is an HB Alarm?

An HB alarm is detected by measuring the heater current with a current transformer (CT) when the control output is ON. If the measured heater current is lower than the setting of the Heater Burnout Detection parameter, an alarm is output.

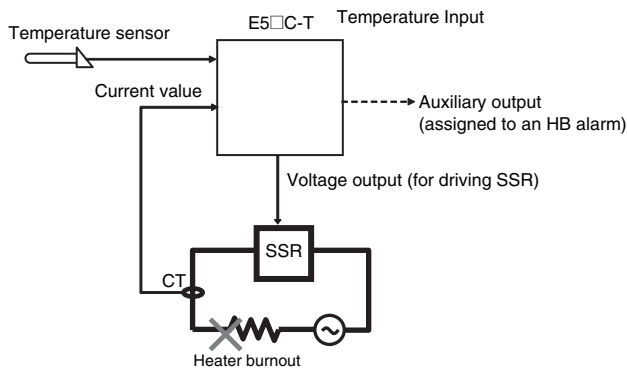

This alarm cannot be used for the cooling control output. With the default settings, the HB alarm is output on auxiliary output 1. You can use the output assignment parameters to change the output. You can use an integrated alarm to output an OR of alarms 1 to 4 and the other alarms. For details on the integrated alarm, refer to *5-8 OR Output of Alarms*.

#### ● Parameters

Parameter	No. 1 display	Value	No. 2 display	Level
HB ON/OFF	<i>HbU</i>	OFF or ON (default: ON)	$\bar{a}FF, \bar{a}N$	Advanced Function Setting Level
Heater Burnout Latch	<i>HbL</i>	OFF or ON (default: OFF)	$\bar{a}FF, \bar{a}N$	Adjustment Level
Heater Burnout Hysteresis	<i>HbH</i>	0.1 to 50.0 A (default: 0.1 A)	0.1 to 50.0	
Heater Burnout Detection 1 or 2 (alarm current)	<i>Hb1</i> <i>Hb2</i>	0.0 to 50.0 A (default: 0.0 A)	0.0 to 50.0	Adjustment Level
Heater Current 1 or 2 Value Monitor	<i>[t1]</i> <i>[t2]</i>	0.0 to 55.0 A	0.0 to 55.0	
Auxiliary Output 1 to 4 Assignment	<i>SUb 1</i> to <i>SUb 4</i>	HB: HB alarm or HA: Heater alarm	<i>Hb</i> or <i>HA</i>	Advanced Function Setting Level



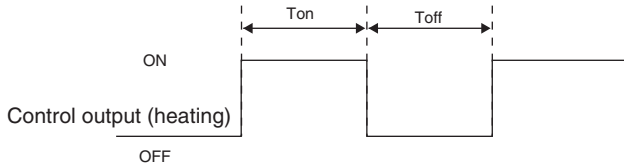

In the above diagram, power is considered to be ON (normal) if the heater current is greater than  $Hb1$  or  $Hb2$  (heater burnout detection current) during the  $T_{on}$  interval. The HB alarm will be OFF in this case. If the heater current is less than  $Hb1$  or  $Hb2$  (heater burnout detection current) during the  $T_{on}$  interval, the HB alarm will turn ON. Heater burnout is not detected if the ON time ( $T_{on}$ ) for the control output for heating is 100 ms or less (30 ms or less if the control period is 0.1 or 0.2 s). Heater burnouts are not detected in the following cases.

- Turn ON the heater power supply simultaneously or before turning ON the E5□C-T power supply. If the heater power supply is turned ON after turning ON the E5□C-T power supply, the HB alarm will be output.
- Control will be continued even when there is an HB alarm.
- The rated current may sometimes differ slightly from the actual current flowing to the heater. Use the Heater Current 1 Value Monitor and Heater Current 2 Value Monitor parameters to check the current during actual operation
- If there is little difference between the current in normal and abnormal states, detection may be unstable. To stabilize detection, set a current difference of at least 1.0 A for heaters lower than 10.0 A, and at least 2.5 A for heaters of 10.0 A or higher. If the heater current is too low, loop the load line several times through a CT, as shown in the following diagram. Looping it through once will double the detected current.

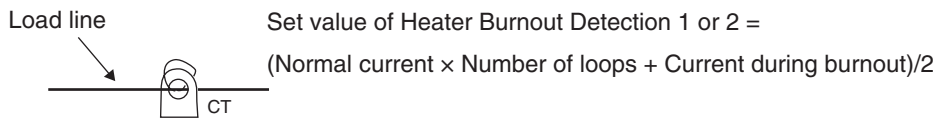



### ● Operating Procedure

Set the HB ON/OFF parameter in the Advanced Function Setting Level, and set the Heater Burnout Detection 1 parameter in the Adjustment Level.

Heater Burnout Detection 1 = 2.5

#### Operating Procedure

- Checking the HB ON/OFF Parameter Setting

<p><b>1</b> Press the  Key several times in the Advanced Function Setting Level to display <math>HbU</math> (HB ON/OFF).</p>	<p>Advanced Function Setting Level</p>  <p>HB ON/OFF</p>
<p><b>2</b> Check to see if the set value is <math>\bar{O}N</math> (enabled, default).</p>	

- Checking the Heater Current

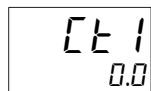
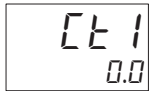
<p><b>1</b> Press the <b>☰</b> Key several times in the Adjustment Level to display <b>CT 1</b> (Heater Current 1 Value Monitor).</p>	<p>Adjustment Level</p>  <p>Heater Current 1 Value Monitor</p>
<p><b>2</b> Check the heater current from the CT input that is used to detect heater burnout. The monitoring range is 0.0 to 55.0 A.</p>	

- Setting Heater Burnout Detection

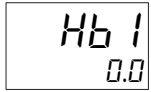
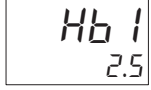
<p><b>1</b> Press the <b>☰</b> Key several times in the Adjustment Level to display <b>Hb 1</b> (Heater Burnout Detection 1).</p>	<p>Adjustment Level</p>  <p>Heater Burnout Detection 1</p>
<p><b>2</b> Press the <b>▲</b> or <b>▼</b> Key to set the set value to 2.5 Refer to 4-12-4 Calculating Detection Current Values when you set the value.</p>	

## 4-12-2 HS Alarm

### ● What Is an HS Alarm?

An HS alarm is detected by measuring the heater current with a current transformer (CT) when the control output is OFF. If the measured heater current is higher than the setting of the HS Alarm parameter, an alarm is output.

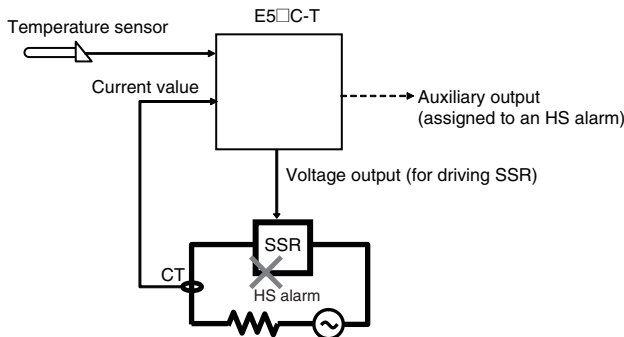

Control output (heating)	Power to heater	HS alarm output
OFF	Yes (HS alarm)	ON
	No (normal)	OFF

This alarm cannot be used for the cooling control output. With the default settings, the HS alarm is output on auxiliary output 1. You can use the output assignment parameters to change the output. You can use an integrated alarm to output an OR of alarms 1 to 4 and the other alarms. For details on the integrated alarm, refer to 5-8 OR Output of Alarms.

## ● Parameters

Parameter	No. 1 display	Value	No. 2 display	Level
HS Alarm Use	<i>HSU</i>	OFF or ON (default: ON)	<i>OFF, ON</i>	Advanced Function Setting Level
HS Alarm Latch	<i>HSL</i>	OFF or ON (default: OFF)	<i>OFF, ON</i>	
HS Alarm Hysteresis	<i>HSH</i>	0.1 to 50.0 A (default: 0.1 A)	0.1 to 50.0	
HS Alarm 1 or 2 (alarm current)	<i>HS1</i> <i>HS2</i>	0.0 to 50.0 A (default: 50.0 A)	0.0 to 50.0	Adjustment Level
Leakage Current 1 or 2 Monitor	<i>LER1</i> <i>LER2</i>	0.0 to 55.0 A	0.0 to 55.0	
Auxiliary Output 1 to 4 Assignment	<i>SUB1</i> to <i>SUB4</i>	HS: HS alarm or HA: Heater alarm	<i>HS</i> or <i>HA</i>	Advanced Function Setting Level

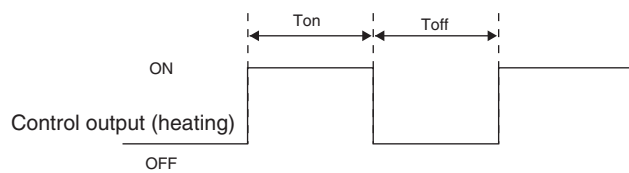

In the above diagram, power is considered to be OFF (normal) if the leakage current is less than *HS1* or *HS2* (heater short detection current) during the *Toff* interval. The HS alarm will be OFF in this case. If the leakage current is greater than *HS1* or *HS2* (heater short detection current) during the *Toff* interval, the HS alarm will turn ON. Heater shorts are not detected if the OFF time (*Toff*) for the control output for heating is 100 ms or less (35 ms or less if the control period is 0.1 or 0.2 s). Heater shorts are not detected in the following cases.

- Control will be continued even when there is an HS alarm.
- The rated current may sometimes differ slightly from the actual current flowing to the heater. Use the Leakage Current 1 Value Monitor and Leakage Current 2 Value Monitor parameters to check the leakage current during actual operation



Set the HS Alarm Use parameter to ON in the Advanced Function Setting Level and set the HS Alarm 1 parameter in the Adjustment Level. This procedure sets the HS Alarm 1 parameter to 2.5.

### Operating Procedure





- Setting the HS Alarm Use Parameter

<p><b>1</b> Press the  Key several times in the Advanced Function Setting Level to display <i>HSU</i> (HS Alarm Use).</p>	<p>Advanced Function Setting Level</p> <div style="border: 1px solid black; padding: 5px; display: inline-block;"> <i>HSU</i> <i>ON</i> </div> <p>HS Alarm Use</p>
<p><b>2</b> Check to see if the set value is <i>ON</i> (enabled, default).</p>	<div style="border: 1px solid black; padding: 5px; display: inline-block;"> <i>HSU</i> <i>ON</i> </div>

- Setting the Leakage Current Value Monitor

<p><b>1</b> Press the  Key several times in the Adjustment Level to display <b>LCR 1</b> (Leakage Current 1 Value Monitor).</p>	<p>Adjustment Level</p>  <p>Leakage Current 1 Value Monitor</p>
<p><b>2</b> Check the leakage current from the CT input that is used to detect heater short. The monitoring range is 0.0 to 55.0 A.</p>	

- Setting Heater Short Alarm Detection

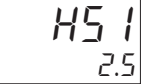
<p><b>1</b> Press the  Key several times in the Adjustment Level to display <b>HS 1</b> (HS Alarm 1).</p>	<p>Adjustment Level</p>  <p>HS Alarm 1</p>
<p><b>2</b> Press the  or  Key to set the set value to 2.5 Refer to 4-12-4 Calculating Detection Current Values when you set the value.</p>	

- If there is little difference between the current in normal and abnormal states, detection may be unstable. To stabilize detection, set a current difference of at least 1.0 A for heaters lower than 10.0 A, and at least 2.5 A for heaters of 10.0 A or higher. If the heater current is too low, loop the load line several times through a CT, as shown in the following diagram. Looping it through once will double the detected current.

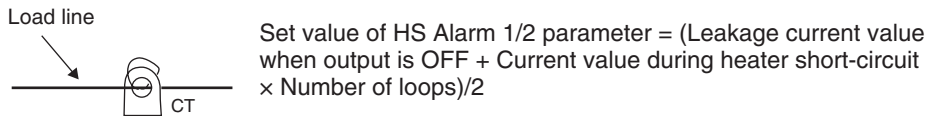

### 4-12-3 Installing Current Transformers (CT)

- CTs can be used for the heater burnout (HB) and heater short (HS) alarms. For the E5CC-T, connect the CT in advance to terminals 16 and 17 (CT1), or 17 and 18 (CT2). For the E5EC-T/E5AC-T, connect the CT in advance to terminals 19 and 20 (CT1) or 20 and 21 (CT2). Then pass the heater power line through the hole in the CT. For specifications, models, and dimensions of the CTs that can be used with the Digital Controller, refer to A-2 Current Transformer (CT).

#### (1) Single-phase Heaters

For single-phase heaters, install the CT in the position shown in the following diagram.

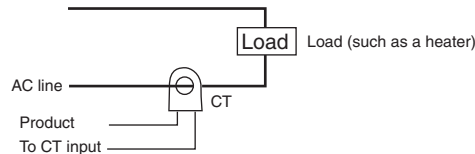

#### (2) Three-phase Heaters

When a 3-phase power supply is used, regardless of the types of connecting lines, two current transformers (CTs) are required to detect heater burnouts and heater shorts.

**(a) Delta connecting lines: Refer to the following diagram for CT installation positions.**

\* Heater voltage fluctuations are not considered, so be sure to take that into account when setting the detection current.

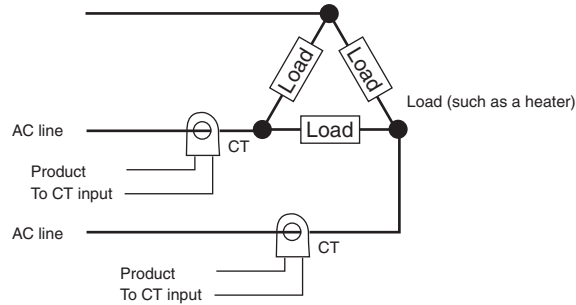

**(b) Star connecting lines: Refer to the following diagram for CT installation positions.**

\* Heater voltage fluctuations are not considered, so be sure to take that into account when setting the detection current.

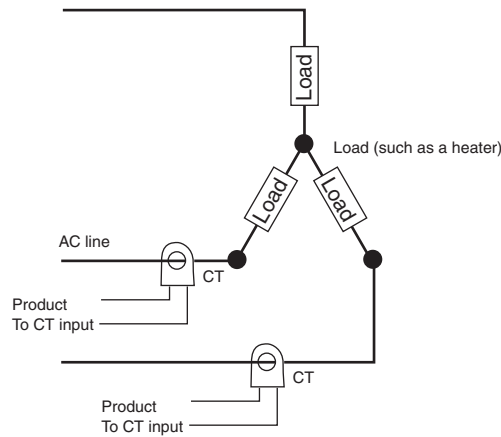

**(c) V connecting lines: Refer to the following diagram for CT installation positions.**

\* Heater voltage fluctuations are not considered, so be sure to take that into account when setting the detection current.

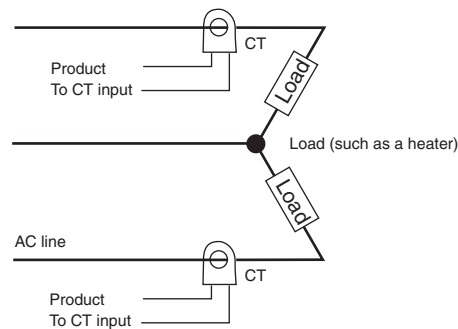

### 4-12-4 Calculating Detection Current Values

Calculate the set value using the following equation:

$$\text{Heater Burnout Detection 1/2 set value} = \frac{\text{Normal current value} + \text{Burnout current value}}{2}$$

$$\text{HS Alarm 1/2 set value} = \frac{\text{Leakage current value (output OFF)} + \text{HS current value}}{2}$$

- To set the current for heater burnout when two or more heaters are connected through the CT, use the value from when the heater with the smallest current burns out. If all of the heaters have the same current, use the value from when any one of them burns out.

Example: Set value of Heater Burnout Detection 1 or 2 parameter = (Normal current value × Number of loops + Burnout current value)/2

- Make sure that the following conditions are satisfied:
  - Heater with a current of less than 10.0 A:
    - (Normal current value) – (Burnout current value) ≥ 1 A
    - When the difference is less than 1 A, detection is unstable.
  - Heater with a current of 10.0 A or more:
    - (Normal current value) – (Burnout current value) ≥ 2.5 A
    - When the difference is less than 2.5 A, detection is unstable.
- The setting range is 0.1 to 49.9 A. Heater burnouts and heater shorts are not detected when the set value is 0.0 or 50.0. When the set value is 0.0, the HB alarm is always OFF and the HS alarm is always ON. When the set value is 50.0, the HB alarm is always ON and the HS alarm is always OFF.
- Set the total current value for normal heater operation to 50 A or less. When a current value of 55.0 A is exceeded, *FFFF* is displayed in the Heater Current 1 (or 2) Value Monitor and Leakage Current 1 (or 2) Monitor parameters.

### 4-12-5 Application Examples

#### (1) Single-phase Heaters

Example: Using a 200-VAC, 1-kW Heater

Normal

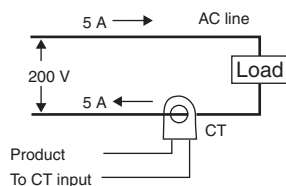

Burnout

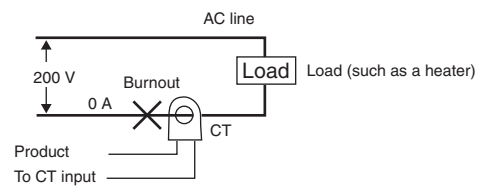

The heater power supply provides 5 A when the current is normal, and 0 A when there is a burnout, so the heater burnout detection current is calculated as follows:

$$\begin{aligned} \text{Heater burnout detection current} &= \frac{(\text{Normal current}) + (\text{Heater burnout current})}{2} \\ &= \frac{5 + 0}{2} = 2.5 \text{ [A]} \end{aligned}$$

Example: Using Three 200-VAC, 1-kW Heaters

Normal

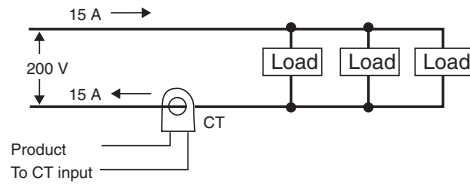

Burnout

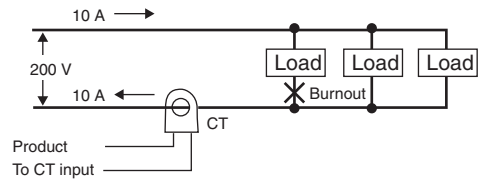

The heater power supply provides 15 A when the current is normal, and 10 A when there is a burnout, so the heater burnout detection current is calculated as follows:

$$\begin{aligned} \text{Heater burnout detection current} &= \frac{(\text{Normal current}) + (\text{Heater burnout current})}{2} \\ &= \frac{15 + 10}{2} = 12.5 \text{ [A]} \end{aligned}$$

(2) Three-phase Heaters

(a) Delta Connecting Lines

Example: Using Three 200-VAC, 2-kW Heaters

Normal

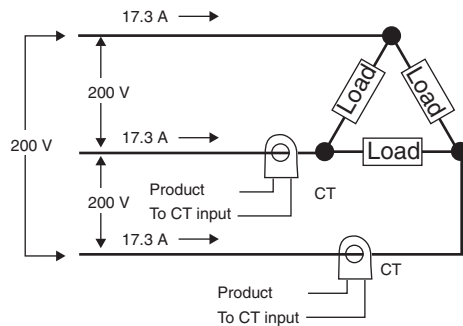

The current when each phase is normal is 17.3 A ( $\approx \sqrt{3} \times 10 \text{ A}$ ).

Normal

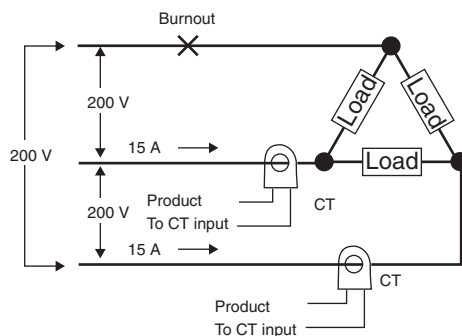

$$\begin{aligned} \text{Current when there is a burnout} &= 10 \text{ A} \times \sqrt{3} \times (\sqrt{3}/2) = 15 \text{ A} \end{aligned}$$

Burnout

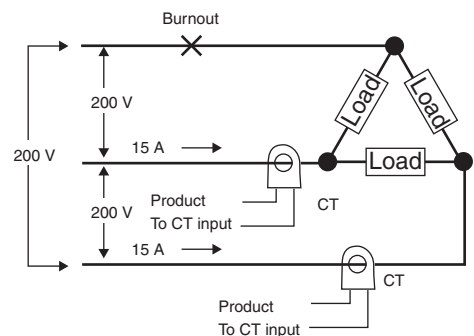

$$\begin{aligned} \text{Current when there is a burnout} &= 10 \text{ A} \times \sqrt{3} \times (1/\sqrt{3}) = 10 \text{ A} \end{aligned}$$

The heater burnout current when there is a burnout at the load line is as follows:

$$\text{(Heater burnout detection current)} = (17.3 + 15) / 2 = 16.15 \text{ [A]}$$

The heater burnout current when there is a burnout at the load is as follows:

$$(\text{Heater burnout detection current}) = (17.3 + 10) / 2 = 13.65 \text{ [A]}$$

To enable detection in either case, use 16.1 A as the heater burnout detection current.

**(b) Star Connecting Lines**

Example: Using Three 200-VAC, 2-kW Heaters

Normal

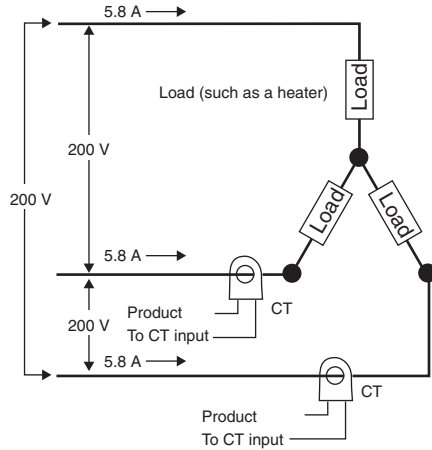

The current when each phase is normal is 5.8 A ( $\approx 10 \text{ A} \times (1/\sqrt{3})$ ).

Normal

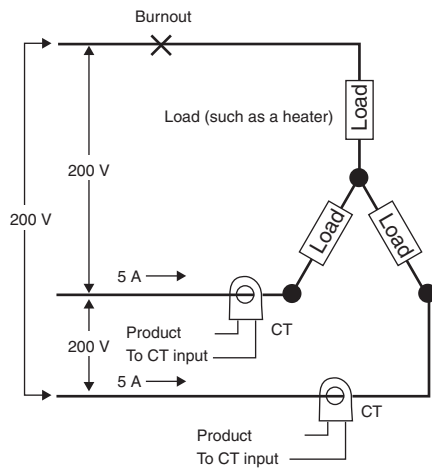

Current when there is a burnout =  $10 \text{ A} \times (1/\sqrt{3}) \times (\sqrt{3}/2) = 5 \text{ A}$

Burnout

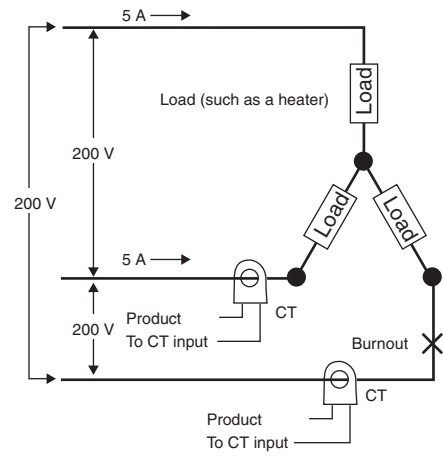

Current when there is a burnout =  $10 \text{ A} \times (1/\sqrt{3}) \times (\sqrt{3}/2) = 5 \text{ A}$

The heater burnout detection current for this connecting line is 5.4 A ( $= (5.8 + 5) / 2$ ).



**(c) V Connecting Lines**

Example: Using Two 200-VAC, 2-kW Heaters

Normal

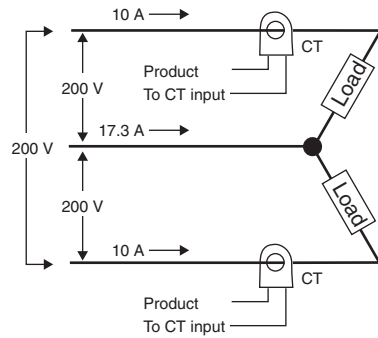

Normal

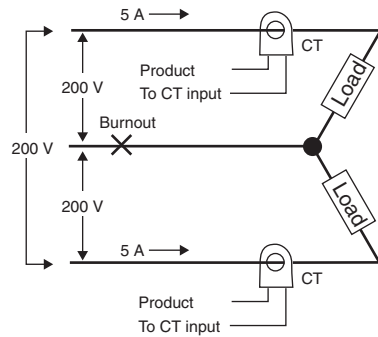

Current when there is a burnout =  $10\text{ A} \times (1/2) = 5\text{ A}$

Burnout

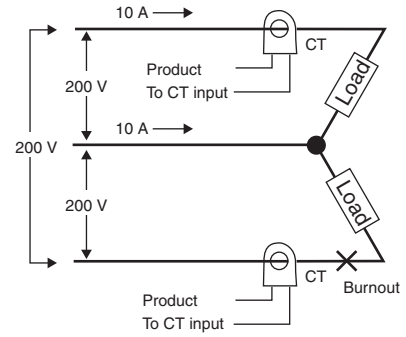

Current when there is a burnout = 0 A

The heater burnout current when there is a burnout at the common is as follows:

Heater burnout detection current =  $(10 + 5) / 2 = 7.5\text{ [A]}$

The heater burnout current when there is a burnout at the load is as follows:

Heater burnout detection current =  $(10 + 0) / 2 = 5\text{ [A]}$

To enable detection in either case, use 7.5 A as the heater burnout detection current.

## 4-13 Using ON/OFF Control (Not Supported for Position-proportional Models.)

In ON/OFF control, the control output turns OFF when the temperature being controlled reaches the preset set point. When the manipulated variable turns OFF, the temperature begins to fall and the control turns ON again. This operation is repeated over a certain temperature range. At this time, how much the temperature must fall before control turns ON again is determined by the Hysteresis (Heating) parameter. Also, what direction the manipulated variable must be adjusted in response to an increase or decrease in the process value is determined by the Direct/Reverse Operation parameter.

### 4-13-1 ON/OFF Control

- Switching between 2-PID control and ON/OFF control is performed using the PID ON/OFF parameter in the Initial Setting Level. When this parameter is set to  $P_{\bar{L}d}$ , 2-PID control is selected, and when it is set to  $\bar{a}N\bar{a}F$ , ON/OFF control is selected. The default is  $P_{\bar{L}d}$ .

#### ● Hysteresis

- With ON/OFF control, hysteresis is used to stabilize operation when switching between ON and OFF. The control output (heating) and control output (cooling) functions are set in the Hysteresis (Heating) and Hysteresis (Cooling) parameters, respectively.
- In standard control (heating or cooling control), the setting of the Hysteresis (Heating) parameter in the Adjustment Level is used as the hysteresis regardless of whether the control type is heating control or cooling control.

Reverse operation

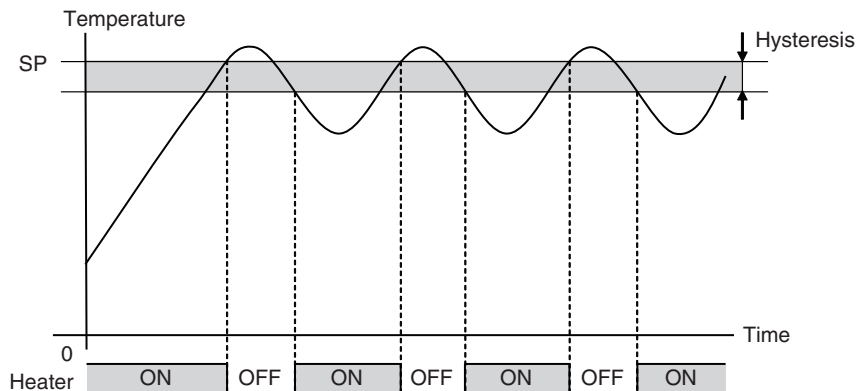

## Parameters

Display	Parameter	Application	Level
S-HE	Standard or Heating/Cooling	Specifying control method	Initial Setting Level
ENEL	PID ON/OFF	Specifying control method	Initial Setting Level
OREV	Direct/Reverse Operation	Specifying control method	Initial Setting Level
E-db	Dead Band	Heating/cooling control	Adjustment Level
HYS	Hysteresis (Heating)	ON/OFF control	Adjustment Level
CHYS	Hysteresis (Cooling)	ON/OFF control	Adjustment Level



### 4-13-2 Settings

To execute ON/OFF control, set the Set Point, PID ON/OFF, and Hysteresis parameters.

#### Setting the PID ON/OFF Parameter

Confirm that the PID ON/OFF parameter is set to  $\bar{a}N\bar{o}F$  in the Initial Setting Level.

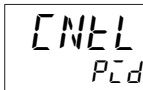
##### Operating Procedure

<p><b>1</b> Press the <math>\text{☐}</math> Key several times in the Initial Setting Level to display <math>ENEL</math> (PID ON/OFF). The default is <math>P\bar{L}d</math> (PID control).</p>	<p>Initial Setting Level</p>  <p>PID ON/OFF</p>
<p><b>2</b> Press the <math>\text{▲}</math> Key to display <math>\bar{a}N\bar{o}F</math> (ON/OFF control).</p>	

#### Setting the SP

For the E5□C-T, there are two ways to set the SP: use a program SP or a set a fixed SP. Refer to the following sections for details.

- Program SP  
Refer to 4-7 Setting Programs.
- Fixed SP  
Refer to 4-8 Setting the Fixed SP

#### Setting the Hysteresis

Set the hysteresis to 2.0°C.

##### Operating Procedure

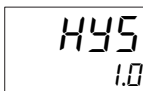
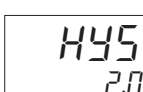
<p><b>1</b> Press the <math>\text{☐}</math> Key several times in the Adjustment Level to display <math>HYS</math> (Hysteresis (Heating)).</p>	<p>Adjustment Level</p>  <p>Hysteresis (Heating)</p>
<p><b>2</b> Press the <math>\text{▲}</math> or <math>\text{▼}</math> Key to set the hysteresis to 2.0. The default is 1.0.</p>	

## 4-14 Customizing the PV/SP Display

The following table shows the contents of the No. 1, 2, and 3 displays, according to the setting of the PV/SP Display Screen Selection parameter.

### 4-14-1 PV/SP Display Selections

The following table shows the contents of the No. 1, 2, and 3 displays, according to the setting of the PV/SP Display Screen Selection parameter in the Advanced Function Setting Level.

Set value	No. 1 display	No. 2 display	No. 3 display (E5EC-T/E5AC-T only)
0	Nothing is displayed.	Nothing is displayed.	Nothing is displayed.
1	PV	SP	Nothing is displayed.
2	PV	Nothing is displayed.	Nothing is displayed.
3	SP	SP (character display)	Nothing is displayed.
4	PV	SP	MV (heating) (Valve opening for Position-proportional Models)
5	PV	SP	MV (cooling)
6	PV	SP	Program number and segment number
7	PV	SP	Remaining segment time

	Monitoring range	Unit
PV	Temperature input: The specified range for the specified sensor. Analog input: Scaling lower limit $-5\%FS$ to Scaling upper limit $+5\%FS$	EU

	Setting (monitoring) range	Unit
SP	SP lower limit to SP upper limit	EU

During temperature input, the decimal point position depends on the currently selected sensor, and during analog input it depends on the Decimal Point parameter setting.

#### PV/SP Display Selections

Code	Parameter	Default	Level
<i>SPd1</i>	PV/SP No. 1 Display Selection	6	Advanced Function Setting Level
<i>SPd2</i>	PV/SP No. 2 Display Selection	E5CC-T: 0 E5EC-T/E5AC-T: 7	

# 5

## Advanced Operations

<b>5-1</b>	<b>Shifting Input Values</b>	<b>5-3</b>
<b>5-2</b>	<b>Setting Scaling Upper and Lower Limits for Analog Inputs</b>	<b>5-5</b>
<b>5-3</b>	<b>Executing Heating/Cooling Control (Not Supported for Position-proportional Models.)</b>	<b>5-7</b>
5-3-1	Heating/Cooling Control	5-7
<b>5-4</b>	<b>Using Event Inputs</b>	<b>5-11</b>
5-4-1	Event Input Settings	5-11
5-4-2	Using Event Inputs	5-11
<b>5-5</b>	<b>Setting the SP Upper and Lower Limit Values</b>	<b>5-16</b>
5-5-1	Set Point Limiter	5-16
5-5-2	Setting	5-17
<b>5-6</b>	<b>Using the Key Protect Level</b>	<b>5-18</b>
5-6-1	Protection	5-18
5-6-2	Entering the Password to Move to the Protect Level	5-19
<b>5-7</b>	<b>Hiding Parameters</b>	<b>5-21</b>
5-7-1	Parameter Mask Settings	5-21
<b>5-8</b>	<b>OR Output of Alarms</b>	<b>5-23</b>
5-8-1	Integrated Alarm	5-23
<b>5-9</b>	<b>Alarm Delays</b>	<b>5-25</b>
5-9-1	Alarm Delays	5-25
<b>5-10</b>	<b>Loop Burnout Alarm (Not Supported for Position-proportional Models.)</b>	<b>5-27</b>
5-10-1	Loop Burnout Alarm (LBA)	5-27
<b>5-11</b>	<b>Performing Manual Control</b>	<b>5-31</b>
5-11-1	Manual MV	5-31
<b>5-12</b>	<b>Using the Transfer Output</b>	<b>5-34</b>
5-12-1	Transfer Output Function	5-34
<b>5-13</b>	<b>Using PID Sets</b>	<b>5-37</b>
5-13-1	PID Sets	5-37
5-13-2	Settings for PID Sets	5-41
5-13-3	Setting PID Set Parameters	5-44

<b>5-14 Determining PID Constants for PID Sets (Autotuning for All PID Sets) ..</b>	<b>5-45</b>
5-14-1 Autotuning All PID Sets (Autotuning) .....	5-45
5-14-2 Executing Autotuning for All PID Sets .....	5-48
<b>5-15 Program-related Functions .....</b>	<b>5-53</b>
5-15-1 Advance .....	5-53
5-15-2 Segment Jump .....	5-54
5-15-3 Hold .....	5-54
5-15-4 Wait .....	5-55
5-15-5 Program Repetition .....	5-56
5-15-6 Program Links .....	5-56
5-15-7 SP Shift .....	5-57
5-15-8 Time Signals .....	5-57
5-15-9 Program end outputs .....	5-59
5-15-10 RUN Output .....	5-60
5-15-11 Stage Outputs .....	5-61
5-15-12 PV Start .....	5-61
5-15-13 Standby Operation .....	5-63
5-15-14 Changing the SP Mode .....	5-64
5-15-15 SP Tracking .....	5-65
5-15-16 Operations Related to Other Functions .....	5-66
<b>5-16 Output Adjustment Functions .....</b>	<b>5-67</b>
5-16-1 Output Limits .....	5-67
5-16-2 MV at Reset .....	5-67
5-16-3 MV at PV Error .....	5-68
<b>5-17 Using the Extraction of Square Root Parameter .....</b>	<b>5-70</b>
5-17-1 Extraction of Square Roots .....	5-70
<b>5-18 Setting the Width of MV Variation .....</b>	<b>5-72</b>
5-18-1 MV Change Rate Limit .....	5-72
<b>5-19 Setting the PF Key .....</b>	<b>5-74</b>
5-19-1 PF Setting (Function Key) .....	5-74
<b>5-20 Displaying PV/SV Status .....</b>	<b>5-77</b>
5-20-1 PV and SV Status Display Functions .....	5-77
<b>5-21 Controlling Valves (Can Be Used with a Position-proportional Model) ..</b>	<b>5-79</b>
<b>5-22 Logic Operations .....</b>	<b>5-82</b>
5-22-1 The Logic Operation Function (CX-Thermo) .....	5-82
5-22-2 Using Logic Operations .....	5-82
<b>5-23 Using the CX-Thermo to Set Programs .....</b>	<b>5-91</b>
5-23-1 Introduction .....	5-91
5-23-2 Using the Program Setting Functions .....	5-92
5-23-3 Names and Functions of Objects in the Programmer Editor .....	5-93
5-23-4 Program Setting Procedures .....	5-97

# 5-1 Shifting Input Values

## ● Shifting Inputs

You can set the PV Slope Coefficient and PV Input Shift parameters to compensate the PV.

Parameter	Setting range	Unit	Default
PV Input Shift	Temperature input: -199.9 to 999.9	°C or °F	0.0
	Analog input: -1,999 to 9,999	EU	0
PV Slope Coefficient	0.001 to 9.999	None	1.000

- Calculating the PV Slope Coefficient and PV Input Shift

In the following equation,  $PV_i$  is the input to the calculation,  $PV_o$  is the result,  $INRT$  is the PV slope coefficient, and  $INS$  is the PV input shift:  $PV_o = (PV_i \times INRT) + INS$

## ● Moving Average

- The moving average operation reduces sudden changes in the input due to noise and other factors, and can be enabled separately for each input.
- The Moving Average Count parameter is used for the moving average. It can be set to OFF, 2, 4, 8, 16, or 32.
- The default is OFF (disabled).

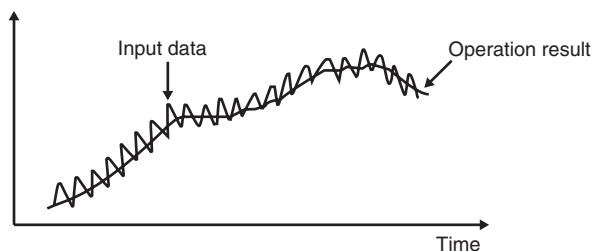

Parameter	Setting range	Unit	Default
Moving Average Count	OFF, 2, 4, 8, 16, or 32	Times	OFF

### ● Using the PV Input Shift

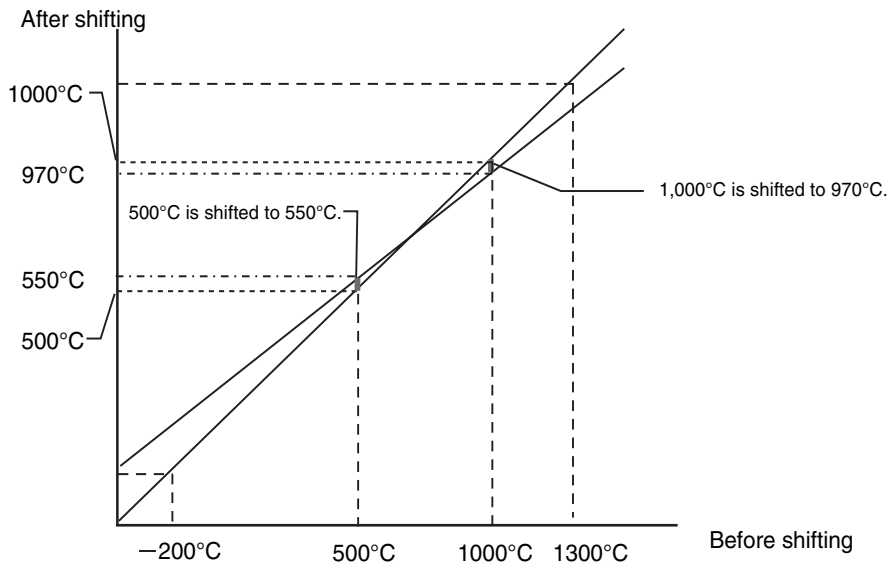

- (1) **Find the two points to shift and determine the PVs after the shifts are applied.**  
 Example: Shift 500°C (temperature before shifting) to 550°C (temperature after shifting).  
 Example: Shift 1,000°C (temperature before shifting) to 970°C (temperature after shifting).
- (2) **Find the PV slope coefficient from the above results.**  

$$(970 - 550) / (1,000 - 500) = 0.840$$
 \* Do not yet set the PV Slope Coefficient parameter in the Digital Controller.
- (3) **Adjust the PV display on the Digital Controller to the point to be shifted.**  
 Example: Adjust the PV to 500°C.
- (4) **Set the PV Slope Coefficient parameter to the value that you found in step 2.**  
 Example: Set the PV Slope Coefficient parameter to 0.840.
- (5) **Read off the PV after the setting is changed.**  
 Example: The PV will be displayed as 420°C.
- (6) **Find the difference between the anticipated PV (i.e., the PV after shifting) and the PV that you read off in step 5.**  
 Example:  $550^{\circ}\text{C} - 420^{\circ}\text{C} = 130^{\circ}\text{C}$
- (7) **Set the PV Input Shift parameter to the value that you found in step 6.**  
 Example: Set the PV Input Shift parameter to 130°C.



## 5-2 Setting Scaling Upper and Lower Limits for Analog Inputs

### ● Analog Input

$\bar{N}-H$  Scaling Upper Limit

$\bar{N}-L$  Scaling Lower Limit

$dP$  Decimal Point

- When an analog input is selected, scaling can be performed as needed by the control application.
- Scaling is set in the Scaling Upper Limit, Scaling Lower Limit, and Decimal Point parameters (Initial Setting Level). These parameters cannot be used when a temperature input is selected.
- The Scaling Upper Limit parameter sets the physical quantity to be expressed by the upper limit value of input, and the Scaling Lower Limit parameter sets the physical quantity to be expressed by the lower-limit value of input. The Decimal Point parameter specifies the number of digits below the decimal point.
- The following figure shows a scaling example for a 4 to 20 mA input. After scaling, the temperature can be directly read. Here, one place below the decimal point is set.

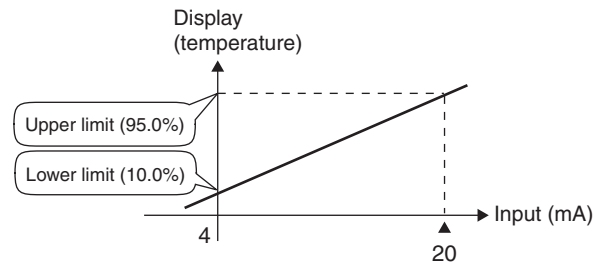

In this example scaling is set to display 4 to 20 mA as 10.0% to 95.0%.

#### Operating Procedure



- Setting the Input Type

<p><b>1</b> Move to the Initial Setting Level. <math>\bar{N}-L</math> (Input Type) will be displayed.</p>	<p>Initial Setting Level</p> <p><math>\bar{N}-L</math> Input Type 5</p>
<p><b>2</b> Press the <math>\uparrow</math> or <math>\downarrow</math> Key to set the value to 25. The default is 5.</p>	<p><math>\bar{N}-L</math> 25</p>



- Setting the Scaling Upper Limit

<p><b>1</b> Press the <math>\text{Ⓢ}</math> Key several times in the Initial Setting Level to display <math>\bar{N}-H</math> (Scaling Upper Limit).</p>	<p>Initial Setting Level</p> <p><math>\bar{N}-H</math> Scaling Upper Limit 100</p>
<p><b>2</b> Press the <math>\uparrow</math> or <math>\downarrow</math> Key to set the value to 950. The default is 100.</p>	<p><math>\bar{N}-H</math> 950</p>

- Setting the Scaling Lower Limit

<p><b>1</b> Press the  Key several times in the Initial Setting Level to display <math>\bar{L}N-L</math> (Scaling Lower Limit).</p>	<p>Initial Setting Level</p> <div style="border: 1px solid black; padding: 5px; display: inline-block;"> <math>\bar{L}N-L</math>  <span style="font-size: small;">0</span> </div> <p>Scaling Lower Limit</p>
<p><b>2</b> Press the  or  Key to set the value to 100. The default is 0.</p>	<div style="border: 1px solid black; padding: 5px; display: inline-block;"> <math>\bar{L}N-L</math>  <span style="font-size: small;">100</span> </div>

- Setting the Decimal Point

<p><b>1</b> Press the  Key several times in the Initial Setting Level to display <math>dP</math> (Decimal Point).</p>	<p>Initial Setting Level</p> <div style="border: 1px solid black; padding: 5px; display: inline-block;"> <math>dP</math>  <span style="font-size: small;">0</span> </div> <p>Decimal Point</p>
<p><b>2</b> Press the  or  Key to set the value to 1. The default is 0.</p>	<div style="border: 1px solid black; padding: 5px; display: inline-block;"> <math>dP</math>  <span style="font-size: small;">1</span> </div>

## 5-3 Executing Heating/Cooling Control (Not Supported for Position-proportional Models.)

### 5-3-1 Heating/Cooling Control

Heating/cooling control can be used with control output 2 and auxiliary outputs 1 to 4. Heating/cooling control operates when  $H-C$  (heating/cooling) is selected for the Standard or Heating/Cooling parameter. The following functions are assigned to outputs in the default status.

Parameter name	Display	Initial status
Control Output 1 Assignment	$\bar{a}U\bar{t}1$	Control output for heating
Control Output 2 Assignment	$\bar{a}U\bar{t}2$	Not assigned.
Auxiliary Output 1 Assignment	$SUb1$	Alarm 1*
Auxiliary Output 2 Assignment	$SUb2$	Alarm 2
Auxiliary Output 3 Assignment	$SUb3$	Alarm 3
Auxiliary Output 4 Assignment (E5EC-T/E5AC-T only)	$SUb4$	Alarm 4

\* If the Controller is equipped with HB/HS alarm detection, it is set by default to  $HR$  (Heater Alarm).

Each output assignment is automatically initialized as shown below when changing between standard and heating/cooling control.

#### Assigned Output Functions

E5CC-T

Parameter name	Display	Without control output 2		With control output 2	
		Standard	Heating/cooling	Standard	Heating/cooling
Control Output 1 Assignment	$\bar{a}U\bar{t}1$	Control output (heating)	Control output (heating)	Control output (heating)	Control output (heating)
Control Output 2 Assignment	$\bar{a}U\bar{t}2$	---	---	Not assigned.	Control output (cooling)
Auxiliary Output 1 Assignment	$SUb1$	Alarm 1*	Alarm 1*	Alarm 1*	Alarm 1*
Auxiliary Output 2 Assignment	$SUb2$	Alarm 2	Control output (cooling)	Alarm 2	Alarm 2
Auxiliary Output 3 Assignment	$SUb3$	Alarm 3	Alarm 3	Alarm 3	Alarm 3

E5EC-T/E5AC-T

Parameter name	Display	Without control output 2		With control output 2	
		Standard	Heating/cooling	Standard	Heating/cooling
Control Output 1 Assignment	$\bar{a}U\bar{t}1$	Control output (heating)	Control output (heating)	Control output (heating)	Control output (heating)
Control Output 2 Assignment	$\bar{a}U\bar{t}2$	---	---	Not assigned.	Control output (cooling)
Auxiliary Output 1 Assignment	$SUb1$	Alarm 1*	Alarm 1*	Alarm 1*	Alarm 1*

Parameter name	Display	Without control output 2		With control output 2	
		Standard	Heating/cooling	Standard	Heating/cooling
Auxiliary Output 2 Assignment	5U62	Alarm 2	Alarm 2	Alarm 2	Alarm 2
Auxiliary Output 3 Assignment	5U63	Alarm 3	Alarm 3	Alarm 3	Alarm 3
Auxiliary Output 4 Assignment	5U64	Alarm 4	Control output (cooling)	Alarm 4	Alarm 4

\* If the Controller is equipped with HB/HS alarm detection, it is set by default to *HR* (Heater Alarm).

- The heating/cooling operation of the control outputs will switch when the Direct/Reverse Operation parameter is set to direct operation.
- When DRS (Invert Direct/Reverse Operation) is set for an Event Input Assignment 1 to 6 parameter, control will start with the opposite of the setting of the Direct/Reverse Operation parameter when the event input turns ON. When the event input turns OFF, control will return to operation according to the setting of the Direct/Reverse Operation parameter. For details on event inputs and control combined with the Direct/Reverse Operation parameter, refer to *Control by Inverting Direct/Reverse Operation* on page 5-13.
- If heating/cooling control is selected, also set the Dead Band, Proportional Band (Cooling), Integral Time (Cooling), Derivative Time (Cooling), and Heating/Cooling Tuning Method parameters.

● **Dead Band**

- For heating/cooling control, the dead band is set with the set point as its center. The dead band width is the set value of the Dead Band parameter (Adjustment Level). Setting a negative value produces an overlapping band.
- If an overlapping band is set, the bumpless function may not operate when switching between manual operation and automatic operation.
- The default is 0.0 EU for Controllers with Temperature Inputs and 0.00% FS for Controllers with Analog Inputs.

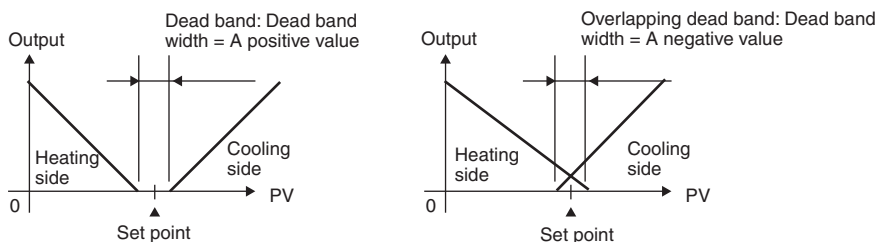

## ● Heating/Cooling PID Control

If heating/cooling PID control is used, you can set PID control separately for heating and cooling. The PID constants for both heating and cooling can be automatically set according to the cooling control characteristics by setting the Heating/Cooling Tuning Method parameter and then performing autotuning (AT).

Parameter	Setting range	Default	Level
Heating/Cooling Tuning Method	0: Same as heating control	0	Advanced Function Setting Level
	1: Linear		
	2: Air cooling		
	3: Water cooling		

Parameter	Setting range	Unit	Default	Level	
Proportional Band (Cooling)	Temperature input	0.1 to 999.9	°C or °F	8.0	Adjustment Level
	Analog input		%FS	10.0	
Integral Time (Cooling)*	Integral/Derivative Time Unit of 1 s	0 to 9999	Seconds	233	
	Integral/Derivative Time Unit of 0.1 s		Seconds	233.0	
Derivative Time (Cooling)*	Integral/Derivative Time Unit of 1 s	0 to 9999	Seconds	40	
	Integral/Derivative Time Unit of 0.1 s		Seconds	40.0	

\* The unit is determined by the setting of the Integral/Derivative Time Unit parameter. The Proportional Band (Cooling), Integral Time (Cooling), and Derivative Time (Cooling) parameters are initialized if the Integral/Derivative Time Unit parameter is changed.

### Air Cooling/Water Cooling Tuning

Control that is suitable for an application that does not have linear cooling characteristics (such as plastic molding machines) is performed. The response is fast and the response characteristics are stable.

### Linear Tuning

Control that is suitable for an application that has linear cooling characteristics is performed.

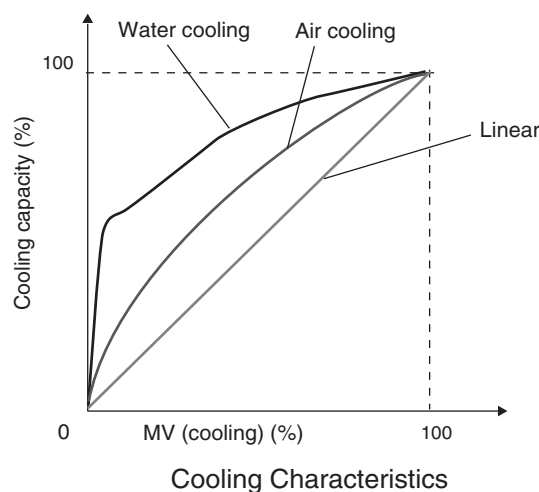

● **Three-position Control**

- Set the PID ON/OFF parameter to  $\bar{0}N\bar{0}F$  and set the Standard or Heating/Cooling Parameter to  $H-L$  to perform three-position control.
- A dead band (an area where the MV is 0) can be set for either heating or cooling control.

Reverse operation

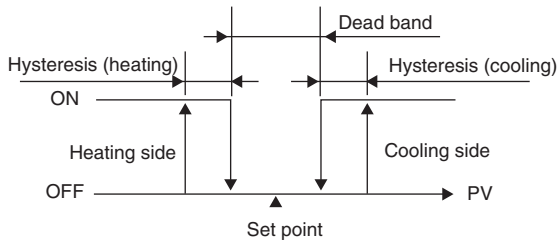

## 5-4 Using Event Inputs

### 5-4-1 Event Input Settings

- The number of event inputs that is supported depends on the model of the Digital Controller.  
E5CC-T: Up to 4 event inputs  
E5EC-T/E5AC-T: Up to 6 event inputs
- Event inputs can be used for changing between run and reset status, changing between automatic and manual operation, holding, advancing, inverting direct/reverse operation, changing the SP mode, executing/canceling 100% AT, executing/canceling 40% AT, executing/canceling 100% AT for all PID sets, executing/canceling 40% AT for all PID sets, enabling/disabling setting changes, enabling/disabling communications write, canceling the alarm latch, enabling/disabling wait operation, and changing the program number.

### 5-4-2 Using Event Inputs

The following table shows the functions that can be assigned when an Event Input Assignment 1 or 6 parameter is displayed.

Setting	Function
<i>NONE</i>	None
<i>RR-1</i>	Run (OFF)/Reset (ON)
<i>RR-2</i>	Run (ON)/Reset (OFF)
<i>MANU</i>	Auto/Manual
<i>RSE</i>	Reset
<i>RUN</i>	Run
<i>HLd1</i>	Hold/Clear Hold
<i>HLd2</i>	Hold
<i>ADV</i>	Advance <sup>*1</sup>
<i>PRG0</i>	Program Number Switch 0 <sup>*2</sup>
<i>PRG1</i>	Program Number Switch 1 <sup>*2</sup>
<i>PRG2</i>	Program Number Switch 2 <sup>*2</sup>
<i>dRS</i>	Invert Direct/Reverse Operation
<i>SPM</i>	Program SP Mode/Fixed SP Mode <sup>*3</sup>
<i>RE-2</i>	100% AT Execute/Cancel
<i>RE-1</i>	40% AT Execute/Cancel <sup>*4</sup>
<i>REAR2</i>	All PID 100% AT Execute/Cancel
<i>REAR1</i>	All PID 40% AT Execute/Cancel <sup>*4</sup>
<i>WELP</i>	Setting Change Enable/Disable
<i>CMWE</i>	Communications Writing Enable/Disable <sup>*5</sup>
<i>LAL</i>	Alarm Latch Cancel
<i>WARL</i>	Wait Enable/Disable

\*1 The event input must be turned OFF first before this function can be activated again. This function is enabled only during program operation.

\*2 These functions are enabled only in reset status.

\*3 This function is enabled only when the Reset Operation parameter is set to stop control.

\*4 This function can be set for heating/cooling control or for floating control for Position-proportional Models, but the setting will be disabled.

\*5 This function can be set only for a Controller that supports communications. Also, when a work bit is selected as the event input data, Communications Write Enable/Disable cannot be assigned.

Turn event inputs ON and OFF while the power is being supplied. Event input ON/OFF changes are detected for inputs of 50 ms or longer.

The functions are described in detail below.

### ● Changing the Run/Reset Status

When the Event Input Assignment parameter is set to RR-1 (Run (OFF)/Reset (ON)), program operation will start when the event input turns OFF. Program operation is stopped when the event input turns ON.

Alarm outputs, however, will be according to the process value.

The RST (reset) indicator will be lit while the Controller is in reset status.

Input contact	Status
ON	RST
OFF	RUN

### ● Switching between Auto and Manual Control

When the Event Input Assignment parameter is set to MANU (auto/manual), manual control will start when event input turns ON. Auto control will start when the input turns OFF.

The MANU indicator will light during manual control.

Input contact	Status
OFF	Automatic
ON	Manual

### ● Holding and Clearing a Hold

When the Event Input Assignment parameter is set to HLD1 (Hold/Hold Clear), program operation is held while the event input is ON. Hold status will be cleared when the event input turns OFF. This function is enabled only during program operation.

Input contact	Status
OFF	Hold cleared.
ON	Hold

### ● Holding a Program

When the Event Input Assignment parameter is set to HLD2 (Hold), program operation is held while the event input is ON. This function is enabled only during program operation.

Input contact	Status
OFF	No change.
ON	Hold

### ● Advancing a Program

When the Event Input Assignment parameter is set to ADV (advance), the program will move to the next segment when the event input turns ON. The event input must be turned OFF first before this function can be activated again. This function is enabled only during program operation.

Input contact	Status
OFF	No change.
ON	Advance

### ● Changing the Program

When the Event Input Assignment parameter is set to PRG\*, the ON/OFF status of the event inputs can be used to specify the number of the program to change to. The relation between the ON/OFF



status of the event inputs and the number of the selected program is shown in the following table. The status of any input that is not assigned is taken as OFF.

	Program number							
	0	1	2	3	4	5	6	7
Program Number Switch 0	OFF	ON	OFF	ON	OFF	ON	OFF	ON
Program Number Switch 1	OFF	OFF	ON	ON	OFF	OFF	ON	ON
Program Number Switch 2	OFF	OFF	OFF	OFF	ON	ON	ON	ON

### ● Control by Inverting Direct/Reverse Operation

When the Event Input Assignment parameter is set to DRS (Invert Direct/Reverse Operation) and the Direct/Reverse Operation parameter is set for reverse operation, control starts with direct operation (cooling control) when the event input turns ON and control starts with reverse operation (heating control) when the event input turns OFF.

Input contact	Direct/Reverse Operation parameter	Status
OFF	Direct operation (cooling)	Direct operation (cooling)
	Reverse operation (heating)	Reverse operation (heating)
ON	Direct operation (cooling)	Reverse operation (heating)
	Reverse operation (heating)	Direct operation (cooling)

### ● Switching the SP Mode

When the Event Input Assignment parameter is set to SPM (Program SP Mode/Fixed SP Mode), Program SP Mode is used while the event input is OFF. Fixed SP Mode is used when the event input is ON.

Input contact	Status
OFF	Program SP Mode
ON	Fixed SP Mode

### ● Switching 100% AT Execute/Cancel

When the Event Input Assignment parameter is set to AT-2 (100% AT Execute/Cancel), 100% AT will be executed when the event input turns ON and will be cancelled when the input turns OFF.

Input contact	Status
OFF	AT cancelled
ON	100% AT executed

### ● Switching 40% AT Execute/Cancel

When the Event Input Assignment parameter is set to AT-1 (40% AT Execute/Cancel), 40% AT will be executed when the event input turns ON and will be cancelled when the input turns OFF.

Input contact	Status
OFF	AT cancelled
ON	40% AT executed

### ● Switching between 100% AT Execute/Cancel for All PID Sets

When the Event Input Assignment parameter is set to ATA2 (All PID 100% AT Execute/Cancel), 100% AT will be executed for all PID sets when the event input turns ON. AT will be cancelled when the input turns OFF. This function is enabled only during Fixed SP Mode.

Input contact	Status
OFF	AT canceled.
ON	100% AT executed for all PID sets.

### ● Switching between 40% AT Execute/Cancel for All PID Sets

When the Event Input Assignment parameter is set to ATA1 (All PID 40% AT Execute/Cancel), 40% AT will be executed for all PID sets when the event input turns ON. AT will be cancelled when the input turns OFF. This function is enabled only during Fixed SP Mode.

Input contact	Status
OFF	AT canceled.
ON	40% AT executed for all PID sets.

### ● Switching Setting Change Enable/Disable

When the Event Input Assignment parameter is set to WTPT (Setting Change Enable/Disable), the setting change will be disabled when the event input turns ON and will be enabled when the input turns OFF.

Input contact	Status
OFF	Enabled
ON	Disabled

### ● Switching Communications Write Enable/Disable

When the Event Input Assignment parameter is set to CMWT (Setting Change Enable/Disable), writing with communications will be enabled when the event input turns ON and writing with communications will be disabled when the event input turns OFF.

Input contact	Status
OFF	Disabled
ON	Enabled

### ● Switching Alarm Latch Cancel

When the Event Input Assignment parameter is set to LAT (Alarm Latch Cancel), all alarm latches (alarms 1 to 4, heater burnout alarm, HS alarm, latch) will be cancelled when event input turns ON.

Input contact	Status
OFF	---
ON	Cancelled

### ● Enabling and Disabling Wait Operation

When the Event Input Assignment parameter is set to WAIT (Wait Enable/Disable), wait operation is enabled while the event input is ON. When the event input turns OFF, wait operation will be disabled. This function is enabled only during program operation.

Input contact	Status
OFF	Wait operation disabled.
ON	Wait operation enabled.

## Parameters

Display	Parameter	Description	Level
<i>EV-1</i>	Event Input Assignment 1	Function of event input	Initial Setting Level
<i>EV-2</i>	Event Input Assignment 2		Initial Setting Level
<i>EV-3</i>	Event Input Assignment 3		Initial Setting Level
<i>EV-4</i>	Event Input Assignment 4		Initial Setting Level
<i>EV-5</i>	Event Input Assignment 5		Initial Setting Level
<i>EV-6</i>	Event Input Assignment 6		Initial Setting Level

## 5-5 Setting the SP Upper and Lower Limit Values

### 5-5-1 Set Point Limiter

The setting range of the set point is limited by the set point limiter. This function can be used to prevent setting incorrect set points. The upper- and lower-limit values of the set point limiter are set using the Set Point Upper Limit and Set Point Lower Limit parameters in the Initial Setting Level. If the set point is not within the range set for the set point limiter as the result of changes to the Set Point Upper Limit or Set Point Lower Limit parameter, the set point will automatically be changed to a value within the set range. Also, when the input type and the temperature unit, scaling upper-limit value, or lower-limit value are changed, the set point limiter is forcibly reset to the input setting range or the scaling upper- or lower-limit value.

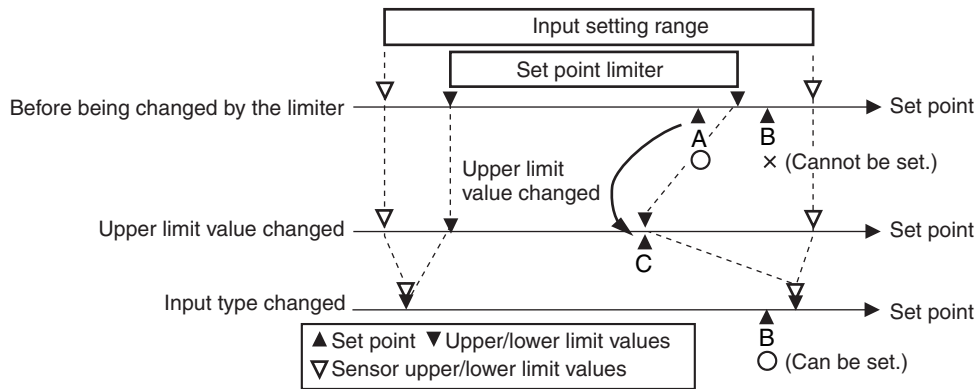

### Parameters

Parameters	Parameter	Description	Level
SL-H	Set Point Upper Limit	To limit the SP setting	Initial Setting Level
SL-L	Set Point Lower Limit	To limit the SP setting	Initial Setting Level

### 5-5-2 Setting

Set the set point upper and lower limits in the Set Point Upper Limit and Set Point Lower Limit parameters in the Initial Setting Level. In this example, it is assumed that the input type is set to a K thermocouple with a temperature range of -200 to 1300°C.

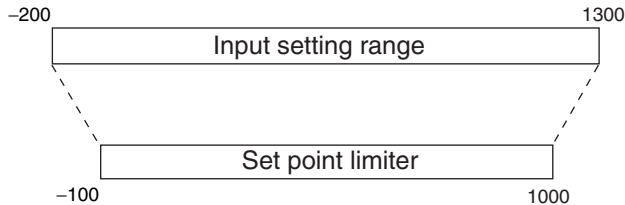

Set the upper and lower limits for the set point.  
 Set Point Upper Limit = 1000  
 Set Point Lower Limit = -100

#### Operating Procedure

- Setting the Set Point Upper Limit



<p><b>1</b> Press the  Key several times in the Initial Setting Level to display <b>SL -H</b> (Set Point Upper Limit).</p>	<p>Initial Setting Level</p> <div style="border: 1px solid black; padding: 5px; display: inline-block;"> <p><b>SL -H</b> 1300</p> </div> <p>Set Point Upper-limit</p>
<p><b>2</b> Press the  or  Key to set the value to 1000. The default is 1300.</p>	<div style="border: 1px solid black; padding: 5px; display: inline-block;"> <p><b>SL -H</b> 1000</p> </div>

- Setting the Set Point Lower Limit

<p><b>1</b> Press the  Key several times in the Initial Setting Level to display <b>SL -L</b> (Set Point Lower Limit).</p>	<p>Initial Setting Level</p> <div style="border: 1px solid black; padding: 5px; display: inline-block;"> <p><b>SL -L</b> -200</p> </div> <p>Set Point Lower Limit</p>
<p><b>2</b> Press the  or  Key to set the value to -100. The default is -200.</p>	<div style="border: 1px solid black; padding: 5px; display: inline-block;"> <p><b>SL -L</b> -100</p> </div>

## 5-6 Using the Key Protect Level

### 5-6-1 Protection

- To move to the Protect Level, press the  and  Keys at the same time for at least three seconds\* in the Operation Level, Program Setting Level, Adjustment Level, or PID Setting Level.
  - \* The key pressing time can be changed in the Move to Protect Level Time parameter (Advanced Function Setting Level).
- The Protect Level protects parameters that are not changed during Controller operation until operation is started to prevent them from being modified unintentionally. There are four types of protection: operation/adjustment protect, initial setting/communications protect, setting change protect, and PF Key protect.
- The protect level settings restrict the range of parameters that can be used.

#### ● Operation/Adjustment Protect

The following table shows the relationship between set values and the range of protection.

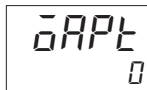

Level		Set value					
		0	1	2	3	4	5
Operation Level	PV	Can be displayed	Can be displayed	Can be displayed	Can be displayed	Can be displayed	Can be displayed
	PV/SP	Can be displayed and changed	Can be displayed and changed	Can be displayed and changed	Can be displayed and changed	Can be displayed and changed	Can be displayed
	Other	Can be displayed and changed	Can be displayed and changed	Can be displayed and changed	Can be displayed and changed	Cannot be displayed and moving to other levels is not possible	Cannot be displayed and moving to other levels is not possible
Program Setting Level		Can be displayed and changed	Can be displayed and changed	Can be displayed and changed	Cannot be displayed and moving to other levels is not possible	Cannot be displayed and moving to other levels is not possible	Cannot be displayed and moving to other levels is not possible
Adjustment Level		Can be displayed and changed	Can be displayed and changed	Cannot be displayed and moving to other levels is not possible	Cannot be displayed and moving to other levels is not possible	Cannot be displayed and moving to other levels is not possible	Cannot be displayed and moving to other levels is not possible
PID Setting Level		Can be displayed and changed	Cannot be displayed and moving to other levels is not possible	Cannot be displayed and moving to other levels is not possible	Cannot be displayed and moving to other levels is not possible	Cannot be displayed and moving to other levels is not possible	Cannot be displayed and moving to other levels is not possible

- Parameters are not protected when the set value is set to 0.
- The default is 0.

### ● Initial Setting/Communications Protect

This protect level restricts movement to the Initial Setting Level, Communications Setting Level, and Advanced Function Setting Level.

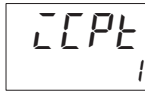

Set value	Initial Setting Level	Communications Setting Level	Advanced Function Setting Level
0	Possible to reach	Possible to reach	Possible to reach
1	Possible to reach	Possible to reach	Not possible to reach
2	Not possible to reach	Not possible to reach	Not possible to reach

- The default is 1.

### ● Setting Change Protect

This protect level restricts key operations

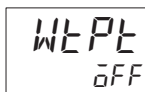

Set value	Description
OFF	Settings can be changed using key operations.
ON	Settings cannot be changed using key operations. (The protect level settings, however, can be changed.)

- The default is OFF.
- The setting change protection indicator (**On**) will light when the Setting Change Protect parameter is set to ON.

### ● PF Key Protect

This protect level enables or disables PF Key operations.



Set value	Description
OFF	PF Key enabled.
ON	PF Key disabled (Operation as function key prohibited).

- The default is OFF.

## 5-6-2 Entering the Password to Move to the Protect Level

- The Protect Level can be moved to only by displaying the password display and entering the correct password. (The user can set any password in the Password to Move to Protect Level parameter.) If no password is set (i.e., if the password is set to 0 in the Password to Move to Protect Level parameter), the password input display to move to the Protect Level will not be displayed and the Protect Level can be moved to directly.







Move to the Protect Level and set the password.

Example password: 1234

### Operating Procedure









#### ● Password Not Yet Set

<p><b>1</b> Press the <b>⏏</b> and <b>⏏</b> Keys simultaneously for at least 3 seconds (default) in the Operation Level.*<sup>1</sup></p> <p>If a password is not set, the Protect Level will be entered and <b>OPPL</b> (Operation/Adjustment Protect) will be displayed.</p>	<p>Protect Level</p> <p>Operation/Adjustment Protect</p>
<p><b>2</b> Press the <b>⏏</b> Key several times in the Protect Level to display <b>PRLP</b> (Password to Move to Protect Level).</p>	<p>Password to Move to Protect Level</p>

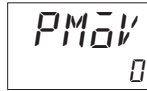

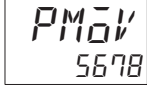



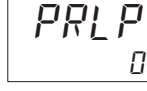

<p><b>3 Press the  and  Keys simultaneously and set the value to 1234. (This enters the password.)</b></p> <p>To prevent setting the password incorrectly, the  and  Keys or  and  Keys must be pressed simultaneously to set the password.</p>	
<p>*1 The key pressing time can be changed in <i>PRLT</i> (Move to Protect Level Time) in the Advanced Function Setting Level. (Setting range: 1 to 30 seconds, Default: 3 seconds)</p>	

## ● Password Already Set

- Deleting the Password (Password Deletion Example: 5678)

<p><b>1 Press the  and  Keys simultaneously for at least 3 seconds (default) in the Operation Level.*1</b></p> <p><i>PMoV</i> (Move to Protect Level) will be displayed.</p>	<p>Protect Level</p>  <p>Move to Protect Level</p>
<p><b>2 Press the  or  Key to set the password to 5678. (This enters the password.)</b></p>	
<p><b>3 Move to the Operation/Adjustment Protect parameter in the Protect Level by pressing the  or  Key or leaving the setting for at least two seconds. (This deletes the password.)</b></p>	 <p>Operation/Adjustment Protect</p>

- Setting the Password Again (Password Example: 1234)

<p><b>1 Set the password to 1234 again.</b></p> <p>Press the  Key several times in the Protect Level to display <i>PRLP</i> (Password to Move to Protect Level).</p>	 <p>Password to Move to Protect Level</p>
<p><b>2 Press the  and  Keys simultaneously and set the value to 1234. (This enters the password.)</b></p> <p>To prevent setting the password incorrectly, the  and  Keys or  and  Keys must be pressed simultaneously to set the password.</p>	
<p>*1 The key pressing time can be changed in <i>PRLT</i> (Move to Protect Level Time) in the Advanced Function Setting Level. (Setting range: 1 to 30 seconds, Default: 3 seconds)</p>	



### **Precautions for Correct Use**

Protection cannot be cleared or changed without the password. Be careful not to forget it. If you forget the password, contact your OMRON sales representative.

## ● Communications Operation Command to Move to the Protect Level

- The Write Variable operation command can be used via communications to write the password to the Move to Protect Level parameter. When the correct password is written, the display will change to the Operation/Adjustment Protect parameter and writing the parameters in the Protect Level will be enabled.

Note 1: If the Write Variable operation command is used to write the wrong password to the Move to Protect Level parameter after the correct parameter has been written, the Move to Protect Level parameter will be displayed and any Write Variable operation commands to write parameters in the Protect Level will result in operation errors.

- 2: If a password is not set or if it is set to 0, the display will change to the Operation/Adjustment Protect parameter and writing the parameters in the Protect Level will be enabled immediately.



## 5-7 Hiding Parameters

### 5-7-1 Parameter Mask Settings

You can use a key operation to hide parameters that do not need to be displayed. This allows you to prevent incorrect settings for parameters or to simplify the parameter configuration according to the application.

#### ● Parameters



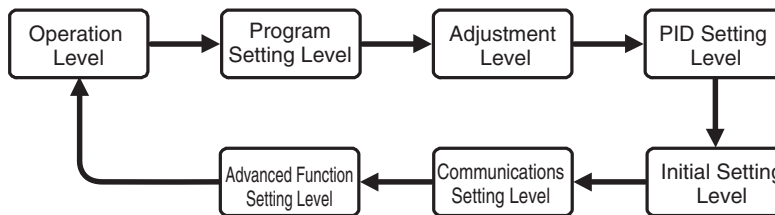

Display	Parameter	Application	Level
<i>PMSL</i>	Parameter Mask Settings	Moves you to the Parameter Mask Mode.	Advanced Function Setting Level
<i>PMSK</i>	Parameter Mask Enable	Enables and disables parameter masks.	Protect Level

#### ● Description

- If you set the Parameter Mask Setting parameter (Advanced Function Setting Level) to ON, Parameter Mask Mode is entered.
- When you enter Parameter Mask Mode, the first parameter in the Operation Level is displayed.
- When you press the  Key, the setting level changes as shown below.



\* You cannot mask parameters in the Manual Control Level, Monitor/Setting Item Level, and Protect Level.



- Press the  Key once for less than one second to move to the next parameter in the current setting level.  
Press the  Key for at least one second to move to the previous parameter in the current setting level.
- Press the  or  Key to set *dLSP* (disable mask (show)) or *MASK* (enable mask (hide)).
- Perform one of the following operations to end Parameter Mask Mode.
  1. Cycle the power supply.
  2. Send a Software Reset command with communications.
  3. Press  Key for at least one second.
- When you enter Parameter Mask Mode, the first parameter in the Operation Level is displayed. However, you cannot set a parameter mask for the Process Value/Set Point 1 and Process Value/Set Point 2 parameters.

## ● Setting Example

In this example, the SP Mode parameter in the Adjustment Level is set to *MASK* (mask (hide)).





### Operating Procedure

#### ● Moving to Parameter Mask Mode (Advanced Function Setting Level)

<p><b>1</b> Press the  Key several times in the Advanced Function Setting Level to display the Parameter Mask Setting parameter.</p>	<p>Advanced Function Setting Level</p> <div style="display: flex; align-items: center;"> <div style="border: 1px solid black; padding: 5px; margin-right: 10px;"> <i>PMSL</i>  <math>\bar{a}FF</math> </div> <p>Parameter Mask Settings</p> </div>
<p><b>2</b> Press the  or  Key to set <math>\bar{a}N</math> (move to Parameter Mask Mode). The default is <math>\bar{a}FF</math>.</p>	<div style="border: 1px solid black; padding: 5px; width: fit-content;"> <i>PMSL</i>  <math>\bar{a}N</math> </div>



Refer to 4-1-6 Moving to the Advanced Function Setting Level for the procedure to enter the Advanced Function Setting Level.

#### ● Hiding the SP Mode Parameter (Adjustment Level)

<p><b>1</b> Press the  Key several times in the Adjustment Level to select the SP Mode parameter.</p>	<p>Adjustment Level</p> <div style="display: flex; align-items: center;"> <div style="border: 1px solid black; padding: 5px; margin-right: 10px;"> <i>SPMd</i>  <math>d\bar{c}SP</math> </div> <p>SP Mode</p> </div>
<p><b>2</b> Press the  or  Key to set <i>MASK</i> (mask (hide)). The default is <math>d\bar{c}SP</math>.</p>	<div style="border: 1px solid black; padding: 5px; width: fit-content;"> <i>SPMd</i>  <i>MASK</i> </div>
<p><b>3</b> Press the  Key for at least 1 second to end Parameter Mask Mode.</p>	

Refer to 4-1-3 Moving to the Adjustment Level for the procedure to enter the Adjustment Level.

#### ● Enabling Parameter Masks (Protect Level)

<p><b>1</b> Press the  Key several times in the Protect Level to display the Parameter Mask Enable parameter.</p>	<p>Protect Level</p> <div style="display: flex; align-items: center;"> <div style="border: 1px solid black; padding: 5px; margin-right: 10px;"> <i>PMSK</i>  <math>\bar{a}N</math> </div> <p>Parameter Mask Enable</p> </div>
<p><b>2</b> Press the  or  Key to set <math>\bar{a}N</math> (enable). The default is <math>\bar{a}N</math>. *The SP Mode parameter is masked (i.e., hidden).</p>	<div style="border: 1px solid black; padding: 5px; width: fit-content;"> <i>PMSK</i>  <math>\bar{a}N</math> </div>

Refer to 4-1-5 Moving to the Protect Level for the procedure to enter the Protect Level.

## 5-8 OR Output of Alarms

### 5-8-1 Integrated Alarm

You can use an integrated alarm to output an OR of alarms 1 to 4, the HB alarm, the HS alarm, and the input error. Set the Integrated Alarm Assignment parameter (*ALM*) and then assign the integrated alarm (*ALM*) to an auxiliary output or a control output.

#### ● Parameters

Parameter	No. 1 display	Value	No. 2 display	Level
Control Output Assignment	<i>OUT1</i> to <i>OUT2</i>	ALM: Integrated alarm (The Integrated Alarm Assignment parameter must be set separately.)	<i>ALM</i>	Advanced Function Setting Level
Auxiliary Output 1 to 4 Assignment	<i>SUB1</i> to <i>SUB4</i>	ALM: Integrated alarm (The Integrated Alarm Assignment parameter must be set separately.)	<i>ALM</i>	Advanced Function Setting Level
Integrated Alarm Assignment	<i>ALM</i>	Set the sum of the following values for the alarms and errors to include in the OR output. 0 to 255 Alarm 1: +1 Alarm 2: +2 Alarm 3: +4 Alarm 4: +8 HB alarm: +16 HS alarm: +32 Input error: +64 Not used.: +128 (Default: 49 (i.e., an OR of alarm 1, the HB alarm, and the HS alarm))	0 to 255	Advanced Function Setting Level

● **Operating Procedure**







The following procedure outputs an OR of the following alarms on auxiliary output 2.

- Alarm 1
- HB alarm (*Hb*)

The settings are made in the Advanced Function Setting Level.

**Operating Procedure**

- Assigning the Integrated Alarm to an Auxiliary Output

<p><b>1</b> Press the  Key several times in the Advanced Function Setting Level to display <i>SUB2</i> (Auxiliary Output 2 Assignment).</p>	<p>Advanced Function Setting Level</p> <div style="border: 1px solid black; padding: 5px; display: inline-block;"> <p><i>SUB2</i> <i>ALM2</i></p> </div> <p>Auxiliary Output 2 Assignment</p>
<p><b>2</b> Press the  or  Key to select <i>ALM</i> (Integrated Alarm). The default is <i>ALM2</i> (Alarm 2).</p>	<div style="border: 1px solid black; padding: 5px; display: inline-block;"> <p><i>SUB2</i> <i>ALM</i></p> </div>
<p>• Setting the Integrated Alarm Assignment Parameter</p>	
<p><b>1</b> Press the  Key several times in the Advanced Function Setting Level to display <i>ALMA</i> (Integrated Alarm Assignment).</p>	<p>Advanced Function Setting Level</p> <div style="border: 1px solid black; padding: 5px; display: inline-block;"> <p><i>ALMA</i> 49</p> </div> <p>Integrated Alarm Assignment</p>
<p><b>2</b> Press the  or  Key to set the set value to 17 (i.e., the sum of 1 for alarm 1 and 16 for the HB alarm). The default is 49. (Alarm 1 (1) + HB alarm (16) + HS Alarm (32)= 49)</p>	<div style="border: 1px solid black; padding: 5px; display: inline-block;"> <p><i>ALMA</i> 17</p> </div>



**Additional Information**

For details on the integrated alarm, refer to *Section 6 Parameters*.

## 5-9 Alarm Delays

### 5-9-1 Alarm Delays

- Delays can be set for the alarm outputs. ON and OFF delays can be set separately for alarms 1, 2, 3, and 4. The ON and OFF delays for alarms 1, 2, 3, and 4 also apply to the individual SUB1, SUB2, SUB3, and SUB4 indicators and to communications status. The alarm ON delays will also function when power is turned ON or when moving from the Initial Setting Level to Operation Level (e.g., to software resets). All outputs will turn OFF and the OFF delays will not function when moving to the Initial Setting Level or when an alarm is output for an A/D converter error.

#### ● Operation of Alarm ON and OFF Delays (for an Upper-limit Alarm)

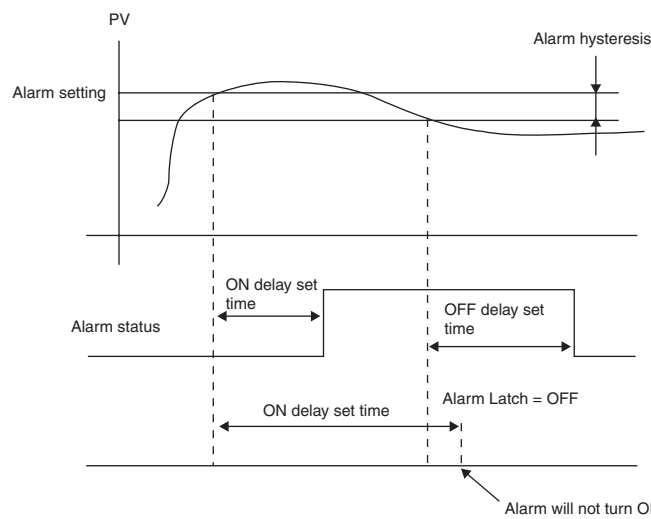

- The alarm will not turn ON if the time that the alarm is ON is equal to or less than the ON delay set time. Also, the alarm will not turn OFF if the time that the alarm is OFF is equal to or less than the OFF delay set time.
- If an alarm turns OFF and then back ON during the ON delay time, the time will be remeasured from the last time the alarm turns ON. Also, if an alarm turns ON and then back OFF during the OFF delay time, the time will be remeasured from the last time the alarm turns OFF.

#### ● Parameters Related to Alarm Delays

Parameter name	Display	Set (monitor) values	Level
Alarm 1 ON Delay	R1 $\bar{O}N$	0 to 999 (s)	Advanced Function Setting Level
Alarm 2 ON Delay	R2 $\bar{O}N$	0 to 999 (s)	
Alarm 3 ON Delay	R3 $\bar{O}N$	0 to 999 (s)	
Alarm 4 ON Delay	R4 $\bar{O}N$	0 to 999 (s)	
Alarm 1 OFF Delay	R1 $\bar{O}F$	0 to 999 (s)	
Alarm 2 OFF Delay	R2 $\bar{O}F$	0 to 999 (s)	
Alarm 3 OFF Delay	R3 $\bar{O}F$	0 to 999 (s)	
Alarm 4 OFF Delay	R4 $\bar{O}F$	0 to 999 (s)	



Note 1: The defaults are 0, i.e., the ON and OFF delays are disabled.

Note 2: The parameters are displayed when alarm functions are assigned and when the alarm type is set to any type but 0 (none), 12: LBA, or 13: PV change rate alarm.

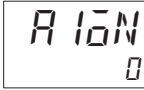

Use the following procedure to set ON and OFF delays for the alarm 1.  
An ON delay of 5 seconds and an OFF delay of 10 s will be set.

**Operating Procedure**

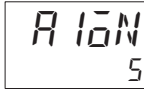
- Setting the Alarm 1 ON Delay

<p><b>1</b> Press the  Key several times in the Advanced Function Setting Level to display <i>R l̄N</i> (Alarm 1 ON Delay).</p>	<p>Advanced Function Setting Level</p>  Alarm 1 ON Delay
<p><b>2</b> Press the  or  Key to set the value to 5. The default is 0.</p>	

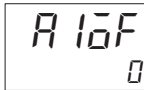
- Setting the Alarm 1 OFF Delay

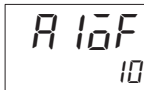
<p><b>1</b> Press the  Key several times in the Advanced Function Setting Level to display <i>R l̄F</i> (Alarm 1 OFF Delay).</p>	<p>Advanced Function Setting Level</p>  Alarm 1 OFF Delay
<p><b>2</b> Press the  or  Key to set the value to 10. The default is 0.</p>	

## 5-10 Loop Burnout Alarm (Not Supported for Position-proportional Models.)

### 5-10-1 Loop Burnout Alarm (LBA)

- With a loop burnout alarm, there is assumed to be an error in the control loop if the control deviation (SP - PV) is greater than the threshold set in the LBA Level parameter and if the control deviation is not reduced by at least the value set in the LBA Detection Band parameter within the LBA detection time.
- Loop burnout alarms are detected at the following times.

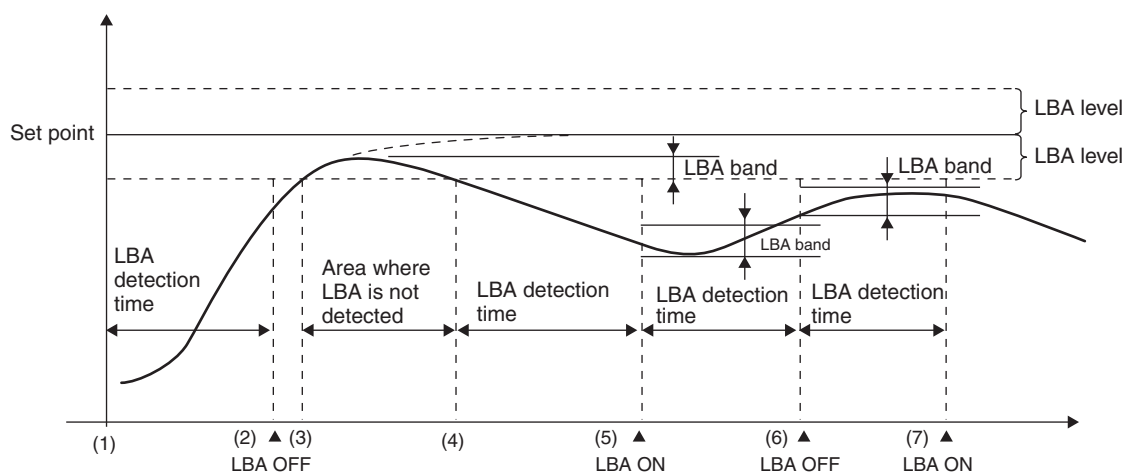

If the control deviation is reduced in the area between 1 and 2 (i.e., the set point is approached) and the amount the control deviation is reduced is at least equal to the LBA band, the loop burnout alarm will remain OFF.

The process value is within the LBA level between 3 and 4, and thus loop burnout alarms will not be detected. (The loop burnout alarm will remain OFF.)

If the process value is outside the LBA level between 4 and 5 and the control deviation is not reduced by at least the LBA band within the LBA detection time, the loop burnout alarm will turn ON.

If the control deviation is reduced in the area between 5 and 6 (i.e., the set point is approached) and the amount the control deviation is reduced is at least equal to the LBA band, the loop burnout alarm will turn OFF.

If the control deviation is reduced in the area between 6 and 7 (i.e., the set point is approached) and the amount the control deviation is reduced is less than the LBA band, the loop burnout alarm will turn ON.

- If the LBA detection time, LBA level, LBA detection band, and PID settings are not appropriate, alarms may be detected inappropriately or alarms may not be output when necessary.
- Loop burnout alarms may be detected if unexpectedly large disturbances occur continuously and a large deviation does not decrease.
- If a loop burnout occurs when the set point is near the ambient temperature, the temperature deviation in a steady state may be less than the LBA level, preventing detection of the loop burnout.
- If the set point is so high or low that it cannot be reached even with a saturated manipulated variable, a temperature deviation may remain even in a steady state and a loop burnout may be detected.
- Detection is not possible if a fault occurs that causes an increase in temperature while control is being applied to increase the temperature (e.g., an SSR short-circuit fault).

- Detection is not possible if a fault occurs that causes a decrease in temperature while control is being applied to decrease the temperature (e.g., a heater burnout fault).

● **Parameters Related to Loop Burnout Alarms**

Parameter name	Display	Setting range		Remarks	Level
PID * LBA Detection Time (*: 1 to 8)	*LbA	0 to 9,999 (s)		Setting 0 disables the LBA function.	PID Setting Level (for PID control)
LBA Detection Time	LbA				Advanced Function Setting Level (for ON/OFF control)
LBA Level	LbAL	Temperature input	0.1 to 999.9 (°C/°F)	Default: 8.0 (°C/°F)	Advanced Function Setting Level
		Analog input	0.01 to 99.99 (%FS)	Default: 10.00% FS	
LBA Band	LbAb	Temperature input	0.0 to 999.9 (°C/°F)	Default: 3.0 (°C/°F)	
		Analog input	0.00 to 99.99 (%FS)	Default: 0.20% FS	

- A loop burnout alarm can be output by setting the alarm 1 type to 12 (LBA).
- A setting of 12 (LBA) can be set for alarms 2 to 4, but the setting will be disabled.
- Loop burnouts are not detected during autotuning or manual operation.
- If the Reset Operation parameter is set to stop control, loop burnout alarms are not detected during reset or standby status.
- If the alarm 1 latch is set to ON, the latch will be effective for the loop burnout alarm.

● **Automatically Setting the LBA Detection Time**

- The LBA detection time is automatically set by auto-tuning. (It is not set automatically, however, for heating/cooling control.)
- If the optimum LBA detection time is not obtained by auto-tuning, set the LBA Detection Time parameter (Advanced Function Setting Level).

● **Determining the LBA Detection Time**

- To manually set the LBA detection time, set the LBA Detection Time parameter to twice the LBA reference time given below.

(1) **Set the output to the maximum value.**

(2) **Measure the time required for the width of change in the input to reach the LBA band.**

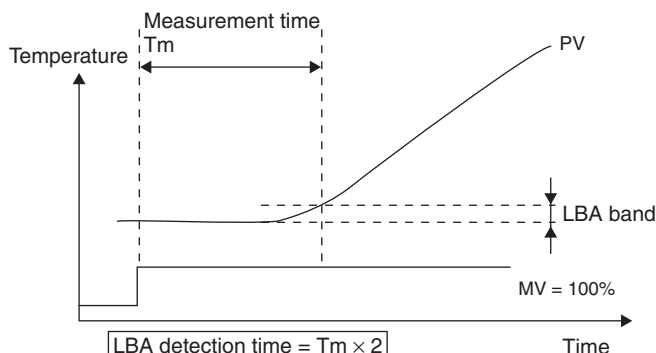

(3) **Set the LBA Detection Time parameter to two times the measured time.**



## ● LBA Level

- Set the control deviation when the control loop is working properly.
- The default is 8.0 (°C/°F) for Controllers with Temperature Inputs and 10.00% FS for Controllers with Analog Inputs.

## ● LBA Band

- There is assumed to be an error in the control loop and the alarm output turns ON if the control deviation is greater than the threshold set in the LBA Level parameter and if the control deviation does not change by at least the value set in the LBA Band parameter.
- The default is 3.0 (°C/°F) for Controllers with Temperature Inputs and 0.20% FS for Controllers with Analog Inputs.

The LBA is used.

The related parameters are as follows:











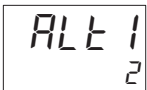

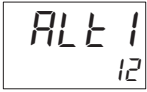
LBA Detection Time: 10

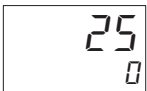

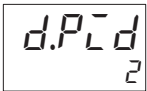

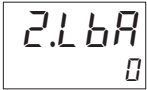

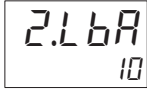
LBA Level: 8.0

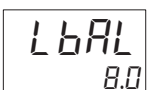
LBA Band: 3.0

### Operating Procedure

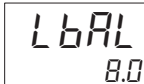
- Setting the LBA

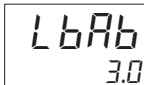
<p><b>1</b> Press the  Key several times in the Initial Setting Level to display <i>AL1</i> (Alarm 1 Type).</p>	<p>Initial Setting Level</p>  Alarm 1 Type
<p><b>2</b> Press the  or  Key to select <i>12</i> (LBA). The default is <i>2</i> (upper limit).</p>	
<ul style="list-style-type: none"> <li>• Setting the LBA Detection Time</li> </ul>	
<p><b>1</b> Press the  Key to move from Operation Level to PID Setting Level.</p>	<p>Operation Level</p>  Process Value/ Set Point
<p><b>2</b> The currently selected PID set number is displayed. Press the  or  Key to select 2.</p>	<p>PID Setting Level</p>  Display PID Selection
<p><b>3</b> Press the  Key several times in the PID Setting Level to display <i>LbA</i> (LBA Detection Time).</p>	<p>PID Setting Level</p>  PID2 LBA Detection Time
<p><b>4</b> Press the  or  Key to set 10. The default is 0 (s).</p>	
<ul style="list-style-type: none"> <li>• Setting the LBA Level</li> </ul>	
<p><b>1</b> Press the  Key several times in the Advanced Function Setting Level to display <i>LbAL</i> (LBA Level).</p>	<p>Advanced Function Setting Level</p>  LBA Level

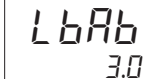
<p><b>2</b> Press the  or  Key to set the value to 8.0. The default is 8.0 (°C/°F).</p>	
<p>• Setting the LBA Band</p>	
<p><b>1</b> Press the  Key several times in the Advanced Function Setting Level to display <i>LbAb</i> (LBA Band).</p>	<p>Advanced Function Setting Level</p>  <p>LBA Band</p>
<p><b>2</b> Press the  or  Key to set the value to 3.0. The default is 3.0 (°C/°F).</p>	

## 5-11 Performing Manual Control

You can perform manual operation with PID control or with a Position-proportional Model.

### 5-11-1 Manual MV

#### ● Standard Models and Position-proportional Models (Close Control with Direct Setting of Position Proportional MV Parameter Set to ON)

If you change to Manual Mode, the Manual MV parameter will be displayed and the displayed value will be output as the MV. If you change the setting of the Manual MV parameter, you can set any required MV. (The new value will be applied immediately.) The default setting of the Manual MV parameter is determined by the setting of the Manual Output Method parameter as shown below.

HOLD: The MV from immediately before moving to Manual Mode

INIT: The set value of the Manual MV Initial Value parameter

If the power supply is cycled during manual operation, operation will be restarted with the manual MV that was in effect before the power supply was interrupted. When the Manual MV Limit Enable parameter is set to ON (enable), the setting range will be from the MV lower limit to the MV upper limit. When operation is changed back to Automatic Mode, the MV from immediately before the change is inherited and then gradually changes to the value for Automatic Mode to prevent the MV from changing rapidly. (This is called balanceless-bumpless operation.)

The manual operation is illustrated in the following figure when the Manual Output Method parameter is set to HOLD.

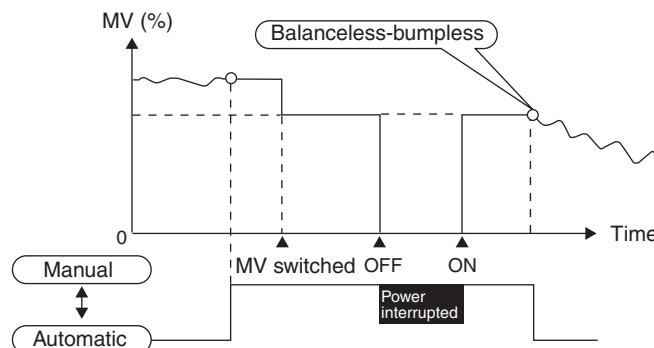

For a Position-proportional Model, the manual MV changes as shown below when there is a potentiometer input error.

Manual MV Limit Enable Parameter Set to OFF

Manual MV  $\geq$  100: Open output turns ON.

Manual MV  $\leq$  0: Close output turns ON.

For any other manual MV, both the open output and close output will turn OFF.

Manual MV Limit Enable Parameter Set to ON

Manual MV = MV upper limit: Open output turns ON.

Manual MV = MV lower limit: Close output turns ON.

For any other manual MV, both the open output and close output will turn OFF.

#### ● Position-proportional Models (Floating Control or Direct Setting of Position Proportional MV Parameter Set to OFF)

Press the Up Key to turn ON the open output. Press the Down Key to turn ON the close output. For close control, you can also use a manual MV limit. In this case, the MV limit operates for the valve opening.



**Precautions for Correct Use**

- The automatic display return function will not operate in Manual Mode.
- Switching between automatic and manual operation is possible for a maximum of one million times.

● **Related Displays and Parameters**

Parameter name	Display	Setting range	Default	Level
Auto/Manual Switch	<i>A-M</i>	Switching between Automatic Mode and Manual Mode	---	Operation Level
PV/MV (Manual MV)	---	Standard control or position-proportional control: -5.0 to 105.0 Heating/cooling control: -105.0 to 105.0*	---	Manual Control Level
Manual Output Method	<i>MANL</i>	HOLD INIT	HOLD	Advanced Function Setting Level
Manual MV Initial Value	<i>MANL</i>	Standard control or position-proportional control: -5.0 to 105.0 Heating/cooling control: -105.0 to 105.0*	0.0	
Manual MV Limit Enable	<i>MANL</i>	OFF: Disabled. ON: Enabled.	OFF	
Direct Setting of Position-proportional MV	<i>PMVd</i>	OFF: Disabled. ON: Enabled.	OFF	



\* If the Manual MV Limit Enable parameter is set to ON, this value will be between the MV upper limit and the MV lower limit.

Note: Refer to 5-16 *Output Adjustment Functions* for information on the order of priority for the MV.

● **Moving to the Manual Control Level**

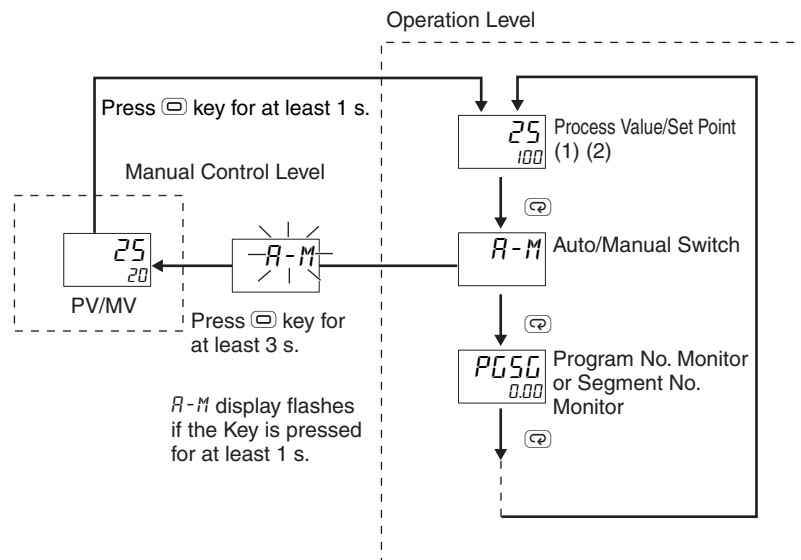
- Moving with a Key Operation
  - When the Key is pressed for at least 3 seconds in the Operation Level's auto/manual switching display, the Manual Mode will be entered and the Manual Control Level will be displayed. It is not possible to move to any displays except for the PV/MV parameter during manual operation. Press the Key for at least one second from the PV/MV parameter display in Manual Control Level to return to Automatic Mode and display the top parameter in the Operation Level.
  - \* For details, refer to 5-7 *Hiding Parameters* for information on masking the Auto/Manual Switch parameter.



- Using the PF Key to Move to the Manual Control Level
  - If the PF Setting parameter is set to A-M (auto/manual), you can change to manual operation (Manual Control Level) by pressing the PF Key for at least one second from the Operation Level, Program Setting Level, Adjustment Level, or PID Setting Level. During manual operation it is not possible to move to any displays other than PV/MV (Manual MV). Press the  or  Key for at least one second from the PV/MV display in the Manual Control Level to change the mode to Automatic Mode, move to the Operation Level, and display the top parameter in the Operation Level.

Note 1: Priority of Manual MV and Other Functions

Even when the program is in reset status, the manual MV is given priority.  
Autotuning will stop if you change to manual operation.

2: Manual Operation and Program Operation

Timing will continue when you move to manual operation during program operation.





- Moving to the Manual Control Level with an Event Input
  - If an event input is set to MANU (auto/manual), you can use the event input to switch between Automatic Mode and Manual Mode.

We will set the PF Setting parameter to A-M (auto/manual).



If the PID ON/OFF parameter is set to ON/OFF, you must change the setting to PID.

### Operating Procedure

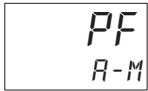
- Setting Auto/Manual Switching

<p><b>1</b> Press the  Key several times in the Advanced Function Setting Level to display PF (PF Setting).</p>	<p>Advanced Function Setting Level</p>  <p>PF Setting</p>
<p><b>2</b> Press the  or  Key to select A-M (auto/manual).</p>	

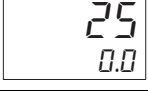
- Setting the Manual MV with the  Key

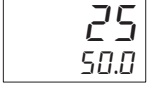
<p><b>1</b> Press the  Key in the Operation Level to enter the Manual Control Level.</p>	<p>Operation Level</p>  <p>PV/MV</p>
<p><b>2</b> Press the  or  Key to set the manual MV. (In this example, the MV is set to 50%.)*<sup>1</sup></p>	

\*<sup>1</sup> The manual MV setting must be saved (see page *Applying Changes to Numeric Values* on page 3-8), but values changed with key operations are reflected in the control output immediately.

# 5-12 Using the Transfer Output

## 5-12-1 Transfer Output Function

A transfer output can be used on models that have a transfer output.

### ● Precision and User Calibration

Precision	User calibration
±0.3% FS	Supported.*

\* For details on calibration, refer to *Section 6 Parameters*.

### Transfer Output Signal (Initial Setting Level)

You can use the Transfer Output Signal parameter to specify whether to output a current or voltage from the transfer output.

### Terminal Arrangement

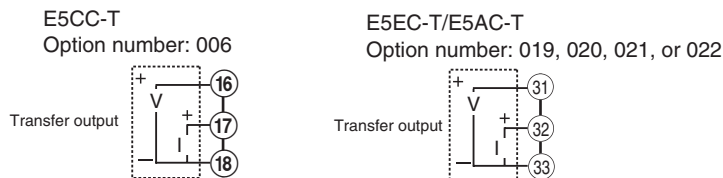

Setting range	Default
4-20: 4 to 20mA	4-20
1-5V: 1-5 V	

### ● Transfer Output Type (Initial Setting Level)

You can use the Transfer Output Type parameter to specify any of five types of data to output.

Transfer output type	Display	Setting range
OFF (default)	OFF	---
Present SP	SP-M	SP lower limit to SP upper limit
PV	PV	Input setting range lower limit to input setting range upper limit or Scaling lower limit to scaling upper limit
MV monitor (heating) *1	MV	-5.0 to 105.0 (heating/cooling control: 0.0 to 105.0)
MV monitor (cooling) *2	C-MV	0.0 to 105.0
Valve opening *3	V-M	-10.0 to 110.0

\*1 This function can be set for a Position-proportional Model, but the setting will be disabled.

\*2 This function can be set for standard control or for a Position-proportional Model, but the setting will be disabled.

\*3 This parameter is displayed only for a Position-proportional Model.

## ● Transfer Scaling

- Reverse scaling is possible by setting the Transfer Output Lower Limit parameter larger than the Transfer Output Upper Limit parameter. If the Transfer Output Lower Limit and Transfer Output Upper Limit parameters are set to the same value, the transfer output will be output continuously at 0%.
- If the present SP or PV is selected, the Transfer Output Upper Limit and Transfer Output Lower Limit parameters will be forcibly initialized to the respective upper and lower setting limits if any of the following parameters is changed: Input Type, Scaling Upper Limit, Scaling Lower Limit, Set Point Upper Limit, Set Point Lower Limit, or Temperature Unit.  
If the MV for heating or MV for cooling is selected, the Transfer Output Lower Limit and Transfer Output Upper Limit parameters will be initialized to 100.0 and 0.0, respectively, when a switch is made between standard control and heating/cooling control using the Standard or Heating/Cooling parameter.
- The output current when transfer output signal is set to 4 to 20 mA, the transfer output upper limit is set to 90.0, and the transfer output lower limit is set to 10.0 is shown in the following graph.
- For scaling from 0.0% to 100.0%, the output for -5.0 to 0.0 will be the same value as for 0.0%, and the output for 100.0 to 105.0 will be the same value as for 100.0%

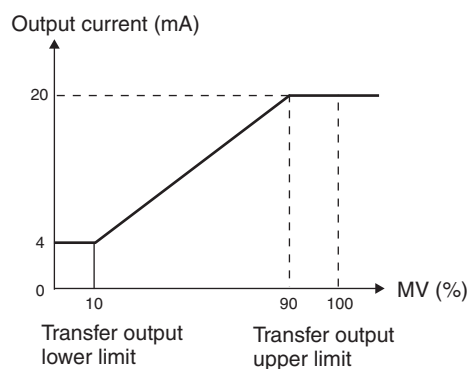



(The above graph is for when transfer output signal is set to 4 to 20 mA.)



The following procedure sets the transfer output for an SP range of -50 to 200.

**Operating Procedure**



- Setting the Transfer Output Type

<p><b>1</b> Press the  Key several times in the Initial Setting Level to display <math>TR-T</math> (Transfer Output Type).</p>	<p>Initial Setting Level</p> <div style="border: 1px solid black; padding: 5px; display: inline-block;"> <math>TR-T</math>  <math>OFF</math> </div> <p>Transfer Output Type</p>
<p><b>2</b> Press the  or  Key to select <math>SP-M</math> (present SP). The default is <math>OFF</math>.</p>	<div style="border: 1px solid black; padding: 5px; display: inline-block;"> <math>TR-T</math>  <math>SP-M</math> </div>

- Setting the Transfer Output Upper Limit

<p><b>1</b> Press the  Key several times in the Initial Setting Level to display <math>TR-H</math> (Transfer Output Upper Limit).</p>	<p>Initial Setting Level</p> <div style="border: 1px solid black; padding: 5px; display: inline-block;"> <math>TR-H</math>  <math>1300</math> </div> <p>Transfer Output Upper Limit</p>
<p><b>2</b> Press the  or  Key to set the value to 200. The default is 1300.</p>	<div style="border: 1px solid black; padding: 5px; display: inline-block;"> <math>TR-H</math>  <math>200</math> </div>

- Setting the Transfer Output Lower Limit

<p><b>1</b> Press the  Key several times in the Initial Setting Level to display <math>TR-L</math> (Transfer Output Lower Limit).</p>	<p>Initial Setting Level</p> <div style="border: 1px solid black; padding: 5px; display: inline-block;"> <math>TR-L</math>  <math>-200</math> </div> <p>Transfer Output Lower Limit</p>
<p><b>2</b> Press the  or  Key to set the value to -50. The default is -200.</p>	<div style="border: 1px solid black; padding: 5px; display: inline-block;"> <math>TR-L</math>  <math>-50</math> </div>



## 5-13 Using PID Sets

### 5-13-1 PID Sets



One set of all the parameters that are related to 2-PID control are called a PID set.

- You can register up to eight PID sets.
- There are the following two ways that you can specify PID sets.
  - Setting a Fixed PID Set
  - Using Automatic Selection of PID Sets by Zone
- You can specify the PID set selection method for each program in the PID Set No. parameter in the Program Setting Level.
- The same PID sets are used for all programs.

#### ● Related Parameters

- Parameter Used to Select the PID Set to Edit

Parameter name	Display	Setting range	Unit	Default	Level
Display PID Selection (PID Set)	<i>d.Pid</i>	1 to 8	---	Currently selected PID set*	PID Setting Level

\*If you press the  or  Key to change the PID set number, the current set number is no longer monitored.

- PID Set Parameters

\* = Set number 1 to 8

Parameter name	Display	Setting range		Unit	Default	Level	
PID * Proportional Band	*.P	Temperature input: 0.1 to 999.9		°C or °F	8.0	PID Setting Level	
		Analog input: 0.1 to 999.9		%FS	10.0		
PID * Integral Time *1	*.I	Integral/Derivative Time Unit of 1 s	Standard, heating/cooling, or close position-proportional control: 0 to 9999	Seconds	233		
			Floating position-proportional control: 1 to 9999				
		Integral/Derivative Time Unit of 0.1 s	Standard, heating/cooling, or close position-proportional control: 0.0 to 999.9	Seconds	233.0		
			Floating position-proportional control: 0.1 to 999.9				
PID * Derivative Time *1	*.d	Integral/Derivative Time Unit of 1 s	0 to 9999	Seconds	40		
		Integral/Derivative Time Unit of 0.1 s	0.0 to 999.9		40.0		
PID * Proportional Band (Cooling) *1	*.I - P	Same as PID * Proportional Band.					

Parameter name	Display	Setting range	Unit	Default	Level
PID * Integral Time (Cooling) <sup>*1</sup>	*.I - $\bar{t}$	Same as PID * Integral Time.			PID Setting Level
PID * Derivative Time (Cooling) <sup>*1</sup>	*.I - $d$	Same as PID * Derivative Time.			
PID * Dead Band <sup>*1</sup>	*.I db	Temperature input: - 199.9 to 999.9	°C or °F	0.0	
		Analog input: - 19.99 to 99.99	%FS	0.00	
PID * Manual Reset Value <sup>*1</sup>	*.dFR	0.0 to 100.0	%	50.0	
PID * MV Upper Limit <sup>*1</sup>	*.dLH	Standard, close position-proportional: MV lower limit + 0.1 to 105.0	%	100.0	
		Heating/cooling: 0.0 to 105.0	%	100.0	
PID * MV Lower Limit <sup>*1</sup>	*.dLL	Standard, close position-proportional: - 5.0 to MV upper limit - 0.1	%	0.0	
		Heating/cooling: - 105.0 to 0.0		- 100.0	
PID * Automatic Selection Range Upper Limit <sup>*2</sup>	*.AUT	Temperature input: - 1999 to 9999	EU	1320	
		Analog input: - 5.0 to 105.0	% <sup>*3</sup>	105.0	
PID * LBA Detection Time	*.LbR	0 to 9999 (0: LBA function disabled)	Seconds	0	

\*1 If you change the same parameters in the Adjustment Level, they will apply to the parameters in the currently selected PID set.

\*2 You cannot set this parameter in PID set 8. For a temperature input with a sensor setting range, it will always be set to the upper limit of the input indication range. For an analog input, it will always be set to 105.0%.

\*3 Set the value to between 0% and 100% of the input setting range. If the PID Set Automatic Selection Data parameter is set to DV, the unit is %FS.

• Parameters for Specifying Automatic Selection of PID Sets

Parameter name	Display	Setting range	Unit	Default	Level
PID Set No.	P $\bar{c}$ d	0: Automatic selection 1 to 8: PID set number for manual setting	---	1	Program Setting Level
PID * Automatic Selection Range Upper Limit (*: set number 1 to 7)	*.AUT (*: 1 to 7)	Temperature input: - 1999 to 9999	EU	1320	PID Setting Level
		Analog input: - 5.0 to 105.0	%	105.0 <sup>*1</sup>	
PID Set Automatic Selection Data	P $\bar{c}$ d $\bar{c}$	PV: Automatic selection with PV dV: Automatic selection with deviation (PV - SP) SP: Automatic selection with SP	---	PV	Advanced Function Setting Level
PID Set Automatic Selection Hysteresis	P $\bar{c}$ dH	0.10 to 99.99	%FS	0.50	Advanced Function Setting Level

\*1 Set the value to between 0% and 100% of the input setting range. If the PID Set Automatic Selection Data parameter is set to DV, the unit is %FS.

## Setting a Fixed PID Set

You can set any of the PID sets from 1 to 8.

Specify the PID set number between 1 and 8 in the PID Set No. parameter in the Program Setting Level. (The default is 1.)

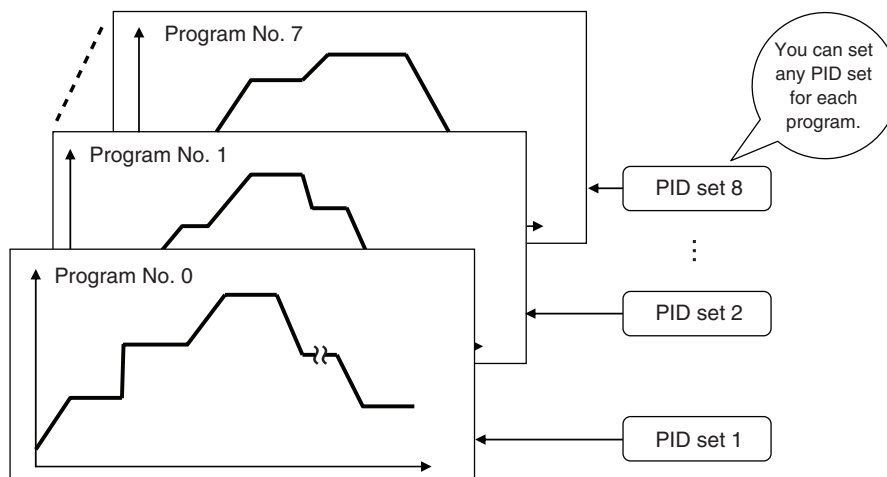

## Using Automatic Selection of PID Sets by Zone

You can set the PID Set No. parameters in the Program Setting Level to 0 (automatic selection) to automatically select PID sets by zones.

- The PID set is automatically set according to which of the preset zones contains the PV (process value), SP (set point), or DV (deviation) (as specified in the PID Set Automatic Selection Data parameter).
- Set the upper limit of each zone as the automatic selection range upper limit for each PID set. Set the upper limits so that they increase with the higher PID set numbers. The PID sets will be disabled if the set values are in the reverse order.
- To prevent chattering when changing between PID sets, you can set hysteresis in the PID Set Automatic Selection Hysteresis parameter.

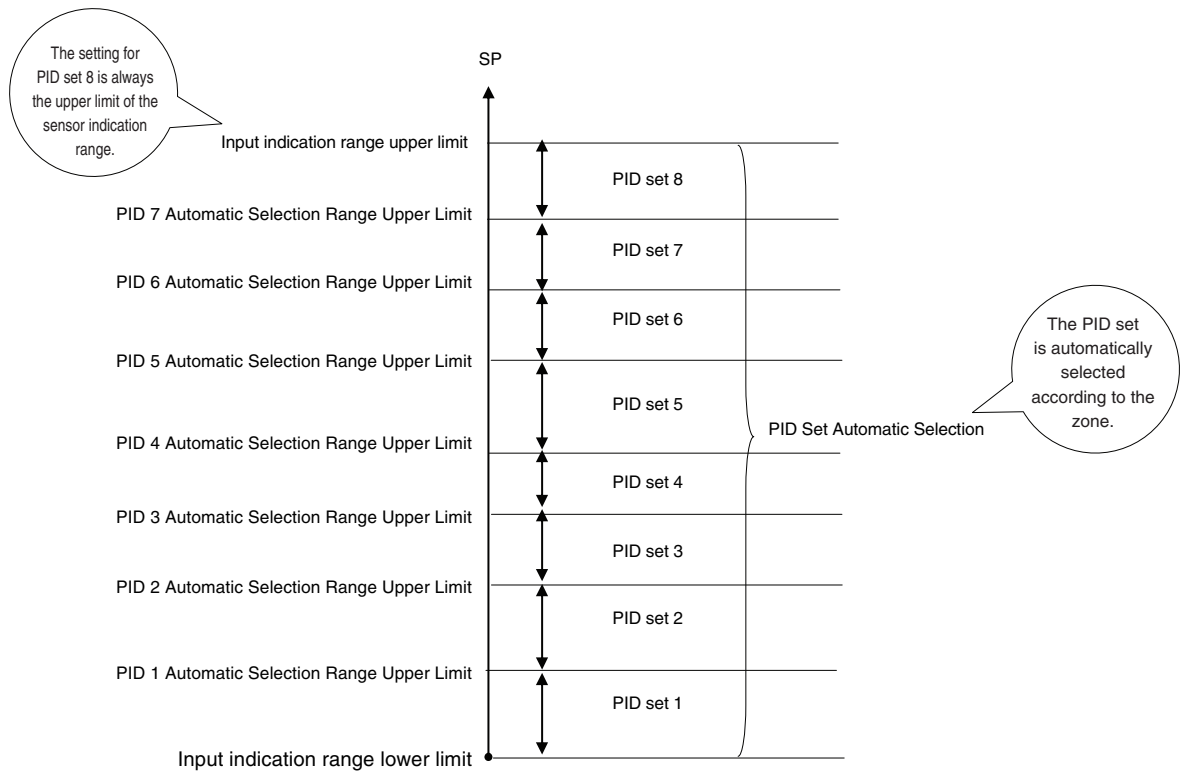

## 5-13-2 Settings for PID Sets

This section describes the procedures to make settings to use fixed PID sets and to use automatic selection of PID sets according to zones.







### Using Fixed PID Sets

#### Setting Example

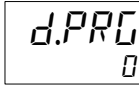
This example shows how to set PID set 1 for program 0.

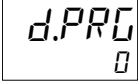
#### Operating Procedure

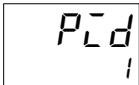
##### ● Specifying the PID Set Number (Program Setting Level)

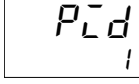
<p><b>1</b> Move to the Program Setting Level. The Display Program Selection parameter is displayed.</p>	<p>Program Setting Level</p>  <p>Display Program Selection</p>
<p><b>2</b> Press the  or  Key to select 0. The default is the currently selected program number.</p>	
<p><b>3</b> Press the  Key several times to select the PID Set No. parameter.</p>	<p>Program Setting Level</p>  <p>PID Set No.</p>
<p><b>4</b> Press the  or  Key to select 1. The default is 1.</p>	

## Using Automatic Selection of PID Sets by Zone

### Setting Example

In this example, automatic selection is specified for program 0 and then settings are made to automatically select PID sets 1 to 8 according to the following PV (process value) zones.

Parameter name	Set value	Unit	Level
PID Set Automatic Selection Data	PV	---	Advanced Function Setting Level
PID 1 Automatic Selection Range Upper Limit	200	°C	PID Setting Level
PID 2 Automatic Selection Range Upper Limit	400		
PID 3 Automatic Selection Range Upper Limit	500		
PID 4 Automatic Selection Range Upper Limit	600		
PID 5 Automatic Selection Range Upper Limit	700		
PID 6 Automatic Selection Range Upper Limit	800		
PID 7 Automatic Selection Range Upper Limit	1000		
PID 7 Automatic Selection Range Upper Limit	1000		
Input indication range upper limit	1320		





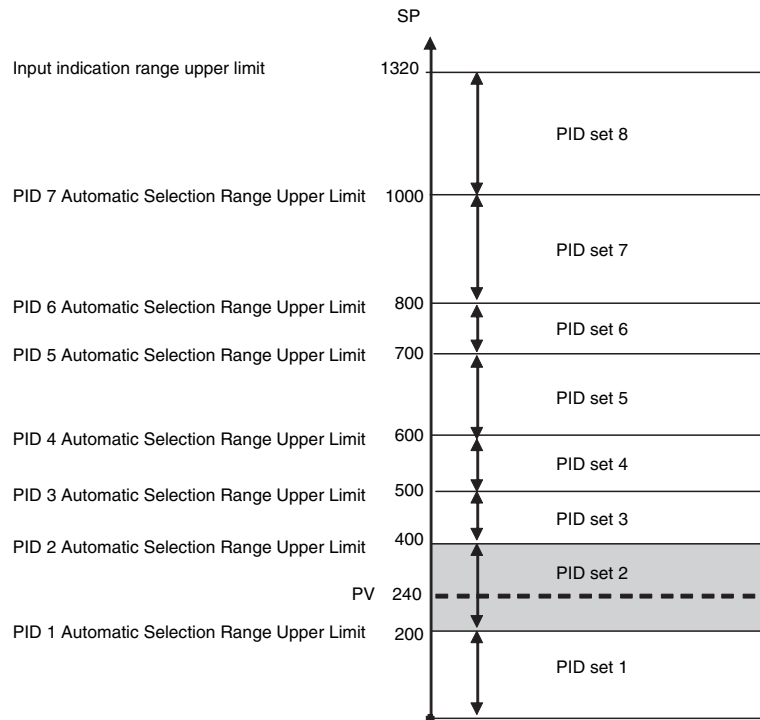

- Set the PID Set No. parameter for program 0 to 0 (automatic selection).
- Set the PID Set Automatic Selection Data parameter to PV (process value).
- Set the upper limit of each zone as the automatic selection range upper limit for each PID set.

In the following example (PID Set Automatic Selection Data = PV), PID set 2 is automatically selected when the PV is 240°C.





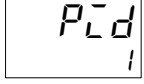

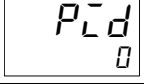
## Operating Procedure



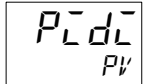



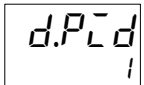

## ● Setting Automatic Selection of PID Sets (Program Setting Level)

<b>1</b> Move to the Program Setting Level. The Display Program Selection parameter is displayed.	Program Setting Level  Display Program Selection
<b>2</b> Press the  or  Key to select 0. The default is the currently selected program number.	
<b>3</b> Press the  Key several times to display the PID Set No. parameter.	Program Setting Level  PID Set No.
<b>4</b> Press the  or  Key to select 0 (automatic selection). The default is 1.	

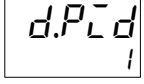
## ● Setting the PID Set Automatic Selection Data (Advanced Function Setting Level)

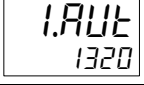
<b>1</b> Press the  Key several times in the Advanced Function Setting Level to display the PID Set Automatic Selection Data parameter.	Advanced Function Setting Level  PID Set Automatic Selection Data
<b>2</b> Press the  or  Key to select PV (process value). The PID set for the zone with the process value will be enabled. The default is the process value.	

## ● Setting the Upper Limits of the Zones (PID Setting Level)

<b>1</b> Move to the PID Setting Level. The Display PID Selection parameter is displayed.	PID Setting Level  Display PID Selection
<b>2</b> Press the  or  Key to select 1. The default is the currently selected PID set.	 Display PID Selection
<b>3</b> Press the  Key several times to select the PID 1 Set Automatic Selection Range Upper Limit parameter.	PID Setting Level  PID 1 Automatic Selection Range Upper Limit
<b>4</b> Press the  or  Key to set 200. Return to step 1 and set the zone upper limits for PID sets 2 to 7. The setting for PID set 8 is always the upper limit of the input indication range.	

### 5-13-3 Setting PID Set Parameters

This section provides the procedures to set PID-related parameters manually.









\* You do not need to set these parameters manually if you set them automatically with AT (autotuning).

#### Setting Example

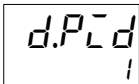
In this example, the PID 1 Proportional Band parameter (for PID set 1) is set to 20.0.

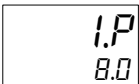
#### Operating Procedure

##### ● Setting the PID 1 Proportional Band (PID Setting Level)

<p><b>1</b> Move to the PID Setting Level. The Display PID Selection parameter is displayed.</p>	<p>PID Setting Level</p>  <p>Display PID Selection</p>
<p><b>2</b> Press the  or  Key to select 1 (PID set 1). The default is the currently selected PID set.</p>	
<p><b>3</b> Press the  Key to display the PID 1 Proportional Band parameter.</p>	<p>PID Setting Level</p>  <p>PID 1 Proportional Band</p>
<p><b>4</b> Press the  or  Key to set 20.0. The default is 8.0. Continue by pressing the  Key to display the other parameters for PID set 1. Change the settings of the parameters as necessary.</p>	



# 5-14 Determining PID Constants for PID Sets (Autotuning for All PID Sets)

## 5-14-1 Autotuning All PID Sets (Autotuning)

### Introduction

You can perform autotuning for all PID sets at the same time to automatically calculate and set the PID constants for the PID sets in the order of the set numbers. This greatly reduces the number of operations required to adjust control characteristics.

You can use this function only when you use automatic selection of PID sets according to temperature zones with fixed SP operation.

#### ● The PID Sets and SPs to Which Autotuning for All PID Sets Applies

Autotuning PID sets is applied to all PID sets from the starting point to the ending point.

PID sets for which autotuning applies		SP for autotuning the PID set
Starting point (lower limit)	The PID set for the zone that contains the fixed SP (FSP)	Fixed SP (FSP) (Adjustment Level)
Intermediate points	PID sets $n$ ( $n = 2$ to $7$ ) that are between the PID sets for the starting and ending points	Mean value of the PID $n$ upper limit and PID set $n-1$ upper limit Example: The SP for PID set 3 is the mean value of the upper limit of PID set 3 and the upper limit of PID set 2.
Ending point (upper limit)	The PID set for the zone that contains the All PID AT Upper Limit SP	All PID AT Upper Limit SP (Initial Setting Level)

Example: The following example is for when the zone for PID set 1 contains the fixed SP (FSP) and the zone for PID set 8 contains the All PID AT Upper Limit SP.

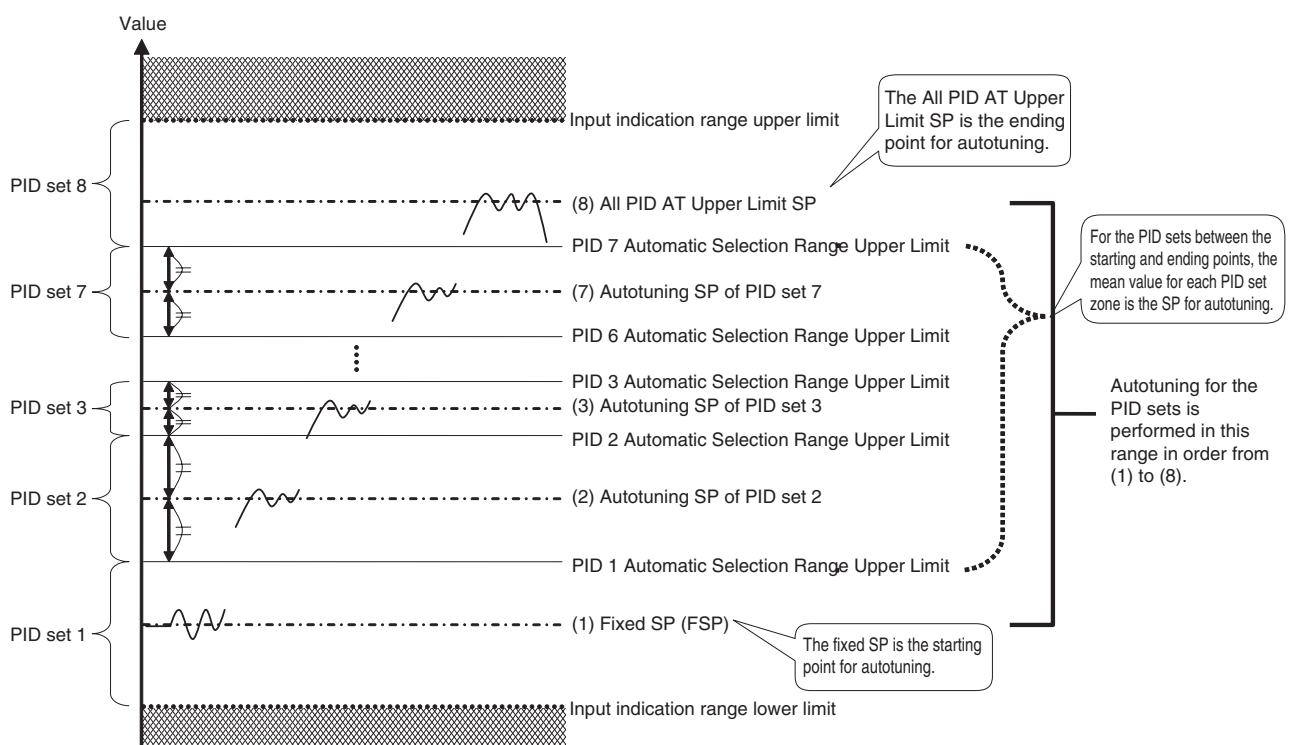

## ● Related Parameters

Parameter	Display	Setting range	Default	Restrictions for autotuning all PID sets	Level
SP Mode	<i>SPMd</i>	<i>PSP</i> : Program SP <i>FSP</i> : Fixed SP	PSP	Must be set to a fixed SP.	Adjustment Level
AT Execute/Cancel	<i>At</i>	<i>AtR1</i> : All PID 40% AT <sup>*1*2</sup> <i>AtR2</i> : All PID 100% AT <sup>*1</sup> <i>OFF</i> : AT cancel <i>At-1</i> : 100% AT <i>At-2</i> : 40% AT <sup>*2</sup>	AT Cancel	Must be set to All PID 40% AT or All PID 100% AT.	
Fixed SP	<i>FSP</i>	SP lower limit to SP upper limit	0	Must be set in the zone of the PID set that is the autotuning starting point.	
Reset Operation	<i>AtSM</i>	<i>Stop</i> : Stop control <i>FSP</i> : Fixed SP operation	STOP	---	
All PID AT Upper Limit SP	<i>AtSPU</i>	SP lower limit to SP upper limit	0	Must be set in the zone of the PID set for the autotuning ending point.	Initial Setting Level
PID Set No.	<i>Pd</i>	<i>DV</i> : Automatic selection <i>1</i> to <i>8</i> : PID set 1 to 8	PID Set 1	Must be set to 0.	Program Setting Level
PID 1 to 7 Automatic Selection Range Upper Limits <sup>*3</sup>	<i>AtUL</i>	Temperature: -1,999 to 9,999 EU	1320	Must be set to the upper limits of the automatic PID set number selection zones for autotuning.	PID Setting Level
		Analog: -5.0 to 105.0%	105.0		
PID Set Automatic Selection Data	<i>PdL</i>	<i>PV</i> : PV <i>dV</i> : Deviation (PV - SP) <i>SP</i> : SP	PV	Must be set to PV or SP.	Advanced Function Setting Level
PID Set Automatic Selection Hysteresis	<i>PdH</i>	0.10 to 99.99 %FS	0.50	---	

\*1 These settings are not displayed if the PID Set Automatic Selection Data parameter is set to DV or the PID Set No. parameter is not set to 0 (automatic selection).

\*2 These settings are not displayed for heating/cooling control or floating position-proportional control.

\*3 You cannot set the PID 8 Automatic Selection Range Upper Limit parameter. It will be the upper limit of the input indication range.

- Autotuning is not performed for PID sets that have the default settings.
- If all PID sets have the default settings, 100% AT or 40% AT is performed.

## Execution Conditions

All of the following conditions must be met to perform autotuning for all PID sets.

- The must be no input errors.
- The PID ON/OFF parameter must be set to PID or a position-proportional model must be used.
- The Auto/Manual parameter must be set to automatic.
- The PID Set Automatic Selection Data must be set to PV or SP. (Do not set it to DV.)
- The PID Set No. parameter for the program to autotune must be set to 0 (automatic selection) and at least one of the PID 1 to 7 Automatic Selection Range Upper Limits must be changed from the default setting.

## Description

### ● Operation

When you autotune all PID sets, the PID sets are autotuned in order of the PID set numbers with the fixed SP (FSP) as the lower limit (starting point) and the All PID AT Upper Limit SP as the upper limit (ending point). (Ascending order is used for reverse operation and descending order is used for direct operation.)

The Fixed SP parameter is overwritten while autotuning for all PID sets is executed. If you cancel autotuning before it is completed, the current SP will remain as the value of the Fixed SP parameter. If autotuning for all PID sets is completed normally, the setting of the Fixed SP parameter is returned to the lower limit (starting point).

Example: The following example is for when the zone for PID set 2 contains the fixed SP (FSP) (starting point) and the zone for PID set 7 contains the All PID AT Upper Limit SP (ending point).

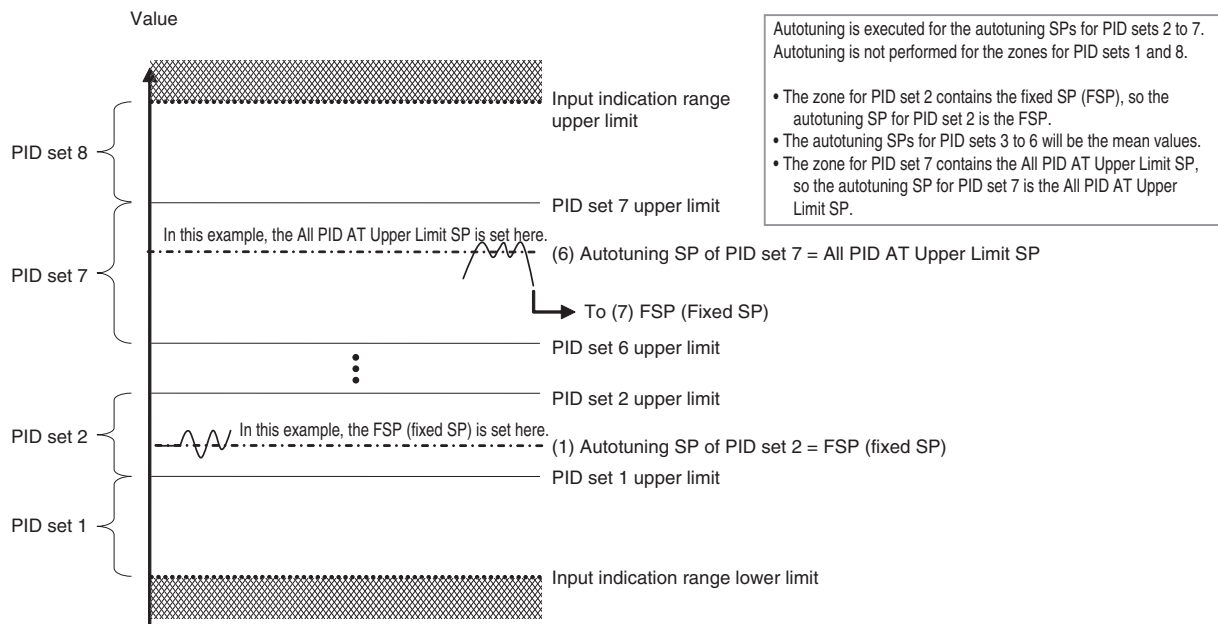

### Precautions for Correct Use

If any of the starting point (fixed SP (FSP)), mean values of the starting and ending points for the PID set automatic selection zone upper limits, and the ending point (All PID AT Upper Limit SP) are in the zone for the same PID set, the following order of priority is used for the autotuning SP.

Fixed SP (FSP) > All PID AT Upper Limit SP > Mean value of PID set upper limits

Example: If both the fixed SP (FSP) and the All PID AT Upper Limit SP are in the zone for PID set 2, the fixed SP (FSP) is the SP for autotuning PID set 2.

● **Operation Waveform Example**

The waveform for autotuning all PID sets is shown below for when the zone for PID set 1 contains the fixed SP (FSP) and the zone for PID set 8 contains the All PID AT Upper Limit SP.

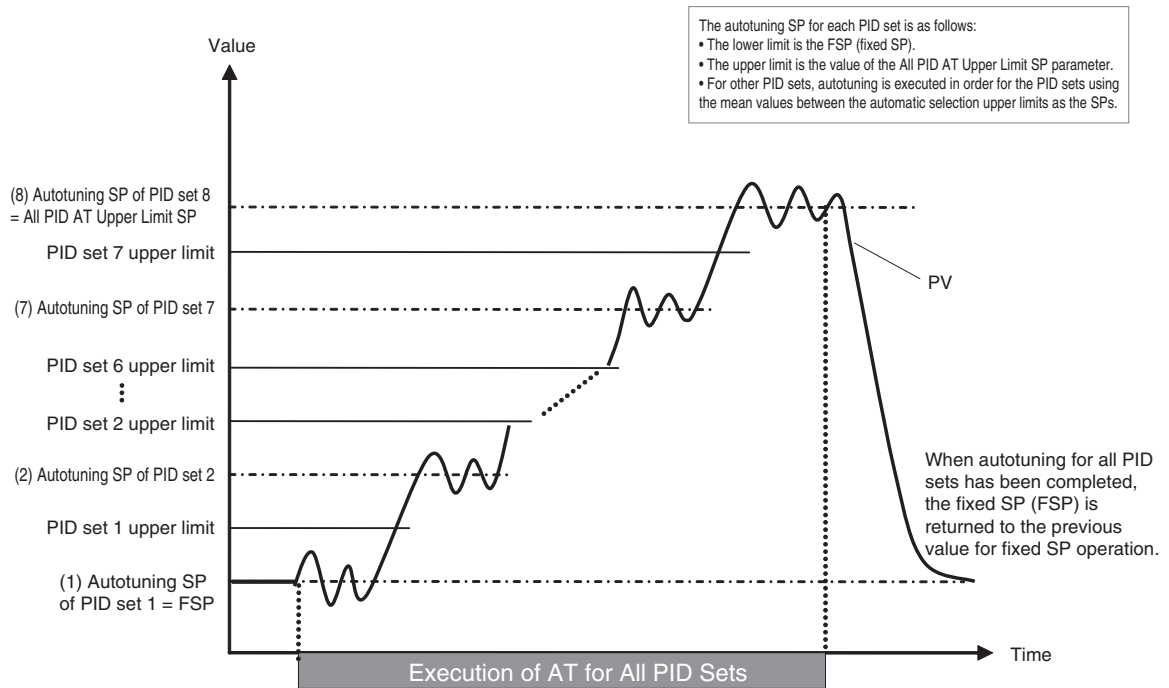

**5-14-2 Executing Autotuning for All PID Sets**

This example provides the procedure to execute 100% autotuning for all of four PID sets.

**Operating Flow**

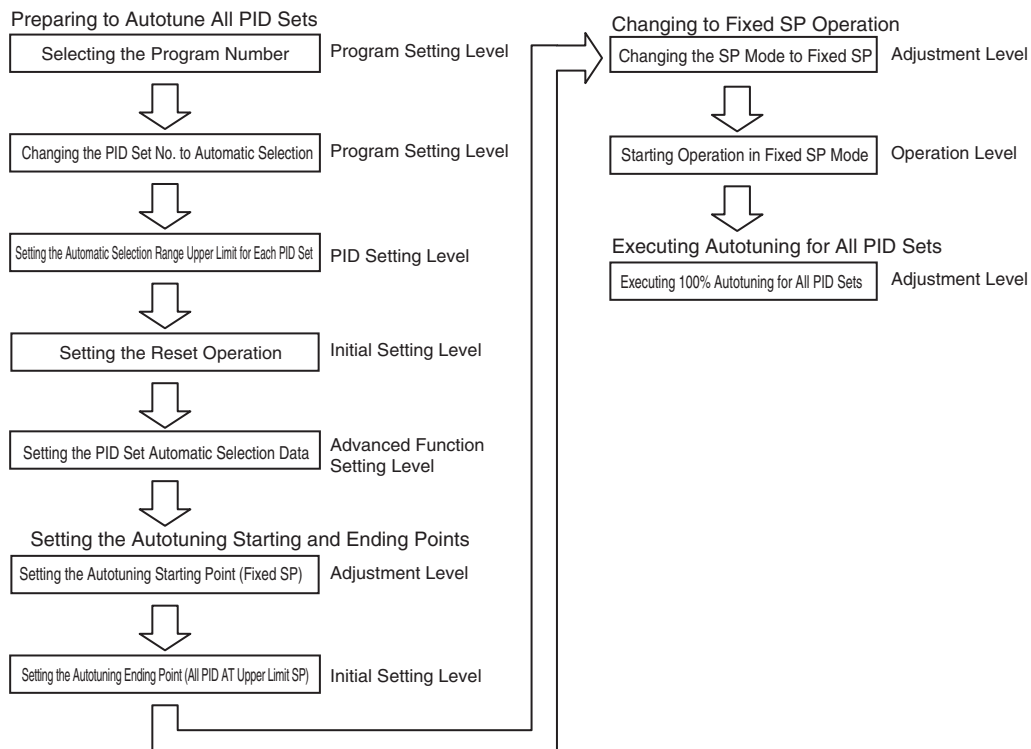



### Conditions

- Reset Operation = Stop control
- PID Set Automatic Selection Data = PV
- Program No. 0 = 0
- PID Set No = 0 (Auto selection)
- PID 1 Automatic Selection Range Upper Limit = 200 (Range for PID set 1: Fixed SP to 200)
- PID 2 Automatic Selection Range Upper Limit = 400 (Range for PID set 2: 200 to 400)
- PID 3 Automatic Selection Range Upper Limit = 500 (Range for PID set 3: 400 to 500)
- PID 4 Automatic Selection Range Upper Limit = 1,320 (Range for PID set 4: 500 to All PID AT Upper Limit SP)
- Fixed SP = 100
- All PID AT Upper Limit SP = 600



### Operating Procedure

#### Preparing for Autotuning All PID Sets

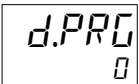
##### ● Selecting the Program Number (Program Setting Level)

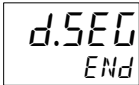

<p><b>1</b> Select the Display Program Selection parameter in Program Setting Level.</p>	<p>Program Setting Level</p>  <p>Display Program Selection</p>
<p><b>2</b> Press the  or  Key to set 0 (program 0). The default is 0.</p>	

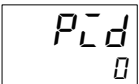
##### ● Setting Automatic Selection of PID Sets (Program Setting Level)

<p><b>1</b> After the above procedure, press the  Key several times to select the PID Set No. parameter.</p>	<p>Program Setting Level</p>  <p>Display Segment Selection</p>
<p><b>2</b> Press the  or  Key to set 0 (automatic selection). The default is 1.</p>	

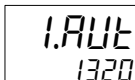

Refer to 4-1-2 Moving to the Program Setting Level for the procedure to enter the Program Setting Level.

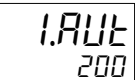
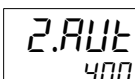
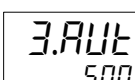
● **Setting the Upper Limits of the Zones for the PID Sets (PID Setting Level)**

<p><b>1</b> Press the  Key several times in the PID Setting Level to select the PID 1 Automatic Selection Range Upper Limit parameter.</p>	<p>PID Setting Level</p>  <p>PID 1 Automatic Selection Range Upper Limit</p>
<p><b>2</b> Press the  or  Key to set 200. The default is the input indication range upper limit.</p>	
<p><b>3</b> Also set the PID 2 and 3 Automatic Selection Range Upper Limit parameters in the same way. * You cannot set the PID 4 Automatic Selection Range Upper Limit parameter.</p>	<p>PID Setting Level</p>  <p>PID 2 Automatic Selection Range Upper Limit</p> <p>PID Setting Level</p>  <p>PID 3 Automatic Selection Range Upper Limit</p>

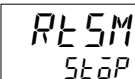

Refer to 4-1-4 Moving to the PID Setting Level for the procedure to enter the PID Setting Level.

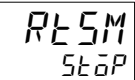
● **Setting the Reset Operation (Initial Setting Level)**

<p><b>1</b> Press the  Key several times in the Initial Setting Level to select the Reset Operation parameter.</p>	<p>Initial Setting Level</p>  <p>Reset Operation</p>
<p><b>2</b> Press the  or  Key to set StOP (stop control). The default is StOP (stop control).</p>	

Refer to 4-1-1 Moving to the Initial Setting Level for the procedure to enter the Initial Setting Level.

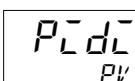

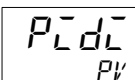
● **Setting the PID Set Automatic Selection Data (Advanced Function Setting Level)**

<p><b>1</b> Press the  Key several times in the Advanced Function Setting Level to select the PID Set Automatic Selection Data parameter.</p>	<p>Advanced Function Setting Level</p>  <p>PID Set Automatic Selection Data</p>
<p><b>2</b> Press the  or  Key to set PV (process value). The default is PV (process value).</p>	

Refer to 4-1-6 Moving to the Advanced Function Setting Level for the procedure to enter the Advanced Function Setting Level.

## Setting the Autotuning Starting and Ending Points

### ● Setting the Autotuning Starting Point (Fixed SP) (Adjustment Level)

<b>1</b> Press the  Key several times in the Adjustment Level to select the Fixed SP parameter.	Adjustment Level  Fixed SP
<b>2</b> Press the  or  Key to set 100. The default is 0.	

Refer to 4-1-1 Moving to the Initial Setting Level for the procedure to enter the Adjustment Level.

### ● Setting the Autotuning Ending Point (All PID AT Upper Limit SP) (Initial Setting Level)

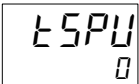
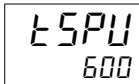
<b>1</b> Press the  Key several times in the Initial Setting Level to display the All PID AT Upper Limit SP parameter.	Initial Setting Level  All PID AT Upper Limit SP
<b>2</b> Press the  or  Key to set 600. The default is 0.	

Refer to 4-1-1 Moving to the Initial Setting Level for the procedure to enter the Initial Setting Level.

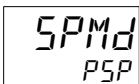
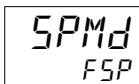

## Changing to Fixed SP Operation

### ● Changing the SP Mode to Fixed SP (Adjustment Level) (The Reset Operation parameter must be set to stop control.)

<b>1</b> Press the  Key several times in the Adjustment Level to select the SP Mode parameter.	Adjustment Level  SP Mode
<b>2</b> Press the  or  Key to set F5P (fixed SP). The default is P5P (program SP).	



Refer to 4-1-1 Moving to the Initial Setting Level for the procedure to enter the Adjustment Level.

● **Starting Operation in Fixed SP Mode (Operation Level)**  
 (The Reset Operation parameter must be set to stop control.)

<p><b>1</b> Press the  Key several times in the Operation Level to display the Run/Reset parameter</p>	<p>Operation Level</p> <div style="border: 1px solid black; padding: 5px; display: inline-block;"> <p style="margin: 0;">R-R RSt</p> </div> <p style="margin-left: 10px;">Run/Reset</p>
<p><b>2</b> Press the  or  Key to set RUN.                  The default is RSt (reset).                  *Fixed SP operation is started.</p>	<div style="border: 1px solid black; padding: 5px; display: inline-block;"> <p style="margin: 0;">R-R RUN</p> </div>

## Executing Autotuning for All PID Sets

● **Executing 100% Autotuning for All PID Sets (Adjustment Level)**

<p><b>1</b> Press the  Key several times in the Adjustment Level to select AT Execute/Cancel.</p>	<p>Adjustment Level</p> <div style="border: 1px solid black; padding: 5px; display: inline-block;"> <p style="margin: 0;">AT aFF</p> </div> <p style="margin-left: 10px;">AT Execute/Cancel</p>
<p><b>2</b> Press the  or  Key to select AT All (All PID 100% AT Execute/Cancel).                  The default is aFF.                  *Autotuning is executed for all of the PID sets.</p>	<div style="border: 1px solid black; padding: 5px; display: inline-block;"> <p style="margin: 0;">AT AT All</p> </div>

Refer to 4-1-1 Moving to the Initial Setting Level for the procedure to enter the Adjustment Level.



### Precautions for Correct Use

Canceling and Restarting Autotuning for All PID Sets

- Because autotuning is performed for all of the PID sets, time may be required to complete autotuning.
- To cancel autotuning for all PID sets, set the AT Execute/Cancel parameter to AT cancel. When you do, the PID constants of the PID sets for which autotuning has been completed will be saved.
- To restart autotuning for all PID sets, set the fixed SP (FSP) in the zone for the PID set number that was being autotuned when autotuning was canceled. Then execute autotuning for all PID sets again. This will cause autotuning for all PID sets to start again from the PID set where it was canceled.



## 5-15 Program-related Functions

This section describes the following program-related functions.

- Advance
- Segment Jump
- Hold
- Wait
- Program Repetition
- Program Links
- SP Shift
- Time Signals
- Program End Outputs
- RUN Output
- Stage Outputs
- PV Start
- Standby Operation
- SP Mode Switch
- SP Tracking
- Changing Programs during Operation
- Operations Related to Other Functions

### 5-15-1 Advance

The advance operation moves the program to the start of the next segment.

- An advance operation moves the program forward to the end of the present segment each time the Advance parameter is set to ON. The Advance parameter turns OFF after the next segment has been reached.

Note 1 This function cannot be performed with a key operation. Use a segment jump (segment number) for a key operation.

- 2 The advance operation cannot be executed at the following times:

During reset status, during standby status, during autotuning, and when the Operation End Operation parameter is set to Continue.

#### ● Related Parameters

##### Advancing with an Event Input

Parameter name	Display	Setting range	Default	Level
Event Input Assignment	<i>EV-1</i> <i>EV-2</i> <i>EV-3</i> <i>EV-4</i> <i>EV-5</i> <i>EV-6</i>	<i>RdV</i> : Advance	Event Input Assignment 1: <i>RR-1</i> Event Input Assignment 2: <i>RdV</i> Event Input Assignment 3 to 6: <i>NONE</i>	Initial Setting Level

### 5-15-2 Segment Jump

You can force a jump to a specified segment.

- This function can be performed only with a key operation.
- When you change the Segment No. parameter (Operation Level), operation will jump to the start of the specified segment.

Note: The segment jump operation cannot be executed at the following times:

During reset status, during standby status, during autotuning, and when the Operation End Operation parameter is set to Continue.

#### ● Related Parameters

Parameter name	Display	Setting range	Default	Level
Segment Number	5EE	Specify the segment number. 0 to Number of segments used – 1		Operation Level

### 5-15-3 Hold

You can force program execution to pause.

- Timing is stopped when the Hold parameter (Operation Level) is set to ON and restarted when the Hold parameter is set to OFF.
- The hold status is canceled at the following times:  
When the Hold parameter (Operation Level) is set to OFF (hold cancel), when the Run/Reset parameter is set to Run or Reset, or when program operation is completed for an advance operation
- If an advance operation is executed during a hold, the hold is continued from the beginning of the next segment.
- During hold status, *HOLD* will alternate with the normal value on the No. 2 display if the PV is displayed on the No. 1 display. The alternating display will stop when the hold status is cleared.

Normal Status                      Hold Status

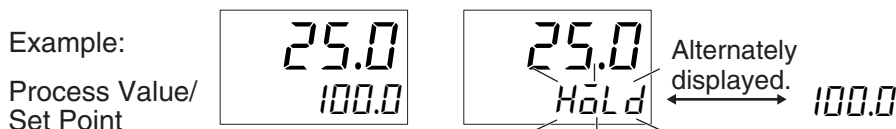

Note: The hold operation cannot be executed at the following times:

During reset status, during standby status, during autotuning, and when the Operation End Operation parameter is set to Continue.



#### Additional Information

##### Priority of Flashing and Alternating Displays on No. 2 Display

The priority of flashing displays and alternating displays is as follows:

1. Alternating displays during SV status display
2. Alternating displays/hold display during program end output

## ● Related Parameters

### Pausing Program Operation with a Key Operation

Parameter name	Display	Setting range	Default	Level
Hold	<i>HōLd</i>	<i>ōN</i> : Hold <i>ōFF</i> : Hold clear	<i>ōFF</i>	Operation Level

### Pausing Program Execution with an Event Input

Parameter name	Display	Setting range	Default	Level
Event Input Assignment	<i>EV-1</i> <i>EV-2</i> <i>EV-3</i> <i>EV-4</i> <i>EV-5</i> <i>EV-6</i>	<i>HLd1</i> : Hold/Clear Hold <i>HLd2</i> : Hold	Event Input Assignment 1: <i>RR-1</i> Event Input Assignment 2: <i>RdV</i> Event Input Assignment 3 to 6: <i>NōNE</i>	Initial Setting Level

### Pausing Program Operation with the PF Key

Parameter name	Display	Setting range	Default	Level
PF Setting	<i>PF</i>	<i>HōLd</i> : Reverse Hold/Clear Hold	<i>SHFL</i>	Advanced Function Setting Level

#### 5-15-4 Wait

You can prevent execution from moving to the next segment at the end of a segment if the difference between the PV and the present set point (PSP) is not within a preset range. Use this operation to restrict the PV as a condition for moving to the next segment.

- The preset range is called the wait band. Set the wait band in the Wait Band parameter (Adjustment Level). The wait operation is not performed if the wait band is set to OFF.
- As soon as the deviation enters the wait band, the program moves to the next segment.

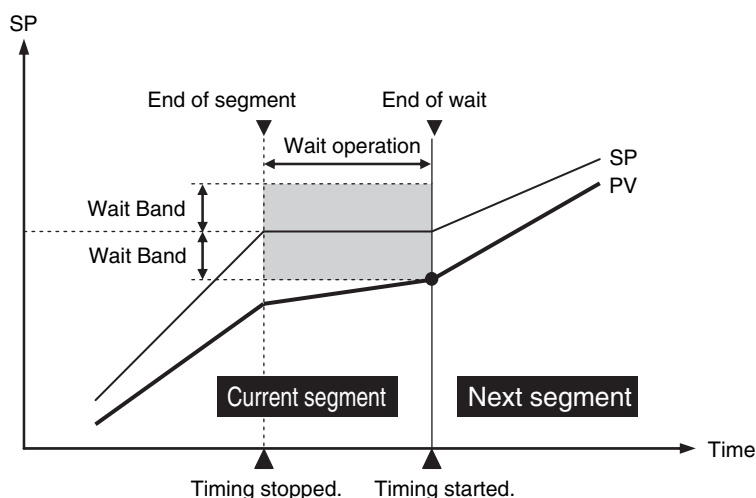

Note The wait operation is not performed if it is disabled by an event input.

## ● Related Parameters

### Enabling Waiting and Setting a Wait Band

Parameter name	Display	Setting range	Default	Level
Wait Band	<i>Wt-b</i>	Temperature input: 0.1 to 999.9°C or °F, Analog input: 0.01 to 99.99	<i>OFF</i>	Adjustment Level

### Enabling and Disabling Waiting with an Event Input

Parameter name	Display	Setting range	Default	Level
Event Input Assignment	<i>EV-1</i> <i>EV-2</i> <i>EV-3</i> <i>EV-4</i> <i>EV-5</i> <i>EV-6</i>	<i>WRLE</i> : Wait Enable/Disable	Event Input Assignment 1: <i>RR-1</i> Event Input Assignment 2: <i>RdV</i> Event Input Assignment 3 to 6: <i>NONE</i>	Initial Setting Level

## 5-15-5 Program Repetition

You can repeatedly execute the same program.

- Setting program repetitions automatically restarts execution of the same program from segment 0 after the final segment is executed. You can set the number of program repetition to up to 9,999 repetitions. Set the number of program repetitions in the Program Repetitions parameter (Program Setting Level).
- The number of executions will be one more than the specified number of program repetitions.
- If the Program Repetitions parameter is changed to a smaller number during program operation, the currently executing program will be executed to the end and then the program will stop.

## ● Related Parameters

Parameter name	Display	Setting range	Default	Level
Program Repetitions	<i>RPL</i>	0 to 9999	0	Program Setting Level

## 5-15-6 Program Links

You can specify the number of the next program to execute when execution of a program is completed.

- When the last segment is executed, execution will move to segment 0 of the program specified in the Program Link Destination parameter (Program Setting Level). Operation will be ended if the Program Link Destination parameter is set to END.
- If a program repeat operation is also set, the program link will start after the program repetition operation has been completed.
- If the current program number is specified in the Program Link Destination parameter, the program will be repeated indefinitely.
- After all programs have been executed, operation will be according to the setting for the Operation End Operation parameter.

## ● Related Parameters

Parameter name	Display	Setting range	Default	Level
Program Link Destination	<i>LINK</i>	<i>END</i> , 0 to 7	<i>END</i>	Program Setting Level

### 5-15-7 SP Shift

You can shift the program patterns vertically. The shift is applied to all of the programs.

- The program SP is shifted by the amount set in the Program SP Shift Value parameter (Adjustment Level).

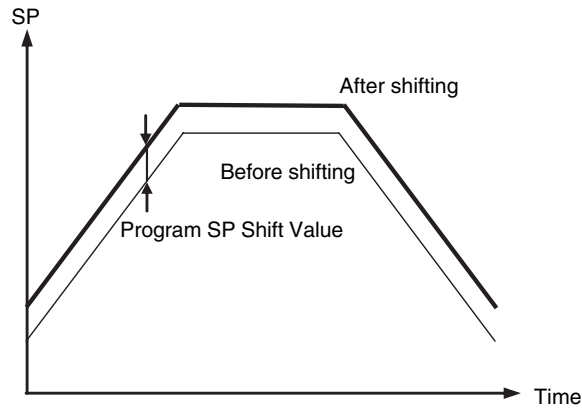

#### ● Related Parameters

Parameter name	Display	Setting range	Default	Level
Program SP Shift Value	PSP5	-1999 to 9999	0	Adjustment Level

### 5-15-8 Time Signals

You can set an output that turns ON after the ON time has elapsed from the start of the specified segment and then turns OFF after the OFF time has elapsed from the start of the specified segment.

- You can assign this function to either an auxiliary output or a control output.
- You can set two different time signals for each program.

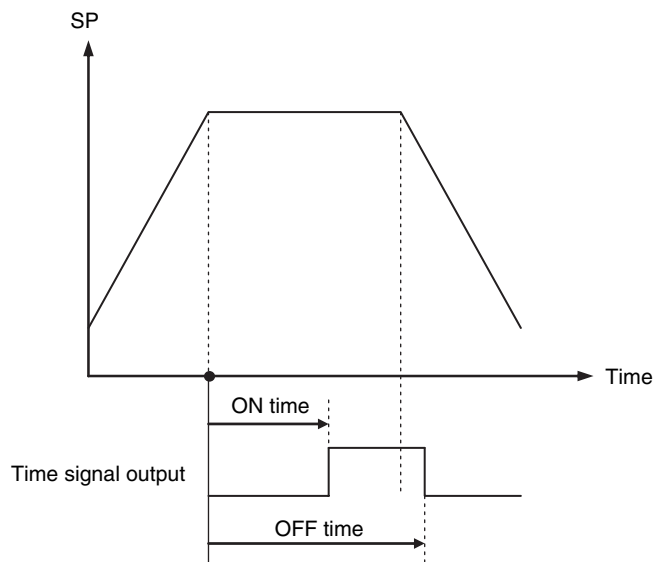

- Set the segments for which the time signals are to be started in the Time Signal 1 and 2 Set Segment parameters (t515 and t525) (Program Setting Level). The default is 0.
- Set the ON/OFF timing in the Time Signal 1 and 2 ON Time parameters (oN1 and oN2) and Time Signal 1 and 2 OFF Time parameters (oF1 and oF2) (Program Setting Level). The default is 0.00.
- ON Conditions
  - If the OFF time is shorter than the ON time, the output remains ON from when the ON time has elapsed until the next OFF condition.

- If an advance operation is executed, a time equivalent to the set program time will be considered to have elapsed. For example, if an advance operation is executed before the ON time elapses in the above figure, the output remains ON from the start of the next segment until the OFF time has elapsed.
- The time signals will turn OFF at the following times.
  - During a reset
  - If one program execution has been completed when program repetitions or a program link has been set
  - If the Operation End Operation parameter is set to Fixed SP Mode and the program ends
  - When the ON time and the OFF time are the same
- The time signal timer stops during hold, wait, and autotuning operations.

● **Related Parameters**

Parameter name	Display	Setting range	Default	Level
Time Signal 1 and 2 Set Segment	tS1S tS2S	0 to 31 (number of segment for time signal)	0	Program Setting Level
Time Signal 1 and 2 ON Time	aN1 aN2	0.00 to 99.99, Hours.minutes or minutes.seconds	0.00	Program Setting Level
Time Signal 1 and 2 OFF Time	aF1 aF2	0.00 to 99.99, Hours and minutes, or minutes and seconds	0.00	Program Setting Level
Auxiliary Output 1 to 4 Assignment or Control Output 1 to 2 Assignment	SUb1 SUb2 SUb3 SUb4 aUt1 aUt2	tS1 or tS2	Auxiliary Output 1 Assignment: ALM1* Auxiliary Output 2 Assignment: ALM2* Auxiliary Output 3 Assignment: ALM3* Auxiliary Output 4 Assignment: ALM4* Control Output 1 Assignment: a* Control Output 2 Assignment: NONE*	Advanced Function Setting Level

\* Refer to 6-10 Advanced Function Setting Level for details on assigning auxiliary outputs and control outputs.

### 5-15-9 Program end outputs

You can set an output to turn ON when a program ends (i.e., at the end of the last segment) and then turn OFF after a specified time.

- You can assign this function to either an auxiliary output or a control output. If you do not assign this function, no output is made and only *P.END* and the SP are displayed alternately.

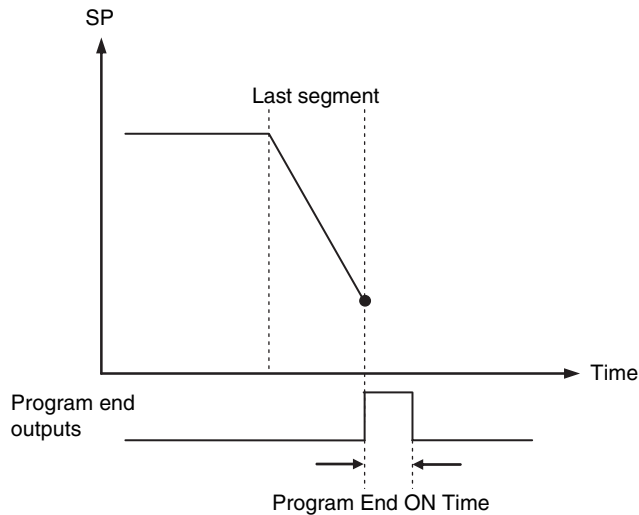

- The program end output occurs at the end of the last segment of the last program execution if program repetitions or a program link is set.
- The pulse width of the program end output is set using the Program End ON Time parameter. The setting range for the Program End ON Time parameter is 0.0 to 10.0 s. The default is 0.0.
- If the Program End Output Time parameter is set to ON, the output will remain ON until the Run/Reset parameter is changed to Run. If the Operation End Operation parameter is set to Reset and the power is reset or you move from the Initial Setting Level to the Operation Level while the program end output is ON, the program end output will turn OFF.
- The program end output is turned OFF if the Run/Reset parameter is changed to Run. If the Operation End Operation parameter is set to Fixed SP Control and the SP Mode is changed to Program SP Mode after the end of program operation, the program end output will turn OFF.
- If the power supply is turned OFF, a software reset is performed with a operation command via communications, or you change from a level where control is executed to a level where control is stopped while the program end output is ON, the program end output will turn OFF.
- Display at the Program End

When the program ends, the process value will be displayed on the No. 1 display\* and the set point and *P.END* will be alternately displayed on the No. 2 display at 1-s intervals.

\* The PV is displayed for the following settings: PV/SP, PV only, or PV/MV.

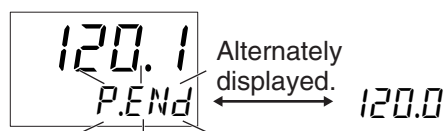

● Related Parameters

Parameter name	Display	Setting range	Default	Level
Auxiliary Output 1 to 4 Assignment or Control Output 1 to 2 Assignment	SUB1 SUB2 SUB3 SUB4 OUT1 OUT2	PEND: Program end output	Auxiliary Output 1 Assignment: RLM1* Auxiliary Output 2 Assignment: RLM2* Auxiliary Output 3 Assignment: RLM3* Auxiliary Output 4 Assignment: RLM4* Control Output 1 Assignment: $\bar{a}$ * Control Output 2 Assignment: NONE*	Advanced Function Setting Level
Program End ON Time	PEND	$\bar{a}N$ : Output continuously. 0.0: No output. 0.1 to 10.0	0.0	

**5-15-10 RUN Output**

You can set an output to turn ON in run status and OFF in reset status.

- You can assign this function to either an auxiliary output or a control output.

● Related Parameters

Parameter name	Display	Setting range	Default	Level
Auxiliary Output 1 to 4 Assignment or Control Output 1 to 2 Assignment	SUB1 SUB2 SUB3 SUB4 OUT1 OUT2	RUN: RUN Output	Auxiliary Output 1 Assignment: RLM1* Auxiliary Output 2 Assignment: RLM2* Auxiliary Output 3 Assignment: RLM3* Auxiliary Output 4 Assignment: RLM4* Control Output 1 Assignment: $\bar{a}$ * Control Output 2 Assignment: NONE*	Advanced Function Setting Level

Note: Refer to 6-10 Advanced Function Setting Level for details on assigning auxiliary outputs and control outputs.



### 5-15-11 Stage Outputs

A pulse is output for one second from the beginning of each segment.

- You can assign this function to either an auxiliary output or a control output.

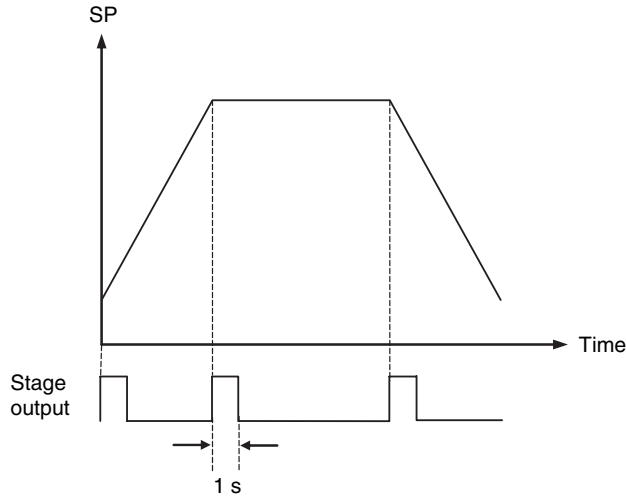

Note If the power supply is turned OFF, a software reset is performed with an operation command through communications, or the Initial Setting Level is entered while the stage output is ON, the stage output will turn OFF.

#### ● Related Parameters

Parameter name	Display	Setting range	Default	Level
Auxiliary Output 1 to 4 Assignment or Control Output 1 to 2 Assignment	5061 5062 5063 5064 0001 0002	500: Stage output	Auxiliary Output 1 Assignment: ALM1* Auxiliary Output 2 Assignment: ALM2* Auxiliary Output 3 Assignment: ALM3* Auxiliary Output 4 Assignment: ALM4* Control Output 1 Assignment: 0* Control Output 2 Assignment: NONE*	Advanced Function Setting Level

### 5-15-12 PV Start

With the PV start operation, program operation starts at the first SP in the program pattern that matches the PV (i.e., in the middle of the program).

For example, if you reset program operation and want to restart immediately from the middle of the program, you can use this operation to save time in comparison with starting operation from the beginning of the program.

- To use the PV start operation, set the PV Start parameter (Initial Setting Level) to a PV start. However, if the Reset Operation parameter is set to stop control and step time programming is set,

only the SP start option can be set (because in this case program operation will always start from the process value (PV)).

- Set the PV Start parameter (Initial Setting Level) to one of the following settings.
  - SP Start (Default)
    - Program operation is started from the beginning.
    - However, the set point when program operation starts is as follows:

	Reset Operation	
	Stop control	Fixed SP operation
Step time programming	Segment 0 SP	Fixed SP
Rate of rise programming	Process value (PV)	

- PV Start
  - Program operation starts at the first SP that matches the PV from the start of operation (i.e., from the middle of the program).
  - If the PV does not match any SP in the program, operation starts at the beginning of the program.

An example of the operation when the PV Start parameter (Initial Setting Level) is set to a PV start is given below.

Example: The first position where the PV and the SP match is in segment 3. From there, the program is indicated by a bold line. The program segments prior to that position are ignored.

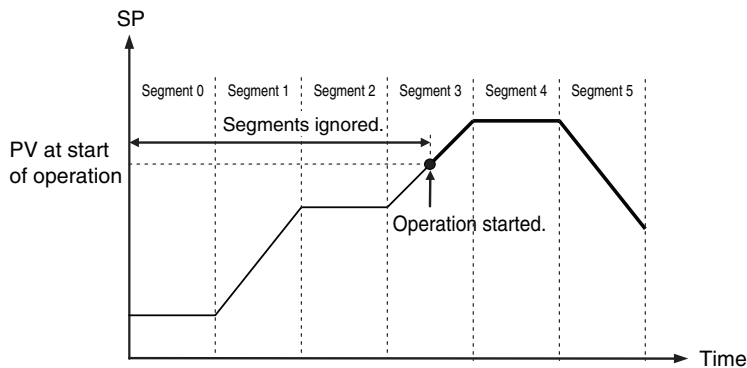



### Precautions for Correct Use

If the reset operation is fixed SP control, rate of rise programming is set, and segment 0 is a step segment, the program pattern includes everything from the fixed SP (the SP for starting program operation) to the SP for segment 0 (step segment).

Therefore, a PV start is not performed if the PV at the start of operation is between the fixed SP and the SP for the segment 0 step segment, as shown in the following diagram. Program operation will start from the SP of the segment 0 step segment.

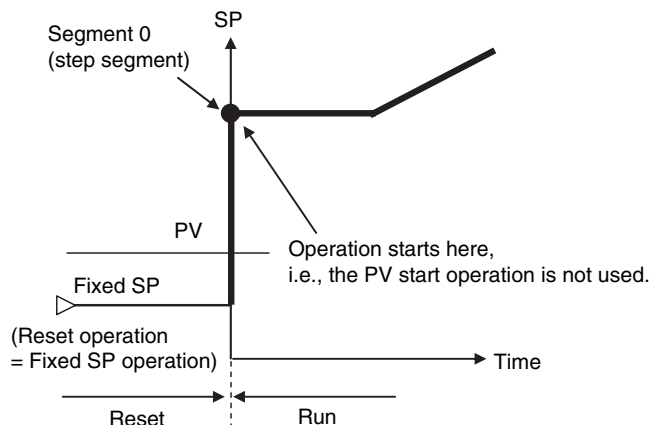

### Additional Information

- For the PV start operation, operation starts from the first point in the middle of the program when the SP and PV are equal. If you want to start from the PV when starting segment 0, do not use the PV start operation. Rather, set the program setting method to rate of rise programming and set the reset operation to stop control.
- If program repetitions or program links are set, the PV Start operates only for the first program execution.

### ● Related Parameters

Parameter name	Display	Setting range	Default	Level
PV Start	$PV \leq SP$	$PV$ : PV Start $SP$ : SP Start	$SP$	Initial Setting Level

## 5-15-13 Standby Operation

You can delay the start of program operation.

- If the standby operation is set, the program does not start until the time set for the Standby Time parameter ( $S_{tb}$ ) (hours and minutes, or days and hours) has elapsed after changing from reset status to run status.
- The following conditions apply to operation during standby status:
  - The indicators and status displays will show run status.
  - If the Reset Operation parameter is set to stop control, the MV at reset will be output from the control output. If the Reset Operation parameter is set to fixed SP operation, the fixed SP will be output.
  - Hold, advance, and autotuning operations cannot be used if the Reset Operation parameter is set to stop control.

If autotuning is executed when the Reset Operation parameter is set to fixed SP operation, the remaining standby time during autotuning execution will be retained.

- If the power is interrupted during standby status, the remaining standby time is held (if the Startup Operation parameter is set to Continue or Manual and the program was running and with manual operation before the power was interrupted).

● **Related Parameters**

Parameter name	Display	Setting range	Default	Level
Standby Time	<i>Stb</i>	<i>0.00 to 99.59</i> (hours.minutes) <i>0.00 to 99.23</i> (days.hours)	<i>0.00</i>	Adjustment Level
Standby Time Unit	<i>S-U</i>	<i>H-M</i> : Hours.Minutes <i>d-H</i> : Days.Hours	<i>H-M</i>	Advanced Function Setting Level

**Monitoring the Remaining Standby Time**

Parameter name	Display	Setting range	Default	Level
Remaining Standby Time Monitor	<i>StbM</i>	<i>0.00 to 99.59</i> (hours.minutes) <i>0.00 to 99.23</i> (days.hours)		Operation Level

**5-15-14 Changing the SP Mode**

- You can change the SP mode if the reset operation is set to stop control.
- The following figure shows an example of changing between Program SP Mode and Fixed SP Mode during program operation.

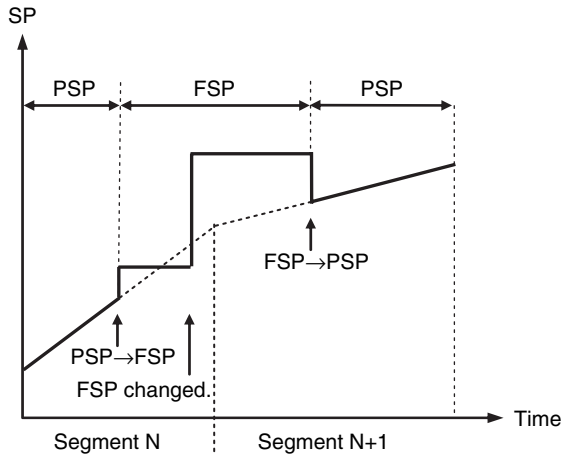

- The procedure for the above operation is given below.

- 1** Segment N is changed from Program SP Mode to Fixed SP Mode.
- 2** The fixed SP is changed.
- 3** Operation is changed from Fixed SP Mode to Program SP Mode in segment N+1.

- The program will not start if the Reset Operation parameter is set to stop control and the setting of the Run/Reset parameter is changed to Run in Fixed SP Mode.

## ● Related Parameters

### Changing between Program SP Mode and Fixed SP Mode with a Key Operation

Parameter name	Display	Setting range	Default	Level
SP Mode	<i>SPMd</i>	<i>PSP</i> : Program SP <i>FSP</i> : Fixed SP	<i>PSP</i>	Adjustment Level

### Changing between Program SP Mode and Fixed SP Mode with an Event Input

Parameter name	Display	Setting range	Default	Level
Event Input Assignment	<i>EV-1</i> <i>EV-2</i> <i>EV-3</i> <i>EV-4</i> <i>EV-5</i> <i>EV-6</i>	<i>SPM</i> : Program SP Mode/Fixed SP Mode	Event Input Assignment 1: <i>RR-1</i> Event Input Assignment 2: <i>RdV</i> Event Input Assignment 3 to 6: <i>NONE</i>	Initial Setting Level

Note: When the reset operation is Fixed SP Mode, you can change between run status and reset status to change between Program SP Mode and Fixed SP Mode.

## 5-15-15 SP Tracking

You can use SP tracking to prevent rapid changes in the set point when you change from Program SP Mode to Fixed SP Mode. With SP tracking, the program SP when you change the mode is used as the fixed SP.

Note: This function does not operate when you change from Fixed SP Mode to Program SP Mode.

- SP tracking will operation if the SP Tracking parameter (Advanced Function Setting Level) is set to ON.
- The following figure shows the operation with and without SP tracking when the mode is changed from Program SP Mode to Fixed SP Mode.

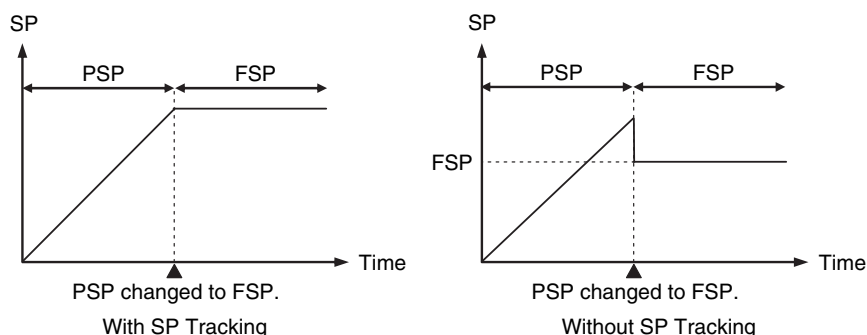

## ● Related Parameters

Parameter name	Display	Setting range	Default	Level
SP Tracking	<i>SPtR</i>	<i>ON</i> : Enabled <i>OFF</i> : Disabled	<i>OFF</i>	Advanced Function Setting Level

## 5-15-16 Operations Related to Other Functions

### **Changing to Manual Mode during Operation and Operation for Errors**

---

In the following cases, timing of program progression is continued.

- When you change to Manual Mode during program operation
- When an input error occurs during program operation
- When a potentiometer input error occurs during program operation

### **Operation When Moving to the Initial Setting Level**

---

If you move to the Initial Setting Level, program operation will stop, the control outputs will turn OFF, and the following outputs will turn OFF: time signal outputs, program end output, run output, and stage output.

# 5-16 Output Adjustment Functions

## 5-16-1 Output Limits

- Output limits can be set to control the output using the upper and lower limits to the calculated MV.
- The following MV takes priority over the MV limits.  
Manual MV\*  
MV at Reset  
MV at PV error

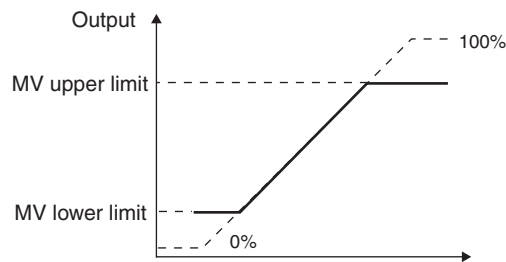

- \* When the manual MV limit is enabled, the manual MV will be restricted by the MV limit.
- For heating/cooling control, upper and lower limits are set for overall heating/cooling control. (They cannot be set separately for heating/cooling.)

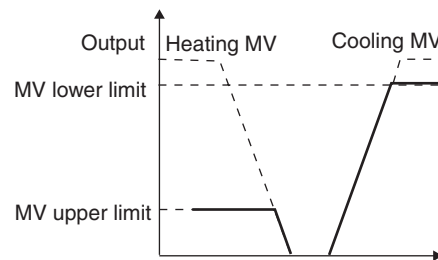

## 5-16-2 MV at Reset

You can set the MV to use during reset status.

To set the MV at Reset parameter, use the parameter mask settings and set the MV at Reset parameter (Advanced Function Setting Level) to  $dLSP$  (unmask).

- Standard Models  
For heating/cooling control, the MV at stop will apply to the cooling side if the MV is negative and to the heating side if the MV is positive. The default is 0.0, so an MV will not be output for either standard or heating/cooling control.
- Position-proportional Models  
You can select between open, close, and hold for floating control or when the Direct Setting of Position Proportional MV parameter is set to OFF. For open, only the open output turns ON. For close, only the close output turns ON. For hold, both the open output and close output turn OFF. The default setting is hold, so both outputs are turned OFF. If you set the Direct Setting of Position Proportional MV parameter to ON for close control, you can specify the valve opening. The default setting is 0.0, which means that the open output and close output will be adjusted so that the valve opening will go to 0.

## ● Related Parameters

Parameter	Setting range	Unit	Default
MV at Reset	Standard control: -5.0 to 105.0 Heating/cooling control: -105.0 to 105.0	% or none	0.0 or HOLD
	Position-proportional Control Direct Setting of Position Proportional MV parameter set to ON for close control: -5.0 to 105.0 Floating control or Direct Setting of Position Proportional MV parameter set to OFF: CLOS (Control output 2 turns ON.) HOLD (Control outputs 1 and 2 turn OFF.) OPEN (Control output 1 turns ON.)		

Note: The order of priority in respect to the manual MV and the MV at PV error is as follows: Manual MV > MV at Reset > MV at PV error.

- If the Direct Setting of Position Proportional MV parameter is set to ON, the operation is as shown below when there is a potentiometer input error.
  - MV at Reset  $\geq$  100: Open output turns ON.
  - MV at Reset  $\leq$  0: Close output turns ON.
 For any other MV at Reset, both the open output and close output will turn OFF.

### 5-16-3 MV at PV Error

You can output a fixed MV when an input error or a potentiometer error for close control occurs. To set the MV at PV Error parameter, use the parameter mask settings and set the MV at PV Error Addition parameter (Advanced Function Setting Level) to  $dL5P$  (unmask). In reset status, the setting of the MV at Reset parameter takes priority. With manual operation, the manual MV takes priority.

- Standard Models
 

For heating/cooling control, the MV at PV Error will apply to the cooling side if the MV is negative and to the heating side if the MV is positive. The default is 0.0, so an MV will not be output for either standard or heating/cooling control.
- Position-proportional Models
 

You can select between open, close, and hold for floating control or when the Direct Setting of Position Proportional MV parameter is set to OFF. For open, only the open output turns ON. For close, only the close output turns ON. For hold, both the open output and close output turn OFF. The default setting is to hold, so both outputs are turned OFF. If you set the Direct Setting of Position Proportional MV parameter to OFF for close control, you can specify the valve opening. The default setting is 0.0, which means that the open output and close output will be adjusted so that the valve opening will go to 0.

Parameter	Setting range	Unit	Default
MV at PV Error	Standard control: -5.0 to 105.0 Heating/cooling control: -105.0 to 105.0	% or none	0.0 or HOLD
	Position-proportional Control Direct Setting of Position Proportional MV parameter set to ON for close control: -5.0 to 105.0 Floating control or Direct Setting of Position Proportional MV parameter set to OFF: CLOS (Control output 2 turns ON.) HOLD (Control outputs 1 and 2 turn OFF.) OPEN (Control output 1 turns ON.)		

Note: The order of priority is as follows: Manual MV > MV at reset > MV at PV error.

- If the Direct Setting of Position Proportional MV parameter is set to ON, the operation is as shown below when there is a potentiometer input error.
  - MV at PV error  $\geq$  100: Open output turns ON.
  - MV at PV error  $\leq$  0: Close output turns ON.
 For any other MV at PV error, both the open output and close output will turn OFF.



- The order of priority of the MV is illustrated in the following diagram.

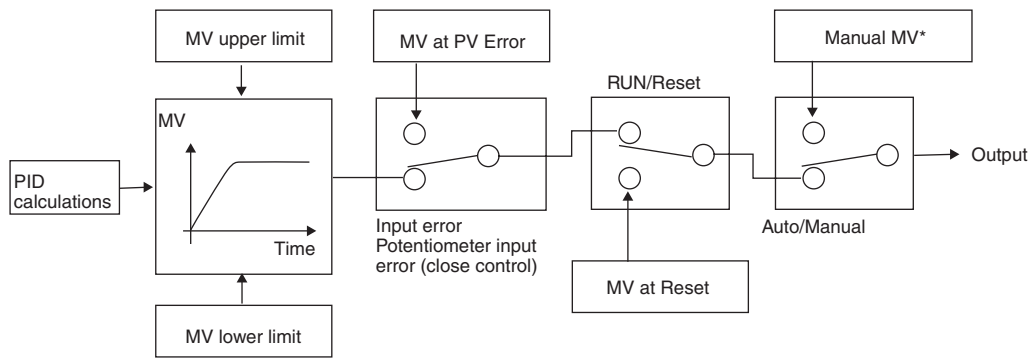

\* When the Manual MV Limit Enable parameter is set to ON, the setting range will be the MV lower limit to the MV upper limit.

# 5-17 Using the Extraction of Square Root Parameter

## 5-17-1 Extraction of Square Roots

Extraction of Square Root Enable

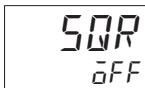

Extraction of Square Root Low-cut Point



- For analog inputs, the Extraction of Square Root parameter is provided for inputs so that differential pressure-type flow meter signals can be directly input.
- The default setting for the Extraction of Square Root parameter is OFF. The Extraction of Square Root Enable parameter must be set to ON in order to use this function.
- If the PV input (i.e., the input before extracting the square root) is higher than 0.0% and lower than the low cut point set in the Extraction of Square Root Low-Cut Point parameter, the results of extracting the square root will be 0.0%. If the PV input is lower than 0.0% or higher than 100.0%, extraction of the square root will not be executed, so the result will be equal to the PV input. The low-cut point is set as normalized data for each input, with 0.0 as the lower limit and 100.0 as the upper limit for the input setting range.

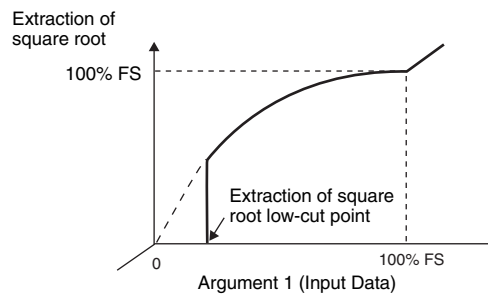

Parameter name	Setting range	Unit	Default	Level
Extraction of Square Root Enable	OFF: Disabled, ON: Enabled	---	OFF	Initial Setting Level
Extraction of Square Root Low-cut Point	0.0 to 100.0	%	0.0	Adjustment Level

This procedure sets the Extraction of Square Root Low-cut Point parameter to 10.0%.



The input type must be set for an analog input.

### Operating Procedure

- Enabling Extraction of Square Roots

<p><b>1</b> Press the  Key several times in the Initial Setting Level to display <b>SQR</b> (Extraction of Square Root Enable).</p>	<p>Initial Setting Level</p> <p>Extraction of Square Root Enable</p>
<p><b>2</b> Press the  or  Key to select <b>ON</b> (Enabled). The default is <b>OFF</b> (disabled).</p>	

- Setting the Extraction of Square Root Low-cut Point

<p><b>1</b> Press the  Key several times in the Adjustment Level to display <i>SORP</i> (Extraction of Square Root Low-cut Point).</p>	<p>Adjustment Level</p> <div style="border: 1px solid black; padding: 5px; display: inline-block;"> <p><i>SORP</i> 0.0</p> </div> <p>Extraction of Square Root Low-cut Point</p>
<p><b>2</b> Press the  or  Key to set the value to 10.0. The default is 0.0 (%).</p>	<div style="border: 1px solid black; padding: 5px; display: inline-block;"> <p><i>SORP</i> 10.0</p> </div>

## 5-18 Setting the Width of MV Variation

### 5-18-1 MV Change Rate Limit

MV Change Rate  
Limit

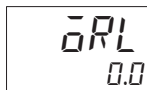

- The MV change rate limit sets the maximum allowable width of change per second in the MV (or the change per second in the valve opening for a Position-proportional Model). If the change in the MV exceeds this setting, the MV will be changed by the MV change rate limit until the calculated value is reached. This function is disabled when the setting is 0.0.
- The MV change rate limit does not function in the following situations:
  - In Manual Mode
  - During AT execution
  - During ON/OFF control
  - While resetting (during MV output when resetting)
  - During MV at PV Error output









Parameter name	Setting range	Unit	Default	Level
MV Change Rate Limit	0.0 to 100.0	%/s	0.0	Adjustment Level

This procedure sets the MV change rate limit to 5.0%/s. The related parameters are as follows:

PID ON/OFF = PID

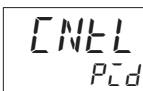
#### Operating Procedure

- Setting 2-PID Control

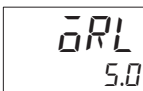
<p><b>1</b> Press the  Key several times in the Initial Setting Level to display <math>ENEL</math> (PID ON/OFF).</p>	<p>Initial Setting Level</p>  <p>PID ON/OFF</p>
<p><b>2</b> Press the  or  Key to select <math>Pd</math> (PID). The default is <math>Pd</math> (PID control).</p>	
<ul style="list-style-type: none"> <li>• Setting the MV Change Rate Limit</li> </ul>	
<p><b>1</b> Press the  Key several times in the Adjustment Level to display <math>oRL</math> (MV Change Rate Limit).</p>	<p>Adjustment Level</p>  <p>MV Change Rate Limit</p>
<p><b>2</b> Press the  or  Key to set the value to 5.0. The default is 0.0 (%/s).</p>	

## 5-19 Setting the PF Key

### 5-19-1 PF Setting (Function Key)

PF Setting (Advanced Function Setting Level)

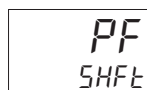

- Pressing the PF Key for at least one second executes the operation set in the PF Setting parameter. The default is *SHFT* (digit shift).

Set value	Display	Setting	Function
OFF	<i>OFF</i>	Disabled	Does not operate as a function key.
RUN	<i>RUN</i>	RUN	Specifies RUN status.
RST	<i>RSt</i>	Reset	Specifies resetting.
R-R	<i>R-R</i>	Run/Reset	Specifies reversing operation status between Run and Reset.
HOLD	<i>HOLD</i>	Hold/Clear Hold	Specifies reversing operation status between Hold and Hold Clear.
AT-2	<i>At-2</i>	100% AT Execute/Cancel	Specifies reversing the 100% AT Execute/Cancel status.*1
AT-1	<i>At-1</i>	40% AT Execute/Cancel	Specifies reversing the 40% AT Execute/Cancel status.*1 *4
ATA2	<i>AtAt2</i>	All PID 100% AT Execute/Cancel	Specifies reversing 100% AT execute/cancel status for all PID sets.*1
ATA1	<i>AtAt1</i>	All PID 40% AT Execute/Cancel	Specifies reversing 40% AT execute/cancel status for all PID sets.*1*4
LAT	<i>LASt</i>	Alarm Latch Cancel	Specifies canceling all alarm latches.*2
A-M	<i>A-M</i>	Auto/Manual	Specifies reversing the Auto/Manual status.*3
PFDP	<i>PFdP</i>	Monitor/Setting Item	Specifies the monitor/setting item display. Select the monitor setting item according to the Monitor/Setting Item 1 to 5 parameters (Advanced Function Setting Level).
SHFT	<i>SHFT</i>	Digit Shift	Operates as a Digit Shift Key when settings are being changed.

\*1 When AT cancel is specified, it means that autotuning is canceled regardless of the type of autotuning that is currently being executed.

\*2 Alarms 1 to 4, the HB alarm, and the HS alarm are cancelled.

\*3 For details on auto/manual operations using the PF Key, refer to *5-11 Performing Manual Control*.

\*4 AT-1 or ATA1 can be set for heating/cooling control or floating position-proportional control, but the function is disabled.

Note1: Pressing the PF Key for at least one second executes operation according to the set value. (However, if Digit Shift is set, operation will be in less than one second.) When the Monitor/Setting Item parameter is selected, however, the display is changed in order from Monitor/Setting Item 1 to 5 each time the key is pressed.

2: This function is enabled when PF Key Protect is OFF.

## ● Monitor/Setting Item

Monitor/Setting Item 1  
(Advanced Function Setting  
Level)

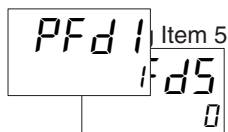

Setting the PF Setting parameter to the Monitor/Setting Item makes it possible to display monitor/setting items using the  $\llbracket$ PF $\rrbracket$  Key. The following table shows the details of the settings. For setting (monitor) ranges, refer to the applicable parameter.

Set value	Setting	Remarks	
		Monitor/Setting	Display
0	Disabled		---
1	PV/SP/Program No. Monitor and Segment No. Monitor	Can be set. (SP) <sup>*1</sup>	---
2	PV/SP/MV (Heating) (Valve Opening for Position-proportional Models)	Can be set. (SP) <sup>*1</sup>	---
3	PV/SP/MV (Cooling)	Can be set. (SP) <sup>*1</sup>	---
4	PV/SP/Remaining Segment Time	Can be set.	---
5	Program Number	Can be set.	PRG
6	Segment No. Monitor	Can be set.	SEG
7	Remaining Standby Time Monitor	Can be set.	SEbM
8	Elapsed Program Time Monitor	Can be set.	PRGE
9	Remaining program time monitor	Can be set.	PRGR
10	Elapsed Segment Time Monitor	Can be set.	SEGE
11	Remaining Segment Time Monitor	Can be set.	SEGR
12	Program Execution Repetitions Monitor	Can be set.	RPEM
13	Proportional band	Can be set.	*P
14	Integral time	Can be set.	*I
15	Derivative time	Can be set.	*D
16	Proportional Band (Cooling)	Can be set.	*I-P
17	Integral Time (Cooling)	Can be set.	*I-I
18	Derivative Time (Cooling)	Can be set.	*I-D
19	Alarm value 1	Can be set.	AL-1
20	Alarm value upper limit 1	Can be set.	AL1H
21	Alarm value lower limit 1	Can be set.	AL1L
22	Alarm value 2	Can be set.	AL-2
23	Alarm value upper limit 2	Can be set.	AL2H
24	Alarm value lower limit 2	Can be set.	AL2L
25	Alarm value 3	Can be set.	AL-3
26	Alarm value upper limit 3	Can be set.	AL3H
27	Alarm value lower limit 3	Can be set.	AL3L
28	Alarm value 4	Can be set.	AL-4
29	Alarm value upper limit 4	Can be set.	AL4H
30	Alarm value lower limit 4	Can be set.	AL4L

\*1 With the E5CC-T, only the PV and SP can be displayed.

### Setting Monitor/Setting Items

Pressing the **PF** Key in either the Operation or Adjustment Level displays the applicable monitor/setting items. Press the **PF** Key to display in order Monitor/Setting Items 1 to 5. After Monitor/Setting Item 5 has been displayed, the display will switch to the top parameter in the Operation Level.

- Note 1: Items set as disabled in the Monitor/Setting Items 1 to 5 parameters will not be displayed, and the display will skip to the next enabled setting.
- 2: While a monitor/setting item is being displayed, the display will be switched to the top parameter in the Operation Level if the **PF** Key or the **PF** Key is pressed.

This procedure sets the PF Setting parameter to PFDP, and the Monitor/Setting Item 1 parameter to 19 (Alarm Value 1).

#### Operating Procedure

- Setting the PF Key

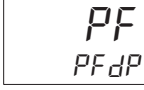
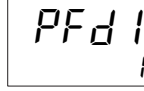
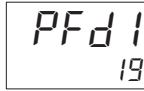
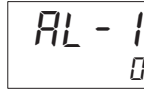
<p><b>1</b> Press the <b>PF</b> Key several times in the Advanced Function Setting Level to display <b>PF</b> (PF Setting).</p>	<p>Advanced Function Setting Level</p>  <p>PF Setting</p>
<p><b>2</b> Press the <b>▲</b> or <b>▼</b> Key to select <b>PFdP</b> (Monitor/Setting Item). The default is <b>SHFt</b> (digit shift).</p>	
<ul style="list-style-type: none"> <li>Setting the Monitor/Setting Items</li> </ul>	
<p><b>1</b> Press the <b>PF</b> Key several times in the Advanced Function Setting Level to display <b>PFd1</b> (Monitor/Setting Item 1).</p>	<p>Advanced Function Setting Level</p>  <p>Monitor/Setting Item 1</p>
<p><b>2</b> Press the <b>▲</b> or <b>▼</b> Key to select <b>19</b> (Alarm Value 1). The default is 1 (PV/SP/program number and segment number).</p>	
<p><b>3</b> Return to the Operation Level and press the <b>PF</b> Key to display <b>AL - 1</b> (Alarm Value 1).</p>	<p>Monitor/Setting Item Level</p>  <p>Monitor/Setting Item Display 1</p>



## 5-20 Displaying PV/SV Status

### 5-20-1 PV and SV Status Display Functions

#### ● PV Status Display Function (Advanced Function Setting Level)

The PV on the No. 1 display in the PV, PV/SP, PV/Manual MV, or PV/SP Manual MV Display and the control or alarm status specified for the PV status display function are alternately displayed in 0.5-s cycles.

- PV
- PV/SP\*
- PV/Manual MV (Valve Opening)
- PV/SP/Manual MV (Valve Opening)

\* This includes when the PV/SP is selected for the Monitor/Setting Item parameter.

Set value	Display	Function
OFF	<i>OFF</i>	No PV status display
Manual	<i>MANU</i>	MANU is alternately displayed during manual control.
Reset	<i>RST</i>	RST is alternately displayed while operation is in reset status.
Alarm 1	<i>ALM1</i>	ALM1 is alternately displayed during Alarm 1 status.
Alarm 2	<i>ALM2</i>	ALM2 is alternately displayed during Alarm 2 status.
Alarm 3	<i>ALM3</i>	ALM3 is alternately displayed during Alarm 3 status.
Alarm 4	<i>ALM4</i>	ALM4 is alternately displayed during Alarm 4 status.
Alarm 1 to 4 OR status	<i>ALM</i>	ALM is alternately displayed when Alarm 1, 2, 3, or 4 is set to ON.
Heater Alarm	<i>HA</i>	HA is alternately displayed when an HB alarm or HS alarm is ON.
Standby	<i>STB</i>	STB is alternately displayed while operation is on standby.

Note: The default is OFF.

Example: When RST Is Selected for the PV Status Display Function

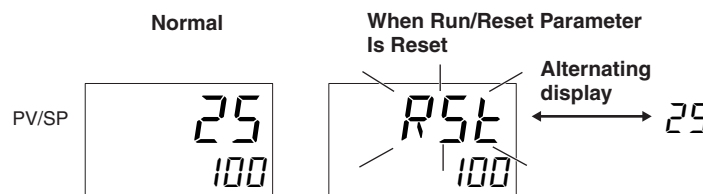

#### ● SV Status Display Function (Advanced Function Setting Level)

The SP, Manual MV, or blank on the No. 2 display in the PV/SP, PV, or PV/Manual MV Display and the control or alarm status specified for the SV status display function are alternately displayed in 0.5-s cycles.

The set values are the same as for PV Status Display Function.

Example: When ALM1 Is Selected for the SV Status Display Function

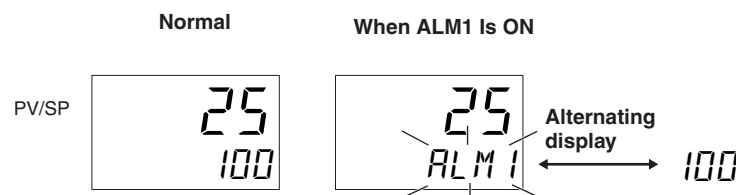



**Additional Information**

**Priority of Flashing and Alternating Displays on No. 2 Display**

The priority for flashing and alternating displays is as follows:

- (1) Alternating display with SV status display
- (2) Alternating displays/hold display during program end output

The following procedure sets the PV Status Display Function parameter to ALM1.

**Operating Procedure**

<p><b>1</b> Press the  Key several times in the Advanced Function Setting Level to display <i>PV St</i> (PV Status Display Function).</p>	<p>Advanced Function Setting Level</p> <div style="border: 1px solid black; padding: 5px; display: inline-block;"> <p><i>PV St</i> <i>OFF</i></p> </div> <p>PV Status Display Function</p>
<p><b>2</b> Press the  or  Key to select <i>ALM 1</i> (alarm 1). The default is <i>OFF</i>.</p>	<div style="border: 1px solid black; padding: 5px; display: inline-block;"> <p><i>PV St</i> <i>ALM 1</i></p> </div>
<p><b>3</b> If the Alarm 1 status is ON in Operation Level, the PV and <i>ALM 1</i> (Alarm 1) will be alternately displayed.</p>	<p>Operation Level</p> <div style="border: 1px solid black; padding: 5px; display: inline-block;"> <p><i>25</i> <i>100</i></p> </div> <p>←→ <i>ALM 1</i></p>

## 5-21 Controlling Valves (Can Be Used with a Position-proportional Model)

You can use position-proportional control to control a valve with a control motor. With position-proportional control, you can use either close control or floating control.



### Precautions for Correct Use

The following functions cannot be used with position-proportional control.

- ON/OFF control
- P and PD control during floating control
- 40% AT during floating control
- LBA
- HB and HS alarms

### ● Control Method

Close control	A potentiometer is connected and the valve opening and travel time are used to control valve operation. Always perform motor calibration before actual operation.
Floating control	Valve operation is controlled without a potentiometer by estimating the valve opening from the travel time. Always set the travel time before actual operation. To monitor the valve opening, connect a potentiometer and perform motor calibration.

### ● Motor Calibration and Valve Opening Monitor

The valve position is calibrated and the travel time from completely open to completely closed is set automatically. You can then check the valve opening with the Valve Opening Monitor parameter. If you set the Motor Calibration parameter to ON, the valve will open completely and close completely, and then the setting of the parameter will change to OFF when the measurement has been completed. The open/closed position counts in the measurement results are set in the Valve Completely Open Position and Valve Completely Closed Position parameters and the potentiometer resistance range is set in the Potentiometer Specification Setting parameter. "ERR" will be displayed if any of the following errors occurs during execution. If an error occurs, check the wiring and other factors and execute motor calibration again.

- The potentiometer input value does not change or changes backward between completely open and completely closed because the wiring is wrong.
- The value of the potentiometer input is incorrect because of a broken wire, noise, or other factor.

Note: Do not change to any other parameter during calibration.

Input contacts	Status
OFF	Wait operation disabled.
ON	Wait operation enabled.

### ● Travel Time

The Travel Time parameter is set to the time from when the valve is completely open until it is completely closed. The Travel Time parameter is set automatically when motor calibration is performed.

Note: You cannot monitor the valve opening simply by setting the Travel Time parameter. To monitor the valve opening, always perform motor calibration.

### ● Compensating Valve Positions

There are two ways to compensate valve positions: motor calibration and manual setting. Motor calibration was previously described. For calibration with manual settings, another digital controller is used to execute motor calibration and the automatically calculated travel time, valve completely closed position, valve completely open position, and potentiometer specification setting are set together in this Digital Controller. However, these settings will depend on the equipment. When precise operation is required, execute motor calibration separately for each piece of equipment.

### ● Position Proportional Dead Band and Open/Close Hysteresis

When the difference between the MV and the valve opening is within the value that is set for the Position Proportional Dead Band, opening or closing the valve will be stopped to prevent the valve from deteriorating. The Open/Close Hysteresis parameter is used to offset the ON and OFF points when opening and closing the valve. Refer to the following figure for details.

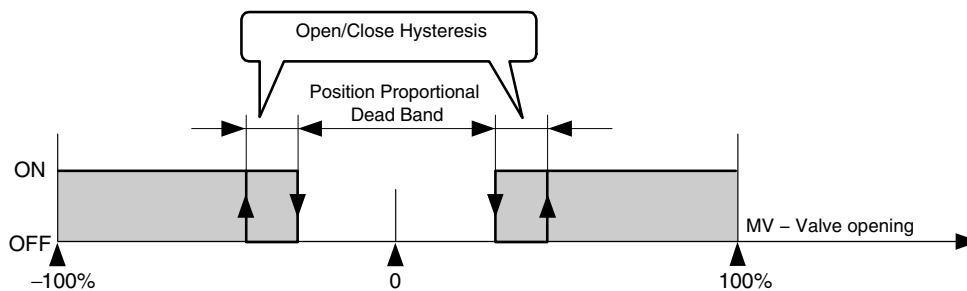

### ● PV Dead Band

When the PV enters the PV dead band, any unnecessary output is stopped to prevent the valve from deteriorating.

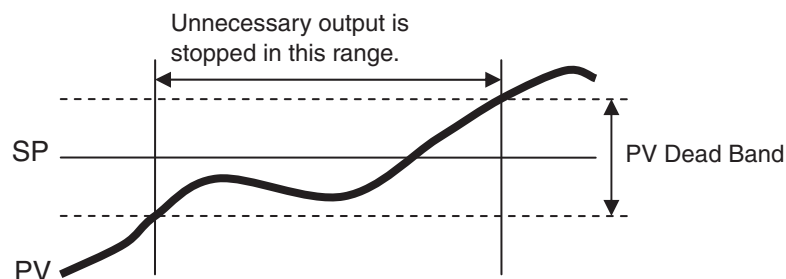

### ● Manual MV, MV at Reset, and MV at PV Error

Refer to the following sections.

Manual PV: *5-11-1 Manual MV*

MV at Reset and MV at PV Error: *5-16 Output Adjustment Functions*

## ● Related Displays and Parameters

Parameter name	Display	Set (monitor) values	Default	Level
Close/Floating	$\overline{LFL}$	FLOT: Floating control CLOS: Close control	FLOT	Initial Setting Level
Motor Calibration	$\overline{RLb}$	OFF ON ERR (Error occurred.)	OFF	
Travel Time	$\overline{Mat}$	0 to 999 (s)	30	
Valve Completely Closed Position	$\overline{VL-L}$	0 to 9,999	0	
Valve Completely Open Position	$\overline{VL-O}$	0 to 9,999	9999	
Potentiometer Input Specification	$\overline{PMS}$	0 to 5	0	Operation Level
Valve Opening Monitor	$\overline{V-M}$	Normal: -10.0% to 110.0% Error: ----*	---	
Position Proportional Dead Band	$\overline{db}$	Close control: 0.1% to 10.0%	4.0	Adjustment Level
		Floating control: 0.1% to 10.0%	2.0	
Open/Close Hysteresis	$\overline{OL-H}$	0.1 to 20.0	0.8	Advanced Function Setting Level
PV Dead Band	$\overline{P-db}$	0 to 9999	0.0	

\* Motor calibration not performed, potentiometer not connected, or potentiometer input error.

# 5-22 Logic Operations

## 5-22-1 The Logic Operation Function (CX-Thermo)

- The logic operation calculates the Controller status (alarms, run/reset, auto/manual, etc.) and the external event input status as 1 or 0, and outputs the result to a work bit. The work bit status can be output to auxiliary or control outputs, and operating status can be switched according to the work bit status.
- Work bit logic operation can be set from 1 to 8. Set them to *No operation (Always OFF)* (the default) when the work bits are not to be used.
- When logic operations are being used, a dot will be displayed between the first two digits on the No. 2 display of the Adjustment Level display

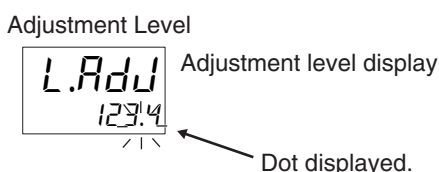

Note: The four numeric digits to identify the product code are displayed in the No. 2 display.

## 5-22-2 Using Logic Operations

Logic operations are set using the CX-Thermo.

### ● Starting Logic Operations

There are two ways to start logic operations.

- Select *Logic Operation Editor* from the CX-Thermo tree, and click the **Start** Button.

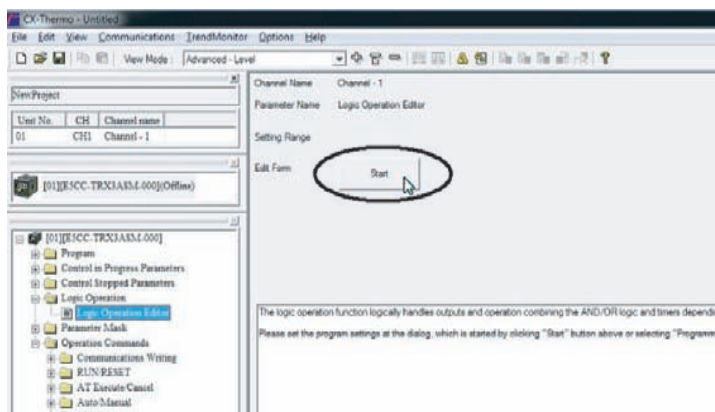

- Select **Logic Operation Editor** from the CX-Thermo Options Menu.

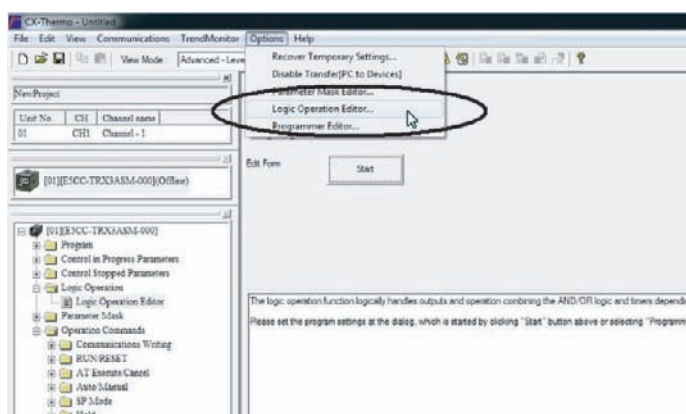

## ● Making the Settings

The following display will appear on the Logic Operation Editor Setting Window. Set each of the parameters.

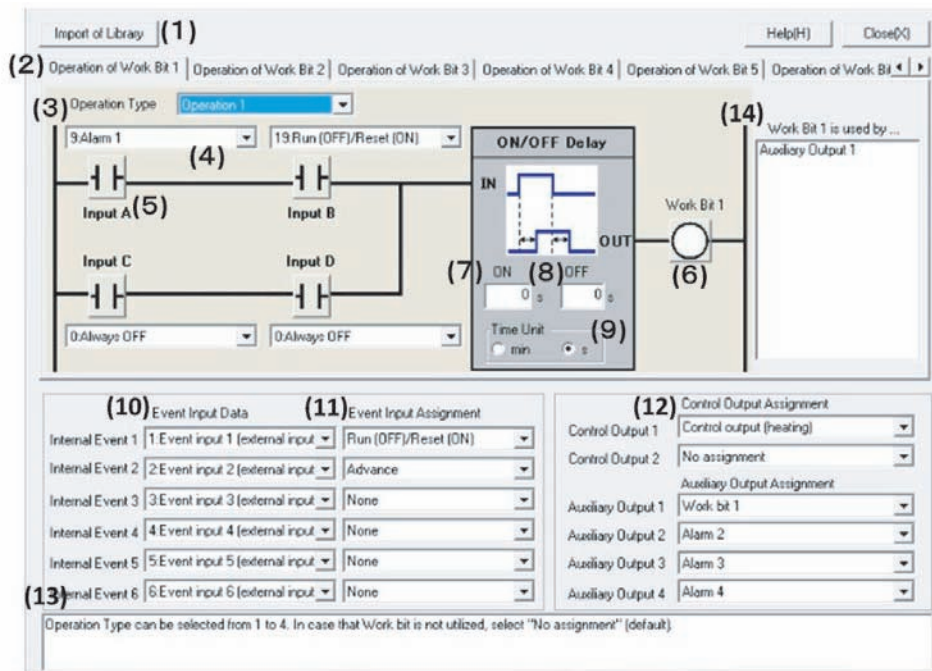

### (1) Displaying the Library Import Dialog Box

Logic operation samples for specific cases are set in the library in advance. Examples of settings for specific cases are loaded by selecting them from the library list and clicking the **OK** Button.

Example: Selecting Library 1

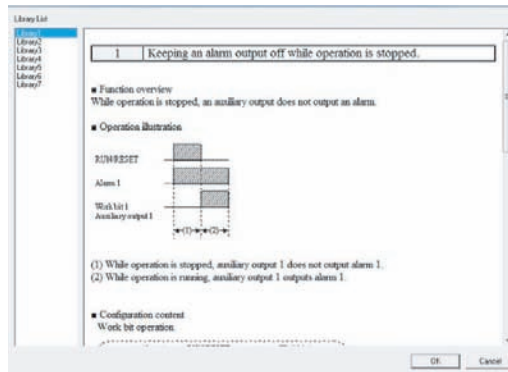

### (2) Switching Work Bit Operations

Select the work bit logic operations from the Operation of Work Bit 1 to Operation of Work Bit 8 Tab Pages.

**(3) Selecting the Operation Type**

From one to four operations are supported. If work bits are not to be used, set them to *No operation (Always OFF)* (the default).

- No operation (Always OFF)

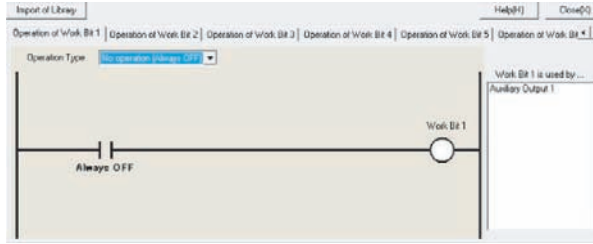

- Operation 1

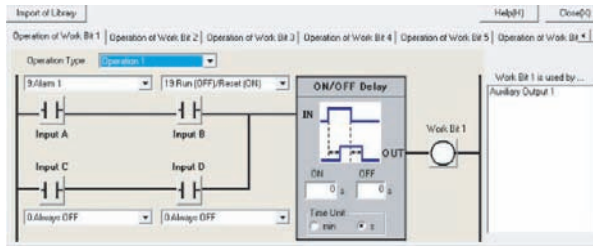

(A and B) or (C and D)  
When conditions A and B or conditions C and D are satisfied

- Operation 2

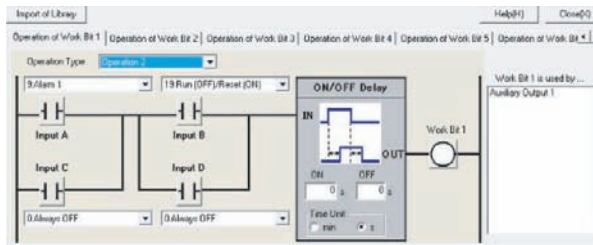

(A or C) and (B or D)  
When condition A or C and condition B or D are satisfied

- Operation 3

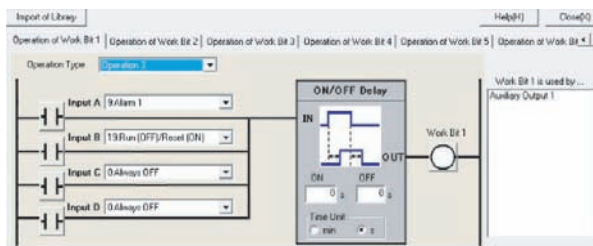

A or B or C or D  
When condition A, B, C or D is satisfied

- Operation 4

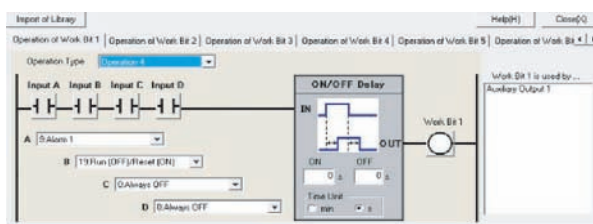

A and B and C and D  
When conditions A, B, C and D are all satisfied



**(4) Selecting Input Assignments**

Select the input assignment for the work bit logic operation from the following settings.

Parameter name	Setting range
Work Bit 1 Input Assignment A	0. Always OFF
	1. Always ON
	2. ON for one cycle when power is turned ON
	3. Event input 1 (external input)*
	4. Event input 2 (external input)*
	5. Event input 3 (external input)*
	6. Event input 4 (external input)*
	7. Event input 5 (external input)*
	8. Event input 6 (external input)*
	9. Alarm 1
	10. Alarm 2
	11. Alarm 3
	12. Alarm 4
	13. Control output (heating)
	14. Control output (cooling)
	15. Input error
	16. HB (heater burnout) alarm
	17. HS alarm
	18. Auto/Manual
	19. Run/Reset
	20. Hold
	21. PSP/FSP
	22. AT Execute/Cancel
	23. Ramp
	24. Standby
	25. Wait
	26. Time signal 1
	27. Time signal 2
	28. Program end outputs
	29. Stage
	30. Program number switch, bit 0
	31. Program number switch, bit 1
	32. Program number switch, bit 2
	33. Reserved
	34. Segment number, bit 0
	35. Segment number, bit 1
	36. Segment number, bit 2
	37. Segment number, bit 3
	38. Segment number, bit 4
	39. Work bit 1
	40. Work bit 2
	41. Work bit 3
	42. Work bit 4
	43. Work bit 5
	44. Work bit 6
	45. Work bit 7
46. Work bit 8	
Work Bit 1 Input Assignment B	Same as for work bit 1 input assignment A
Work Bit 1 Input Assignment C	Same as for work bit 1 input assignment A
Work Bit 1 Input Assignment D	Same as for work bit 1 input assignment A

Parameter name	Setting range
to	to
Work Bit 8 Input Assignment D	Same as for work bit 1 input assignment A

\* The event inputs that can be used depend on the Controller model.

**(5) Switching between Normally Open and Normally Closed for Inputs A to D**

Click the condition to switch between normally open and normally closed inputs A to D.

Normally open	Normally closed

**(6) Switching between Normally Open and Normally Closed for Work Bits**

Click the condition to switch between normally open and normally closed work bits.

Normally open	Normally closed

**(7) Setting ON Delay Times**

When an input with ON delay turns ON, the output will turn ON after the set delay time has elapsed. The setting range is 0 to 9,999. The default is 0 (disabled).

**(8) Setting OFF Delay Times**

When an input with OFF delay turns OFF, the output will turn OFF after the set delay time has elapsed. The setting range is 0 to 9,999. The default is 0 (disabled).

**(9) Switching ON/OFF Delay Time Unit**

Select either seconds or minutes for the ON/OFF delay time unit. The default is seconds. If the Work Bit \* Operation Type is set to anything but OFF, the Work Bit \* ON Delay and Work Bit \* OFF Delay will be displayed in the Adjustment Level and the settings can be changed with key operations.

**(10) Changing Event Input Data**

Select the event input conditions from the following setting ranges.

Parameter name	Setting range
Internal event 1	0. Not assigned.
	1. Event input 1 (external input)
	2. Event input 2 (external input)
	3. Event input 3 (external input)
	4. Event input 4 (external input)
	5. Event input 5 (external input)
	6. Event input 6 (external input)
	7. Work bit 1
	8. Work bit 2
	9. Work bit 3
	10. Work bit 4
	11. Work bit 5
	12. Work bit 6
	13. Work bit 7
	14. Work bit 8

Parameter name	Setting range
Internal event 2	Same as for Event Input Data 1.
Internal event 3	Same as for Event Input Data 1.
Internal event 4	Same as for Event Input Data 1.
Internal event 5	Same as for Event Input Data 1.
Internal event 6	Same as for Event Input Data 1.

Note: The internal event data can be changed from the default setting even if there is no event input terminal (external input). By changing the default setting, the event input assignment parameters will be displayed at the Controller display and can be set from the Controller.

### (11) Changing the Event Input Assignment Function

Select the setting for the internal event assignment.

When a work bit is selected as event input data, Communications Write Enable/Disable cannot be assigned to an event input.

### (12) Changing Control Output and Auxiliary Output Settings

Control output and auxiliary output assignments can be changed. The items that can be changed depend on the Controller model. For details, refer to *4-6 Setting Output Specifications*.

Assigning a work bit to either a control output or to an auxiliary output is also considered to be the same as assigning an alarm. For example, if work bit 1 is set for the Auxiliary Output 1 Assignment parameter, then alarms 1 to 4 have been assigned.

### (13) Displaying Parameter Guides

A description of the parameters can be displayed.

### (14) Displaying the Work Bit Use Destinations

Display a list of destinations where the work bits are used.

### Operating Procedure

This procedure uses event input 2 to change Run/Reset status.

Event input 2 ON: RUN

Event input 2 OFF: Reset

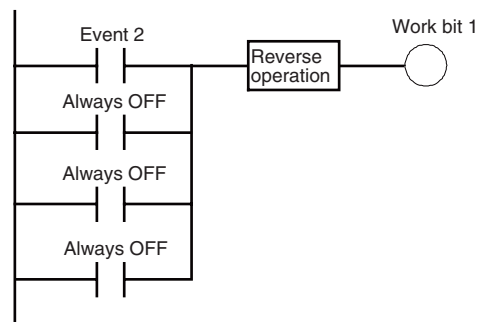

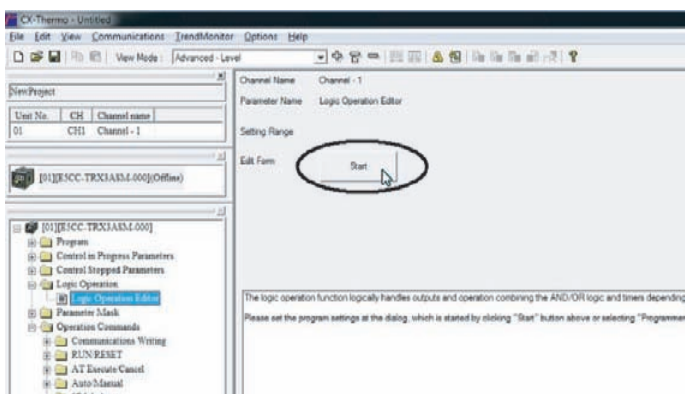

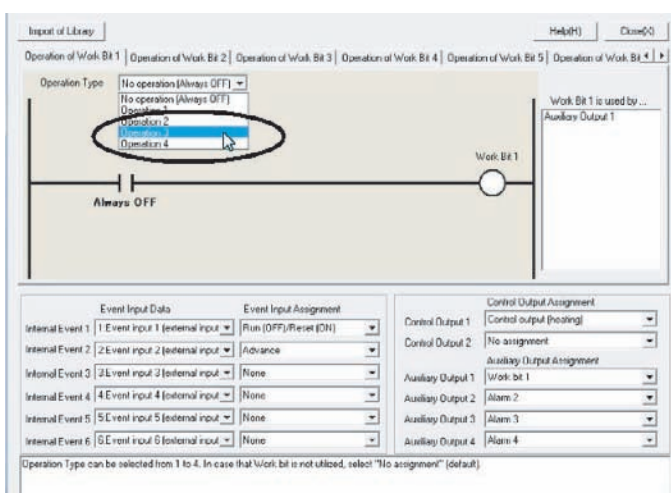

1. Select *Logic Operation Editor* from the CX-Thermo tree, and click the **Start** Button.

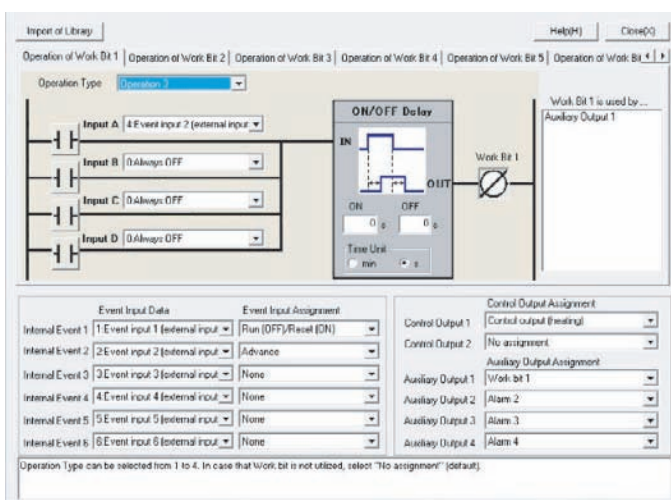

2. The Logic Operation Editor will be displayed. Confirm that the screen for work bit 1 is displayed, and select *Operation 3* from the *Operation Type* Field.



3. Set the operation by selecting one of the following:  
 Work bit 1 input assignment A = 4: Event input 2 (external input)  
 Work bit 1 input assignment B = 0: Always OFF  
 Work bit 1 input assignment C = 0: Always OFF  
 Work bit 1 input assignment D = 0: Always OFF

4. Invert work bit 1. Click  to change it to  (Normally closed).  
 5. Run/Reset is assigned to event input 2. Set the event input data for event input 2 to 2 (event input 2 (external input)), and set the Event Input 2 Assignment parameter to Run (OFF)/Reset (ON) (Program Start).

6. Closing the Logic Operation Editor Dialog Box  
 Click the **Close** Button.

This completes the procedure for setting parameters using the CX-Thermo. Transfer the settings to the Controller to set the Controller. Refer to CX-Thermo help for the procedure to transfer the settings.

Operating Procedure

This procedure outputs alarm 1 status to auxiliary output 1 during operation (RUN). A library object is used to make the setting.

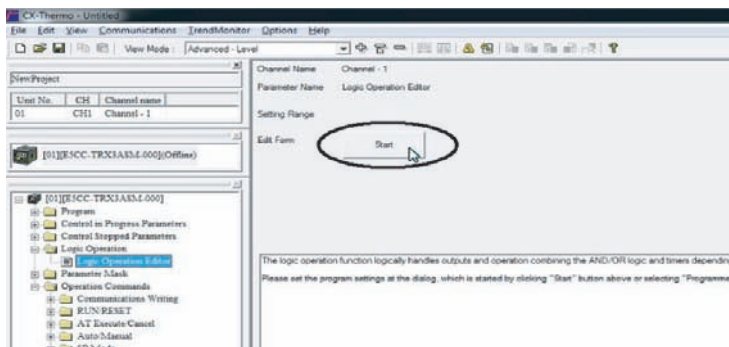
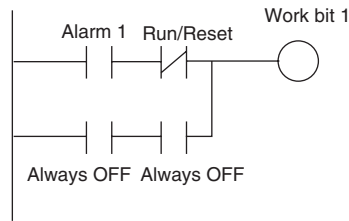

1. Select **Logic Operation Editor** from the CX-Thermo tree, and click the **Start** Button.

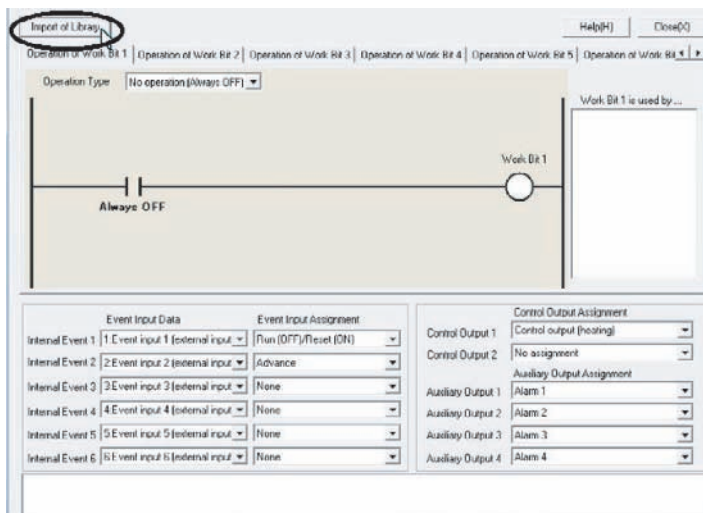

2. Click the **Import of Library** Button.

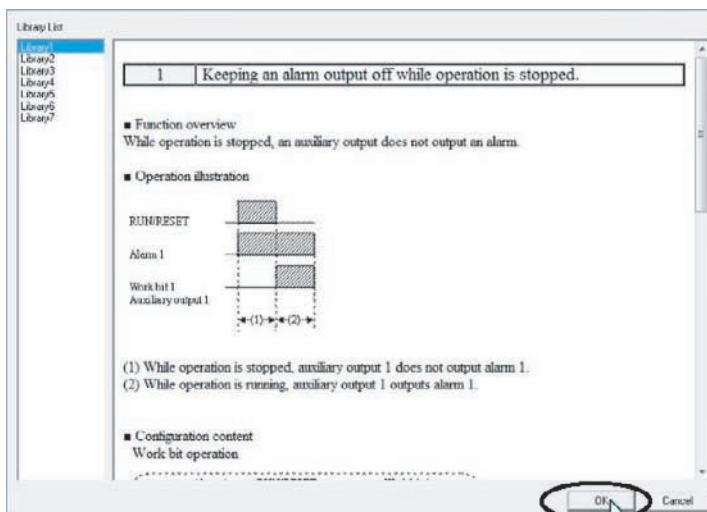

3. Select **Library 1** from the library list, and then click the **OK** Button.  
Check the following settings:  
Work Bit 1 Operation Type = Operation 1, Work Bit 1 Input Assignment A = 9 (alarm 1), Work Bit 1 Input Assignment B = 19 (invert for Run/Reset), Work Bit 1 Input Assignment C = 0 (always OFF), Work Bit 1 Input Assignment D = 0 (always OFF), Auxiliary Output 1 = Work bit 1.

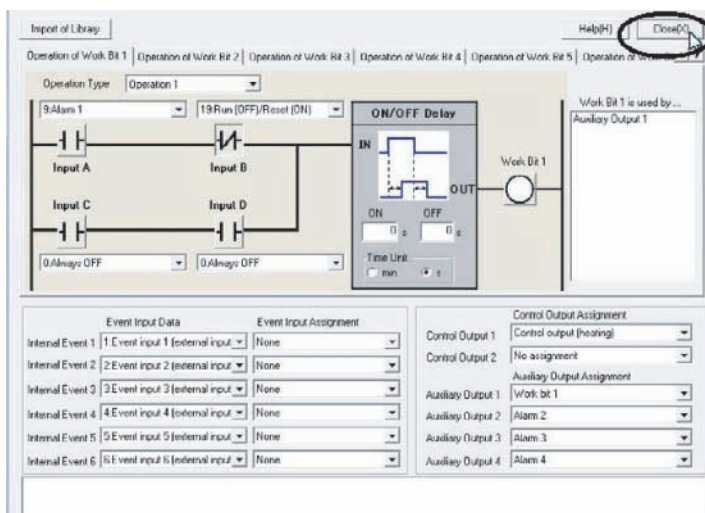

4. Closing the Logic Operation Editor Dialog Box  
Click the **Close** Button.

This completes the procedure for setting parameters using the CX-Thermo. Transfer the settings to the Controller. Refer to CX-Thermo help for the procedure to transfer the settings.

# 5-23 Using the CX-Thermo to Set Programs

## 5-23-1 Introduction

You can use the programming setting functions of the CX-Thermo to easily and visually set programs. Use CX-Thermo version 4.61 or higher.

Refer to the following sections for the setting procedures with the keys on the Digital Controller and for information on the parameters.

- *4-2 Initial Setup Examples through Starting Program Operation* on page 4-10
- *4-7 Setting Programs* on page 4-27
- *5-15 Program-related Functions* on page 5-53
- *Section 6 Parameters* on page 6-1



### Additional Information

The Digital Controller receives the power supply required for setup from the computer through the USB bus.\* You do not have to wire a power supply to the Digital Controller to set programs with the CX-Thermo or with the keys on the Digital Controller.

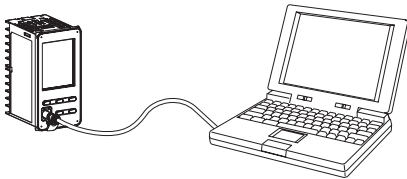

\*The USB bus power supply is used to display and set parameters. The control outputs will not operate.

## 5-23-2 Using the Program Setting Functions

You start the Programmer Editor to set programs with the CX-Thermo. Use the following procedures to start and end the Programmer Editor.

### Starting the Programmer Editor

There are the following two methods that you can use to start the Programmer Editor.

#### ● Method 1

- 1 Select *Programmer Editor* from the CX-Thermo tree, and click the Start Button.

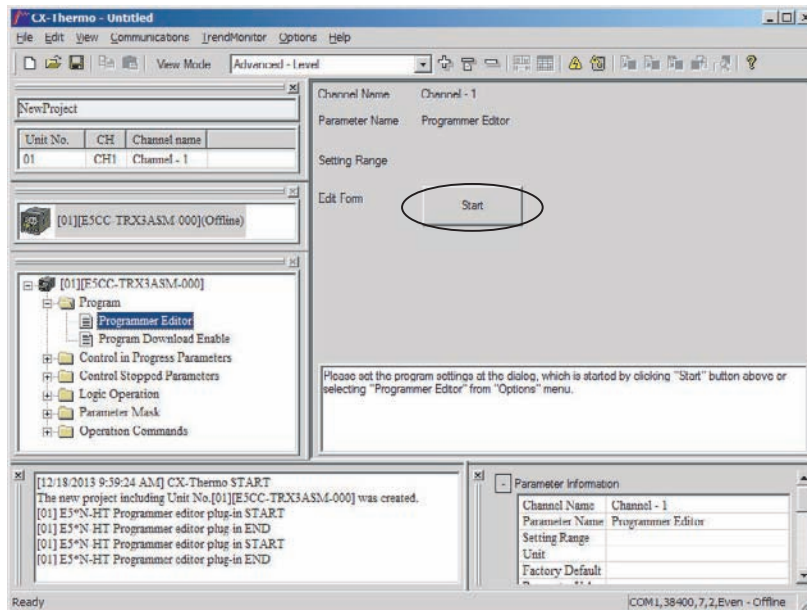

The Programmer Editor will be started.

#### ● Method 2

- 1 Select *Programmer Editor* from the CX-Thermo Options Menu.

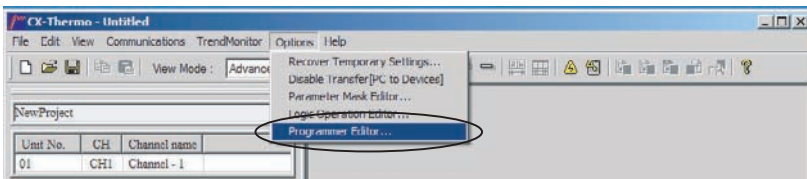

The Programmer Editor will be started.

### Ending the Programmer Editor

#### ● Method 1

- 1 Click the Close Button at the upper right corner of the Programmer Editor.



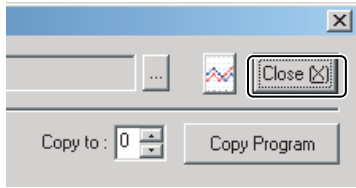

The Programmer Editor will be ended.

### 5-23-3 Names and Functions of Objects in the Programmer Editor

#### Names of Objects in the Programmer Editor

You can set the following items in the Programmer Editor.

- **Program Settings**

Set programs on the Parameter Tab Pages.

- **Copying Programs**

Use the program copy fields and button to copy programs.

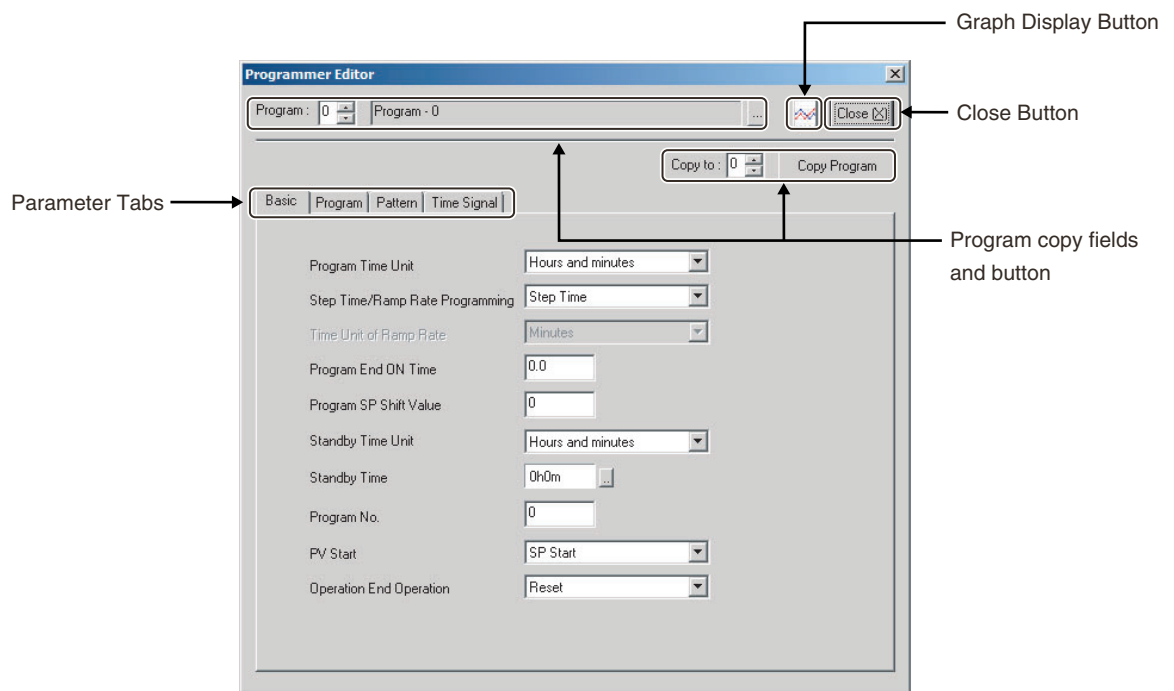

#### Additional Information

If you roll over the setting for any parameter in the Programmer Editor, a description of the parameter will be display in a tooltip.

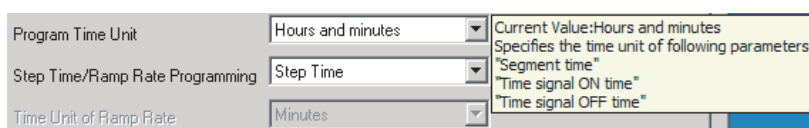

## Parameter Tab Pages

This section describes the parameters that are displayed on each tab page.

### ● Basic Tab Page

Use this tab page to set the parameters that are used by all programs.

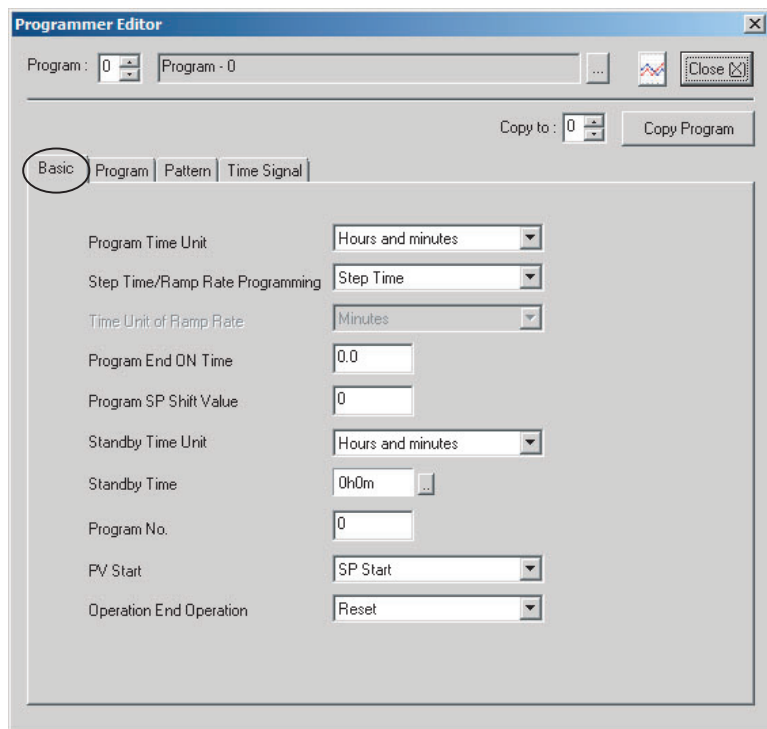

Parameter name	Description	Controller Setting Level	Page
Program Time Unit	This parameter sets the time unit for the program.	Initial Setting Level	6-58
Step Time/Ramp Rate Programming (Rate of Rise Programming)	This parameter specifies the segment setting method when a program is set.	Initial Setting Level	6-59
Time Unit of Ramp Rate	This parameter sets the time unit for the denominator of the Segment Slope parameter.	Initial Setting Level	6-59
Program End ON Time	This parameter sets the pulse width of the program end output.	Advanced Function Setting Level	6-82
Program SP Shift Value	This parameter performs a fixed-rate compensation (1-point compensation) for the program SP (PSP).	Adjustment Level	6-35
Standby Time Unit	This parameter sets the unit for the standby time.	Advanced Function Setting Level	6-82
Standby Time	This parameter is used to set the time from when the run command is executed until the program starts operation.	Adjustment Level	6-34
Program Number	This parameter specifies the program number to use to start program operation.	Operation Level	6-10
PV Start	This parameter is used to set the method for starting the program.	Initial Setting Level	6-62
Operation End Operation	This parameter is used to specify the operation status after the program has been completed.	Initial Setting Level	6-61

## ● Program Tab Page

Use this tab page to set the parameters that are used by all segments in one program.

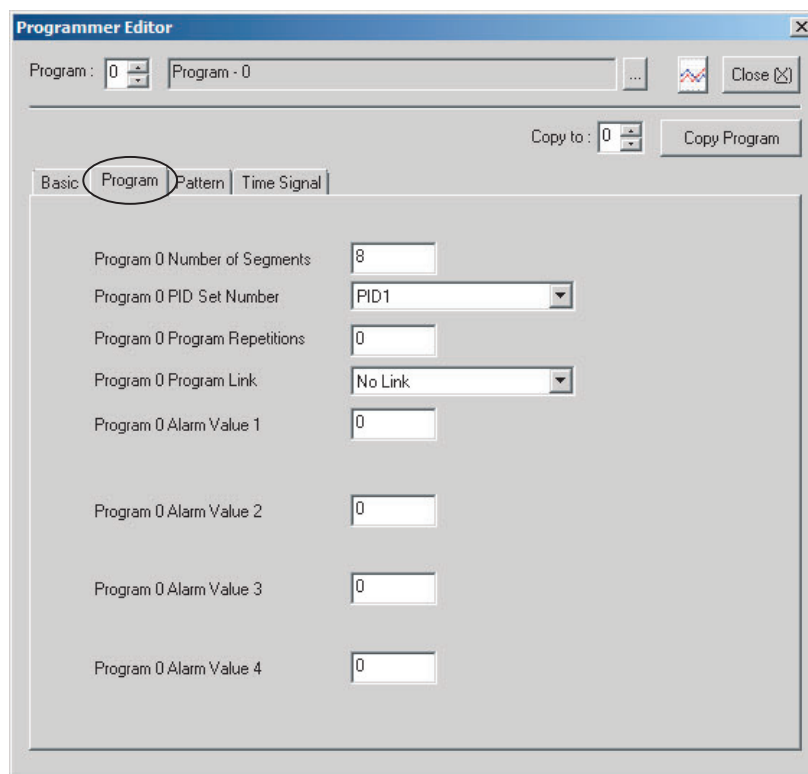

Parameter name	Description	Controller Setting Level	Page
Number of Segments Used	This parameter specifies the number of segments in the program.	Program Setting Level	6-17
PID Set No.	This parameter sets the PID set number for the specified program number.	Program Setting Level	6-20
Program Repetitions	This parameter is used to repeat the program the specified number of times.	Program Setting Level	6-22
Program Link Destination	This parameter sets the destination after the program. Once a program has been completed, the operation will continue with the program number specified for this parameter.	Program Setting Level	6-22
Alarm Value 1	These parameters set the alarm values for alarms 1 to 4 of the specified program.	Program Setting Level	6-20
Alarm Value 2			
Alarm Value 3			
Alarm Value 4			

● **Pattern Tab Page**

Use this tab page to set each of the segments in a program.

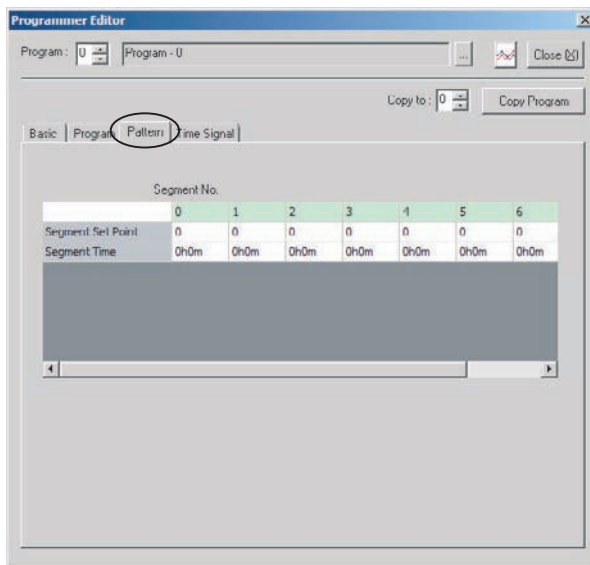

Parameter name	Description	Controller Setting Level	Page
Segment Set Point	This parameter sets the SP for the specified segment number.	Program Setting Level	6-18
Segment Time	This parameter sets the segment time for the specified segment number. For rate of rise programming, this parameter sets the time for a soak segment.	Program Setting Level	6-19

● **Time Signal Tab Page**

Use this tab page to set the time signals for a program.

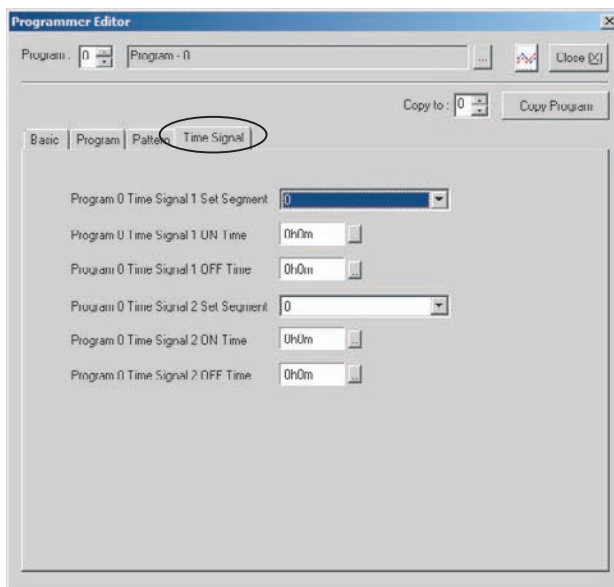

Parameter name	Description	Controller Setting Level	Page
Time Signal 1 and 2 Set Segment	These parameters set the segment numbers that will use time signals.	Program Setting Level	6-22
Time Signal 1 and 2 ON Time	These parameters set the ON times for the time signals.	Program Setting Level	6-23
Time Signal 1 and 2 OFF Time	These parameters set the OFF times for the time signals.	Program Setting Level	6-23

### 5-23-4 Program Setting Procedures

This section provides example setting procedures for step time programming and rate of rise programming for the following program pattern.

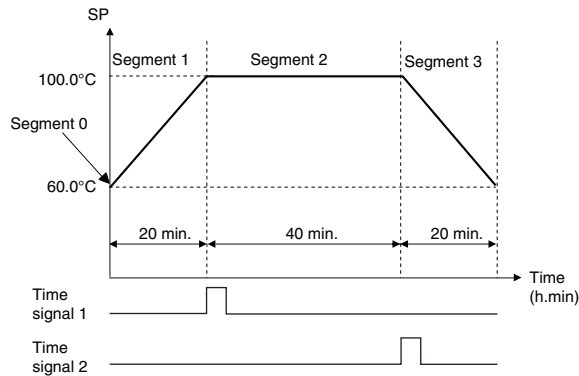

### Example Procedure for Step Time Programming

- 1 On the Basic Tab Page, set the Step Time/Ramp Rate Programming (Rate of Rise Programming) Box to *Step Time*.

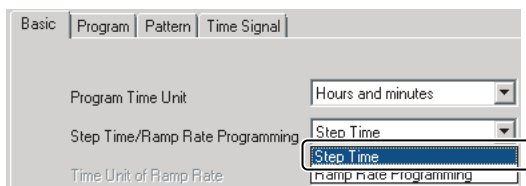

The default setting is *Step Time*.

- 2 On the Program Tab Page, set the Program 0 Number of Segments Box to 4.

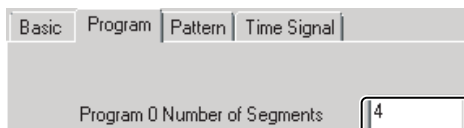

The default setting is 0.

- 3 On the Pattern Tab Page, set the Segment Set Point and Segment Time Boxes to the values given below.

Segment No.	0	1	2	3
Segment Set Point	60	100	100	60
Segment Time	0h0m	0h20m	0h40m	0h20m

Segment No.	0	1	2	3
Segment Set Point	60°C	100°C	100°C	60°C
Segment Time	0 min.	20 min.	40 min.	20 min.

- 4** On the Time Signal Tab Page, set the segments, ON times, and OFF times to the values given below.

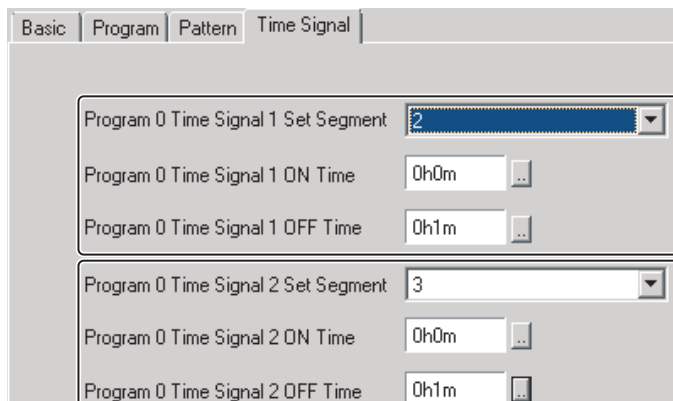

Program 0 time signal parameter	Set value
Time Signal 1 Set Segment	2
Time Signal 1 ON Time	0 min.
Time Signal 1 OFF Time	1 min.
Time Signal 2 Set Segment	3
Time Signal 2 ON Time	0 min.
Time Signal 2 OFF Time	1 min.

- 5** Click the Graph Display Button in the upper right corner of the Programmer Editor.

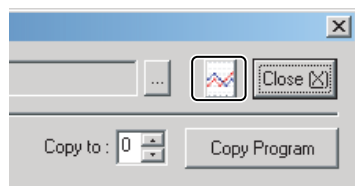

The program pattern that you set will be displayed in the Preview Dialog Box.

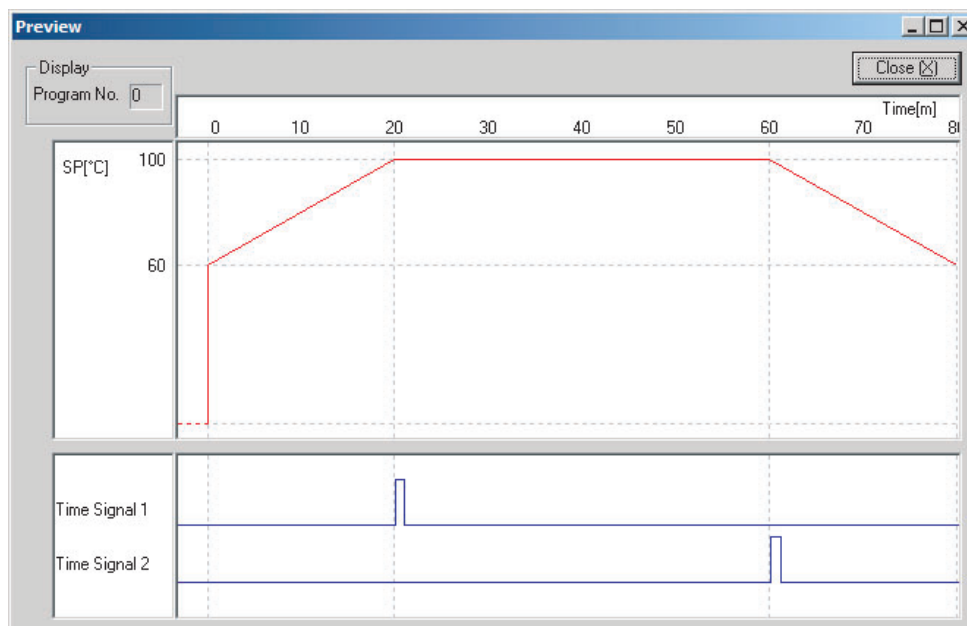

## Example Procedure for Rate of Rise Programming

- 1 On the Basic Tab Page, set the Step Time/Ramp Rate Programming (Rate of Rise Programming) Box to *Ramp Rate Programming*.

The screenshot shows the 'Basic' tab selected. The 'Program Time Unit' is set to 'Hours and minutes'. The 'Step Time/Ramp Rate Programming' dropdown menu is open, with 'Ramp Rate Programming' selected. The 'Time Unit of Ramp Rate' is also visible.

The default setting is *Step Time*.

- 2 On the Program Tab Page, set the Program 0 Number of Segments Box to 4.

The screenshot shows the 'Program' tab selected. The 'Program 0 Number of Segments' text box contains the value '4'.

- 3 Set the Segment Type (Segment Format), Segment Set Point, Segment Rate of Rise (Segment Slope), and Segment Time Boxes on the Pattern Tab Page to the values given below.

The screenshot shows the 'Pattern' tab selected. A table displays the configuration for segments 0, 1, 2, and 3.

Segment No.	0	1	2	3
Segment Type	Step	Ramp	Soak	Ramp
Segment Set Point	60	100		60
Segment Rate of Rise		2		2
Segment Time			0h40m	

Segment No.	0	1	2	3
Segment Type (Segment Format)	Step	Ramp	Soak	Ramp
Segment Set Point	60°C	100°C	---	60°C
Segment Rate of Rise (Segment Slope)	---	2	---	2
Segment Time	---	---	40 min.	---

- 4 On the Time Signal Tab Page, set the segments, ON times, and OFF times to the values given below.

The screenshot shows the 'Time Signal' tab selected. It displays configuration for two time signals. For Time Signal 1, the 'Set Segment' is 0, and both 'ON Time' and 'OFF Time' are 0h0m. For Time Signal 2, the 'Set Segment' is 0, and both 'ON Time' and 'OFF Time' are 0h0m.

Program 0 time signal parameter	Set value
Time Signal 1 Set Segment	2
Time Signal 1 ON Time	0 min.
Time Signal 1 OFF Time	1 min.
Time Signal 2 Set Segment	3
Time Signal 2 ON Time	0 min.
Time Signal 2 OFF Time	1 min.

Note: It is assumed that the time signals are already assigned to control outputs or auxiliary outputs.

## 5 Click the Graph Display Button in the upper right corner of the Programmer Editor.

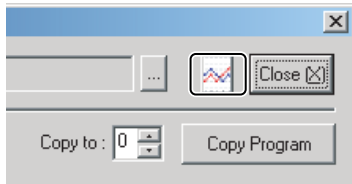

The same program pattern as given for the step time programming example will be displayed.

## Transferring the Set Program to the Digital Controller

You must transfer the data for the program settings to the Digital Controller. Refer to CX-Thermo help from the Help Menu for the procedure to transfer the settings.

## Copying a Set Program to Another Program Number

You can specify the source and destination program numbers and click the **Copy Program** Button to easily copy a set program to another program number

**1** Specify the source program number.

**2** Specify the destination program number.

**3** Click the Copy Program Button.



# 6

## Parameters

---

6-1	Conventions Used in this Section	6-2
6-2	Protect Level	6-3
6-3	Operation Level	6-7
6-4	Program Setting Level	6-16
6-5	Adjustment Level	6-24
6-6	PID Setting Level	6-44
6-7	Monitor/Setting Item Level	6-50
6-8	Manual Control Level	6-52
6-9	Initial Setting Level	6-54
6-10	Advanced Function Setting Level	6-80
6-11	Communications Setting Level	6-111

## 6-1 Conventions Used in this Section

### ● Meanings of Icons Used in this Section



Function

Describes the functions of the parameter.



Setting

Describes the setting range and default of the parameter.



Monitor

Used to indicate parameters used only for monitoring.



Operation

Describes the parameter settings, such as those for Operation Commands, and procedures.



See

Used to indicate information on descriptions in which the parameter is used or the names of related parameters.

### ● About Related Parameter Displays

Parameters are displayed only when the conditions for use given on the right of the parameter heading are satisfied. Protected parameters are not displayed regardless of the conditions for use, but the settings of these parameters are still valid.

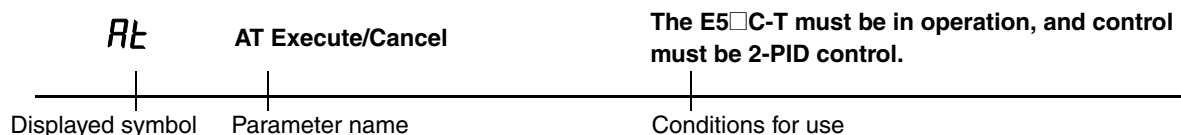

### ● The Order of Parameters in This Section

Parameters are described level by level.

The first page of each level describes the parameters in the level and the procedure to switch between parameters.

### ● Alarms

It will be specified in this section when alarms are set for the Control Output 1 or 2 Assignment parameters, or for the Auxiliary Output 1 to 4 Assignment parameters. For example, when alarm 1 is set for the Control Output 1 Assignment parameter, it will be specified that alarm 1 is assigned.

Assigning a work bit to either control output 1 or 2 or to auxiliary output 1 to 4 is also considered to be the same as assigning an alarm. For example, if work bit 1 is set for the Auxiliary Output 1 Assignment parameter, then alarms 1 to 4 have been assigned.

# 6-2 Protect Level

Four levels of protection are provided on the E5□C-T, operation/adjustment protect, initial setting/communications protect, setting change protect, and PF key protect. These protect levels prevent unwanted operation of the keys on the front panel in varying degrees.

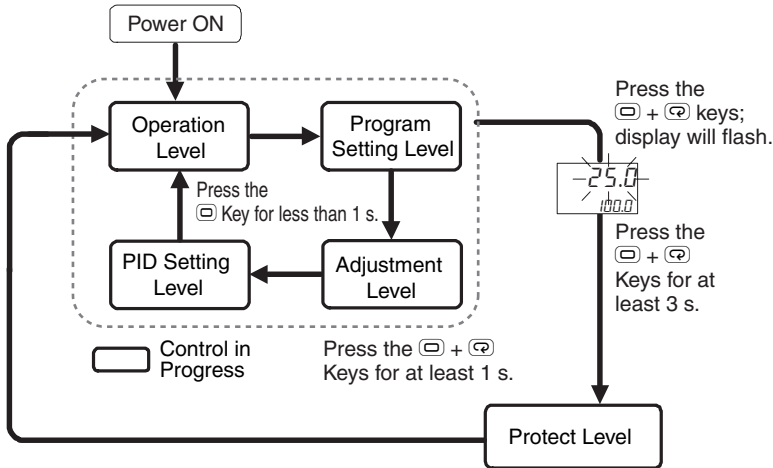

To move from any of the levels within the dotted line to the Protect Level, press the [Enter] and [Enter] Keys for at least three seconds.\*

\* The time taken to move to the Protect Level can be adjusted by changing the Move to Protect Level Time parameter setting.

Protect Level		Page
<i>PMoV</i> <sub>0</sub>	Move to Protect Level Displayed only when a password is set.	6-3
<i>oAPL</i> <sub>0</sub>	Operation/Adjustment Protect	6-4
<i>iCPL</i> <sub>0</sub>	Initial Setting/Communications Protect	6-4
<i>WtPL</i> <sub>oFF</sub>	Setting Change Protect	6-5
<i>PFPL</i> <sub>oFF</sub>	PF Key Protect	6-5
<i>PMsK</i> <sub>oN</sub>	Parameter Mask Enable	6-5
<i>PRLP</i> <sub>0</sub>	Password to Move to Protect Level	6-6

Parameters that are protected will not be displayed and their settings cannot be changed.

6-2 Protect Level

6

*PMoV* Move to Protect Level

The Password to Move to Protect Level password must not be set to 0.

The password to move to the Protect Level is entered for this parameter.



- If the correct password is entered, the Operation/Adjustment Protect parameter is displayed.



● **Related Parameters**

Password to Move to Protect Level (Protect Level): page 6-6

**OPPE** Operation/Adjustment Protect

**ICPE** Initial Setting/Communications Protect

These parameters specify the range of parameters to be protected.



### ● Operation/Adjustment Protect

Level		Set value					
		0 (default)	1	2	3	4	5
Operation Level	PV	Can be displayed	Can be displayed	Can be displayed	Can be displayed	Can be displayed	Can be displayed
	PV/SP	Can be displayed and changed	Can be displayed and changed	Can be displayed and changed	Can be displayed and changed	Can be displayed and changed	Can be displayed
	Others	Can be displayed and changed	Can be displayed and changed	Can be displayed and changed	Can be displayed and changed	Cannot be displayed and moving to other levels is not possible	Cannot be displayed and moving to other levels is not possible
Program Setting Level		Can be displayed and changed	Can be displayed and changed	Can be displayed and changed	Cannot be displayed and moving to other levels is not possible	Cannot be displayed and moving to other levels is not possible	Cannot be displayed and moving to other levels is not possible
Adjustment Level		Can be displayed and changed	Can be displayed and changed	Cannot be displayed and moving to other levels is not possible	Cannot be displayed and moving to other levels is not possible	Cannot be displayed and moving to other levels is not possible	Cannot be displayed and moving to other levels is not possible
PID Setting Level		Can be displayed and changed	Cannot be displayed and moving to other levels is not possible	Cannot be displayed and moving to other levels is not possible	Cannot be displayed and moving to other levels is not possible	Cannot be displayed and moving to other levels is not possible	Cannot be displayed and moving to other levels is not possible

- Parameters are not protected when the set value is set to 0.

### ● Initial Setting/Communications Protect

This protect level restricts movement to the Initial Setting Level, Communications Setting Level, and Advanced Function Setting Level.

Set value	Initial setting level	Communications setting level	Advanced function setting level
0	Possible to reach	Possible to reach	Possible to reach
1 (default)	Possible to reach	Possible to reach	Not possible to reach
2	Not possible to reach	Not possible to reach	Not possible to reach

**WEPE****Setting Change Protect**

The Event Input Assignment 1 to 6 parameters must not be set to enable/disable setting changes.

Changes to settings using key operations are restricted.



Function

- **Change Setting Protect**

This parameter is not displayed if the Event Input Assignment 1 to 6 parameters are set to enable/disable setting changes.



Setting

Set value	Description
OFF (default)	Settings can be changed using key operations.
ON	Settings cannot be changed using key operations. (The protect level settings, however, can be changed.)

- The all protect indication (**On**) will light when setting is ON.

**PFPE****PF Key Protect**

Function

- **PF Key Protect**

This parameter enables and disables PF Key operation.



Setting

Set value	Description
OFF (default)	PF Key enabled
ON	PF Key disabled (Operation as a function key is prohibited.)

**PMSK****Parameter Mask Enable**

Function

- This parameter turns the parameter mask function ON and OFF.



Setting

Setting range	Default
$\bar{0}N$ : Enabled, $\bar{0}FF$ : Disabled	$\bar{0}N$

- \* Parameter masks can be used to hide the displays of parameters that are not needed. You can set parameter masks with a key operation or with the Setup Tool.  
Setup Tool: CX-Thermo (EST2-2C-MV4)

---





**PRLP** Password to Move to Protect Level
 

---

This parameter is used to set the password to move to the Protect Level.



Function

- To prevent setting the password incorrectly, the  and  Keys or  and  Keys must be pressed simultaneously to set the password.



Setting

Setting range	Default
-1999 to 9999	0

Set this parameter to 0 when no password is to be set.



See

- **Related Parameters**

Move to Protect Level (Protect Level): Page 6-3



---

**Precautions for Correct Use**



---

Protection cannot be cleared or changed without the password. Be careful not to forget it. If you forget the password, contact your OMRON sales representative.

---

# 6-3 Operation Level

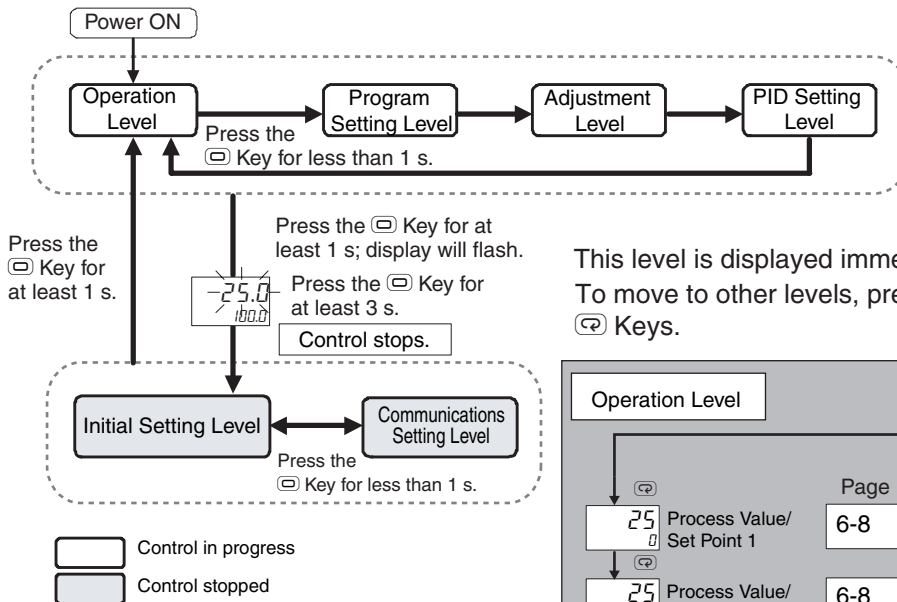
Display this level to perform control operations on the E5□C-T. You can run and reset the program or you can monitor process values and set points.



This level is displayed immediately after the power is turned ON. To move to other levels, press the  $\square$  Key or the  $\square$  and  $\square$  Keys.

Operation Level		Page			Page
$\square$	25.0 Process Value/ Set Point 1	6-8	$\square$	RPLM Program Execution Repetitions Monitor	6-12
$\square$	25.0 Process Value/ Set Point 2	6-8	$\square$	[E1] Heater Current 1 Value Monitor	6-12
$\square$	R-M Auto/Manual Switch	6-9	$\square$	[E2] Heater Current 2 Value Monitor	6-13
$\square$	PGSG Program No. Monitor/ Segment No. Monitor	6-9	$\square$	[LR1] Leakage Current 1 Monitor	6-13
$\square$	PRG Program No.	6-10	$\square$	[LR2] Leakage Current 2 Monitor	6-14
$\square$	HOLD Hold	6-10	$\square$	R-R Run/Reset	6-14
$\square$	SEG Segment No.	6-10	$\square$	[H] MV Monitor (Heating)	6-14
$\square$	StbM Remaining Standby Time Monitor	6-11	$\square$	[C] MV Monitor (Cooling)	6-15
$\square$	PRGT Elapsed Program Time Monitor	6-11	$\square$	V-M Valve Opening Monitor	6-15

Process Value/Set Point 1

PV/SP No. 1 Display Selection must not be set to 0.

Process Value/Set Point 2

PV/SP No. 2 Display Selection must not be set to 0.



The following table shows the contents of the No. 1, 2, and 3 displays, according to the setting of the PV/SP Display Screen Selection parameter.



Set value	No. 1 display	No. 2 display	No. 3 display (E5EC-T/E5AC-T only)
0	Nothing is displayed.	Nothing is displayed.	Nothing is displayed.
1	Process value	Set point	Nothing is displayed.
2	Process value	Nothing is displayed.	Nothing is displayed.
3	Set point	SP (character display)	Nothing is displayed.
4	Process value	Set point	MV monitor (heating) (valve opening for Position-proportional Models)
5	Process value	Set point	MV monitor (cooling)
6	Process value	Set point	Program No. monitor/Segment No. monitor
7	Process value	Set point	Remaining segment time

	Monitor range	Unit
Process value	Temperature input: The specified range for the specified sensor. Analog input: Scaling lower limit -5% FS to Scaling upper limit +5% FS	EU

	Setting range	Unit
Set point	SP lower limit to SP upper limit*	EU

\* The SP can be set in Fixed SP Mode (FSP). In Program SP Mode (PSP), the SP is displayed for reference only.

During temperature input, the decimal point position depends on the currently selected sensor, and during analog input it depends on the Decimal Point parameter setting.

PV/SP Display Selections

Parameter	Default
PV/SP No. 1 Display Selection	6
PV/SP No. 2 Display Selection	E5CC-T: 0 E5EC-T/E5AC-T: 7



### ● Related Parameters

PV/SP Display Selection (Advanced Function Setting Level): Page 6-107



**A-M** Auto/Manual Switch

The Event Input Assignment 1 to 6 parameters must not be set to Auto/Manual and the control must be set to 2-PID control.



Operation

- This parameter switches the Controller between Automatic and Manual Modes.
- If the  Key is pressed for at least 3 seconds when the Auto/Manual Switch parameter is displayed, the Manual Mode will be entered and the manual control level will be displayed.
- This parameter will not be displayed if an event input is set to "MANU" (auto/manual).



- **Related Parameters**

PID ON/OFF (Initial Setting Level): Page 6-63

**PGSG** Program No. Monitor/Segment No. Monitor

Function

This parameter monitors the program number and segment number that are currently being executed.

Monitor name	Monitor range
Program No.	0 to 7
Segment No.	0 to 31



Monitor

The display will appear as shown below when the program number is 2 and the segment number is 3.

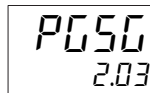

- **Related Parameters**

Program No. (Operation Level): Page 6-10

Segment No. (Operation Level): Page 6-10

Number of Segments Used (Program Setting Level): Page 6-17

**PRG** Program No.

Function

- This parameter specifies the program number to use to start program operation.
- This parameter can be used only when resetting and only when the Event Input Assignment 1 to 6 parameters are not set to switch the program number.



Setting

Setting range	Unit	Default
0 to 7	---	0



See

● **Related Parameters**

Run/Reset (Operation Level): Page 6-14

**HOLD** Hold

The Event Input Assignment 1 to 6 parameters must not be set to Hold or Hold Clear, the Run/Reset parameter must be set to Run, operation must not be on standby, and program operation must not be continuing after the completion of operation.



Function

- This parameter is used to hold the timer for program operation.
- Use the run operation, reset operation, or hold clear command to clear hold status.



Operation

The timing operation is held when the parameter is set to  $\bar{0}N$ .  
The default is  $\bar{0}FF$  (clear hold).



See

● **Related Sections**

5-15 Program-related Functions (page 5-53)

**SEG** Segment No.

The Run/Reset parameter must be set to Run, operation must not be on standby, and program operation must not be continuing after the completion of operation.



Function

This parameter is used to move the program to the beginning of a specified segment (i.e., to jump to a segment). If you jump during hold status, the hold status will be continued at the beginning of the specified segment.



Monitor

This parameter monitors the segment number that is being executed in the program before and after editing.



See

● **Related Sections**

5-15 Program-related Functions (page 5-53)

**StbM****Remaining Standby Time Monitor**    Operation must be on standby.

- This parameter monitors the remaining standby time.



Monitor range	Unit
Standby time in hours and minutes: 0.00 to 99.59	Hours and minutes, or days and hours*
Standby time in days and hours: 0.00 to 99.23	

- \* The unit is set in the Standby Time Unit parameter. (The default is H-M (hours and minutes).)



- **Related Sections**

*5-15 Program-related Functions* (page 5-53)

- **Related Parameters**

Standby Time (Adjustment Level): Page 6-34

**PRGt****Elapsed Program Time Monitor**

- This parameter monitors the time that has elapsed from the beginning of the program that is being executed.



Monitor range	Unit
0.00 to 99.59	Hours and minutes, or minutes and seconds*

- \* The unit is set in the Program Time Unit parameter. (The default is H-M (hours and minutes).)



- **Related Sections**

*5-15 Program-related Functions* (page 5-53)

**RPLM****Program Execution Repetitions Monitor**

- This parameter monitors the number of times the program has been repeated.



Monitor range	Unit
0 to 9,999	Repetitions



- **Related Sections**

5-15 *Program-related Functions* (page 5-53)

- **Related Parameters**

Program Repetitions (Program Setting Level): Page 6-22

**EE1****Heater Current 1 Value Monitor**

**HB and HS alarms must be supported.  
The HB ON/OFF parameter must be set to ON.**

This parameter measures the heater current from the CT input used for detecting heater burnout.



This parameter measures and displays the heater current value.

- Heater burnout is not detected if the ON time for the control output for heating is 100 ms or less (30 ms or less if the control period is 0.1 or 0.2 s).



Monitor range	Unit
0.0 to 55.0	A

- FFFF is displayed when 55.0 A is exceeded.
- If an alarm is output for the Heater Burnout Detection 1 parameter, the No. 1 display will flash the Heater Current 1 Value Monitor parameter.



- **Related Parameters**

Heater Burnout Detection 1 (Adjustment Level): Page 6-30

Heater Burnout Detection 2 (Adjustment Level): Page 6-31

HB ON/OFF (Advanced Function Setting Level): Page 6-84

Error Display EE1: Page A-13

**CT2****Heater Current 2 Value Monitor****HB and HS alarms must be supported (two CTs).  
The HB ON/OFF parameter must be set to ON.**

This parameter measures the heater current from the CT input used for detecting heater burnout.



This parameter measures and displays the heater current value.

- Heater burnout is not detected if the ON time for the control output for heating is 100 ms or less (30 ms or less if the control period is 0.1 or 0.2 s).



Monitor range	Unit
0.0 to 55.0	A

- *FFFF* is displayed when 55.0 A is exceeded.
- If an alarm is output for the Heater Burnout Detection 2 parameter, the No. 1 display will flash the Heater Current 2 Value Monitor parameter.



- **Related Parameters**

- Heater Burnout Detection 1 (Adjustment Level): Page 6-30
- Heater Burnout Detection 2 (Adjustment Level): Page 6-31
- HB ON/OFF (Advanced Function Setting Level): Page 6-84
- Error Display **CT2**: Page A-13

**LCR1****Leakage Current 1 Monitor****HB and HS alarms must be supported.  
The HS Alarm Use parameter must be set to ON.**

This parameter measures the heater current from the CT input used for detecting SSR short-circuits.



The heater current is measured and the leakage current 1 monitor is displayed.

- The HS alarm is not detected if the OFF time for the control output for heating is 100 ms or less (35 ms or less if the control period is 0.1 or 0.2 s).



Monitor range	Unit
0.0 to 55.0	A

- *FFFF* is displayed when 55.0 A is exceeded.
- If an alarm is output for the HS Alarm 1 parameter, the No. 1 display will flash the Leakage Current 1 Monitor parameter.



- **Related Parameters**

- HS Alarm 1 (Adjustment Level): Page 6-32
- HS Alarm 2 (Adjustment Level): Page 6-33
- HS Alarm Use (Advanced Function Setting Level): Page 6-94
- Error Display **LCR1**: Page A-13

**LCR2****Leakage Current 2 Monitor**

**HB and HS alarms must be supported (two CTs).  
The HS Alarm Use parameter must be set to ON.**

This parameter measures the heater current from the CT input used for detecting SSR short-circuits.



Function

This parameter measures and displays the heater current value.

- The HS alarm is not detected if the OFF time for the control output for heating is 100 ms or less (35 ms or less if the control period is 0.1 or 0.2 s).



Monitor

Monitor range	Unit
0.0 to 55.0	A

- *FFFF* is displayed when 55.0 A is exceeded.
- If an alarm is output for the HS Alarm 2 parameter, the No. 1 display will flash the Leakage Current 2 Monitor parameter.



See

- **Related Parameters**

HS Alarm 1 (Adjustment Level): Page 6-32

HS Alarm 2 (Adjustment Level): Page 6-33

HS Alarm Use (Advanced Function Setting Level): Page 6-94

Error Display *LCR2*: Page A-13

**R-R****Run/Reset**

This parameter specifies running or stopping the program.



Operation

Program execution will start when *RUN* (run) is selected and it will stop when *RST* (reset) is selected. The RST indicator will light while program operation is stopped.

The default is *RST*.

**MV****MV Monitor (Heating)**

This parameter is used to monitor the manipulated variable for the heating control output during operation.



Function

- During standard control, the manipulated variable is monitored. During heating/cooling control, the manipulated variables on the control output (heating) is monitored.
- The parameter is masked by default and the manipulated variable is not displayed.



Monitor

Control	Monitor range	Unit
Standard	-5.0 to 105.0	%
Heating/cooling	0.0 to 105.0	%



See

- **Related Parameters**

Parameter Mask Setting (Advanced Function Setting Level): Page 6-110

**MV Monitor (Cooling)****The control system must be set to heating/cooling control.**

This parameter is used to monitor the manipulated variable for the cooling control output during operation.



Function

- During heating/cooling control, the manipulated variable on the control output (cooling) is monitored.
- This parameter is masked by default and the manipulated variable is not displayed.



Monitor

Control	Monitor range	Unit
Heating/cooling	0.0 to 105.0	%



See

- **Related Parameters**

Standard or Heating/Cooling (Initial Setting Level): Page 6-64

Parameter Mask Setting (Advanced Function Setting Level): Page 6-110

**Valve Opening Monitor****A Position-proportional Model must be used.**

Function

- This parameter is used to monitor the valve opening for position-proportional control.
- The valve opening can be monitored if a potentiometer is connected and motor calibration is executed.



Monitor

Control	Monitor range	Unit
Position-proportional control	-10.0 to 110.0	%



See

- **Related Parameters**

Motor Calibration (Initial Setting Level): Page 6-76

# 6-4 Program Setting Level

The Program Setting Level is used to set the set points, times, rates of rise, and other parameters for each program. The program to which to move is selected in the first parameter in the Program Setting Level (Display Program Selection).

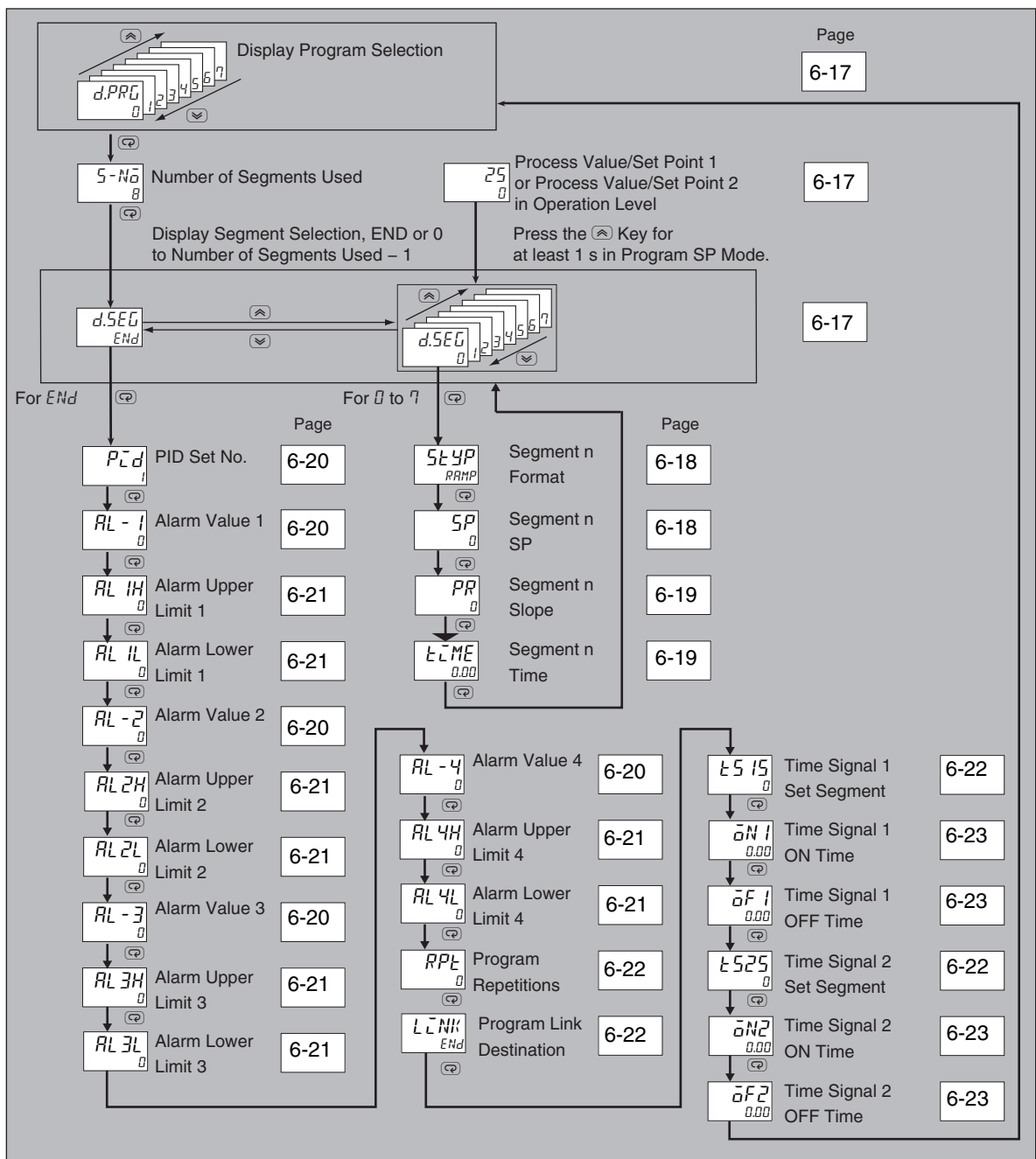
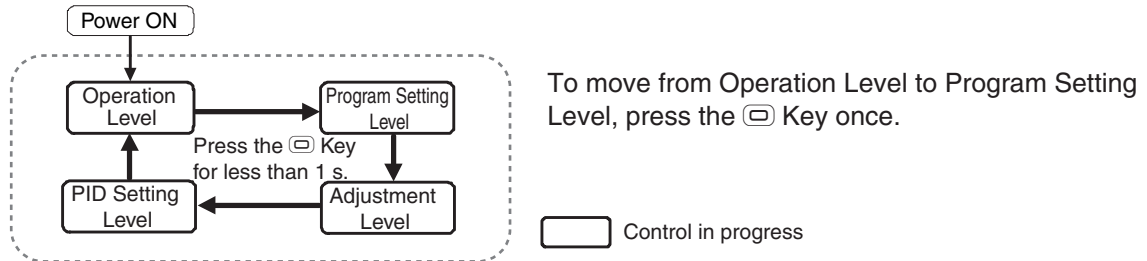



**d.PRG** Display Program Selection

- This parameter specifies the number of the program to be set.



Setting range	Unit	Default
0 to 7	---	*

\* Number of program currently used for control.



- Related Sections**  
4-7 Setting Programs (page 4-27)

**S-Nō** Number of Segments Used

- This parameter specifies the number of segments in the program.



Setting range	Unit	Default
1 to 32	---	8



- Related Sections**  
4-7 Setting Programs (page 4-27)

**d.SEG** Display Segment Selection

- This parameter specifies the number of the segment to set in the program.



Setting range	Unit	Default
END or 0 to Number of segments used - 1	---	END*

- \* If you move from the PV/SP display by pressing the Key for one second, the current segment number is displayed.



- Related Sections**  
4-7 Setting Programs (page 4-27)

**STEP** Segment n Format (n = 0 to 31)

The Display Segment Selection parameter must not be set to END. The Step Time/Rate of Rise Programming parameter must be set to Rate of Rise.



- This parameter sets the segment type for the specified segment number to ramp, soak, or step.



Setting range	Unit	Default
RAMP (ramp), SOAK (soak), or STEP (step)	---	RAMP



- Related Sections**

4-7 Setting Programs (page 4-27)

- Related Parameters**

Step Time/Rate of Rise Programming (Initial Setting Level): Page 6-59

**SP** Segment n SP (n = 0 to 31)

The Display Segment Selection parameter must not be set to END. The Step Time/Rate of Rise Programming parameter must be set to Step Time, or the Step Time/Rate of Rise Programming parameter must be set to Rate of Rise and the Segment Type parameter must be set to Ramp or Step.



- This parameter sets the SP for the specified segment number.
- For rate of rise programming, the target SP is set.



Setting range	Unit	Default
SP lower limit to SP upper limit	EU	0



- Related Sections**

4-7 Setting Programs (page 4-27)

- Related Parameters**

Step Time/Rate of Rise Programming (Initial Setting Level): Page 6-59

**PR** Segment n Slope (n = 0 to 31)

The Displayed Segment Selection parameter must not be set to END. The Step Time/Rate of Rise Programming parameter must be set to Rate of Rise. The Segment Type parameter must be set to Ramp.



Function

- This parameter sets the amount of change per the time unit of the slope for the specified segment number.
- If this parameter is set to 0, the segment will be a step segment.



Setting

Setting range	Unit	Default
0 to 9999	EU	0



See

- **Related Sections**

5-15 Program-related Functions (page 5-53)

- **Related Parameters**

Step Time/Rate of Rise Programming (Initial Setting Level): Page 6-59

Segment n Format (Program Setting Level): Page 6-18

**ELME** Segment n Time (n = 0 to 31)

The Display Segment Selection parameter must not be set to END. The Step Time/Rate of Rise Programming must be set to Step Time, or the Step Time/Rate of Rise Programming must be set to Rate of Rise and the Segment Type parameter must be set to Soak.



Function

- This parameter sets the segment time for the specified segment number.
- This parameter sets the soak segment time for rate of rise programming.



Setting

Setting range	Unit	Default
0.00 to 99.59	Hours and minutes, or minutes and seconds	0.00

- \* The unit is set in the Program Time Unit parameter. (The default is H-M (hours and minutes).)



See

- **Related Sections**

5-15 Program-related Functions (page 5-53)

- **Related Parameters**

Step Time/Rate of Rise Programming (Initial Setting Level): Page 6-59

Segment n Format (Program Setting Level): Page 6-18

**PID****PID Set No.****Control must be set to 2-PID control.**

Function

- This parameter sets the PID set number for the specified program number.
- If this parameter is set to 0, the automatic PID set selection function will automatically select the PID set number to be used in control according to the PV, DV, and SP.



Setting

Setting range	Unit	Default
0 to 8	---	1



See

### ● Related Sections

5-13 Using PID Sets (page 5-37)

**AL - 1** Alarm Value 1**AL - 2** Alarm Value 2**AL - 3** Alarm Value 3**AL - 4** Alarm Value 4**Alarms 1 to 4 must be assigned.**

**The alarm 1 to 4 type must not be set to 0, 1, 4, 5, or 12.**

This parameter is set to one of the input values (X) in the alarm type list (page 3-19).



Function

- These parameters set the alarm value for alarms 1 to 4 of the specified program number.
- For a temperature input, the decimal point is automatically set according to the selected sensor. For an analog input, the decimal point is set according to Decimal Point parameter setting.



Setting

Alarms Other Than an MV Alarm

Setting range	Unit	Default
-1999 to 9999	EU	0

MV Alarms

Setting range	Unit	Default
-199.9 to 999.9	%	0.0



See

### ● Related Parameters

Input Type (Initial Setting Level): Page 6-56

Scaling Upper Limit, Scaling Lower Limit, Decimal Point (Initial Setting Level): Page 6-57

Alarm 1 to 4 Type (Initial Setting Level): Page 6-66

Standby Sequence Reset (Advanced Function Setting Level): Page 6-83

Auxiliary Output 1 to 4 Open in Alarm (Advanced Function Setting Level): Page 6-84

Alarm 1 to 4 Latch (Advanced Function Setting Level): Page 6-89

**AL 1H** Alarm Upper Limit 1**AL 2H** Alarm Upper Limit 2**AL 3H** Alarm Upper Limit 3**AL 4H** Alarm Upper Limit 4**AL 1L** Alarm Lower Limit 1**AL 2L** Alarm Lower Limit 2**AL 3L** Alarm Lower Limit 3**AL 4L** Alarm Lower Limit 4

Alarms 1 to 4 must be assigned.  
The alarm 1 to 4 type must be set to 1, 4, or 5.

These parameters are used to set the alarm upper limits and alarm lower limits for alarms for which upper/lower limits have been selected in Alarm 1 Type to Alarm 4 Type (initial setting level).



- These parameters set the upper limits and lower limits for alarms 1 to 4 of the specified program number.
- For a temperature input, the decimal point is automatically set according to the selected sensor. For an analog input, the decimal point is set according to Decimal Point parameter setting.



Setting range	Unit	Default
-1999 to 9999	EU	0



#### ● Related Parameters

- Input Type (Initial Setting Level): Page 6-56
- Scaling Upper Limit, Scaling Lower Limit, Decimal Point (Initial Setting Level): Page 6-57
- Alarm 1 to 4 Type (Initial Setting Level): Page 6-66
- Alarm 1 to 4 Hysteresis (Initial Setting Level): Page 6-70
- Standby Sequence Reset (Advanced Function Setting Level): Page 6-83
- Auxiliary Output 1 to 4 Open in Alarm (Advanced Function Setting Level): Page 6-84
- Alarm 1 to 4 Latch (Advanced Function Setting Level): Page 6-89

**RPE** Program Repetitions

**LNK** Program Link Destination



Function

- The Program Repetitions parameter is used to repeatedly execute the same program for the specified number of repetitions. The actual number of executions will be the set value of this parameter plus one.
- The Program Link Destination Number parameter sets the link destination for the program. Operation will continue to the program with the number that is specified in this parameter after execution of the current program is completed.



Setting

Parameter	Setting range	Unit	Default
Program Repetitions	0 to 9,999	Repetitions	0
Program Link Destination	END or 0 to 7	---	END



See

- **Related Sections**  
5-15 Program-related Functions (page 5-53)

**t515** Time Signal 1 Set Segment

Outputs must be assigned to time signals 1 and 2.

**t525** Time Signal 2 Set Segment



Function

- These parameters set the segment numbers that will use time signals.
- Up to two outputs can be set for each program. There is one timing setting for each output.



Setting

Setting range	Unit	Default
0 to 31	---	0



See

- **Related Sections**  
5-15 Program-related Functions (page 5-53)

- **Related Parameters**

Time Signal 1 and 2 ON Time and Time Signal 1 and 2 OFF Time (Program Setting Level): Page 6-23

Control Output 1 and 2 Assignment (Advanced Function Setting Level): Page 6-97

Auxiliary Output 1 to 4 Assignment (Advanced Function Setting Level): Page 6-98

**$\bar{O}N1$**  Time Signal 1 ON Time

Outputs must be assigned to time signals 1 and 2.

**$\bar{O}N2$**  Time Signal 2 ON Time



- These parameters set the ON times for the time signals.



Setting range	Unit	Default
0.00 to 99.59	Hours and minutes, or minutes and seconds *	0.00

- \* The unit is set in the Program Time Unit parameter. (The default is H-M (hours and minutes).)



### ● Related Sections

5-15 Program-related Functions (page 5-53)

### ● Related Parameters

Time Signal 1 and 2 Set Segment (Program Setting Level): Page 6-22

Program Time Unit (Initial Setting Level): Page 6-58

**$\bar{O}F1$**  Time Signal 1 OFF Time

Outputs must be assigned to time signals 1 and 2.

**$\bar{O}F2$**  Time Signal 2 OFF Time



- These parameters set the OFF times for the time signals



Setting range	Unit	Default
0.00 to 99.59	Hours and minutes, or minutes and seconds *	0.00

- \* The unit is set in the Program Time Unit parameter. (The default is H-M (hours and minutes).)



### ● Related Sections

5-15 Program-related Functions (page 5-53)

### ● Related Parameters

Time Signal 1 and 2 Set Segment (Program Setting Level): Page 6-22

Program Time Unit (Initial Setting Level): Page 6-58

## 6-5 Adjustment Level

This level is for executing AT (auto-tuning) and other operations, and for set control parameters. This level provides the basic Controller parameters for PID control (proportional band, integral time, derivative time) and heating/cooling control.

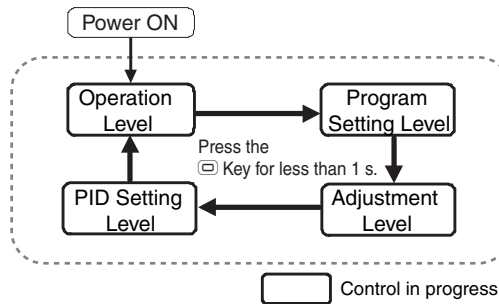

To move to the Adjustment Level from the Operation Level, press the [Key] twice.

- The following items are displayed for Controllers with CT Inputs: Heater current monitors, Leakage current monitors, HB alarm detection, and HS alarm detection.
- Adjustment Level parameters can be changed after setting the Operation/Adjustment Protect parameter to 0 or 1. Displays and changing levels are not possible if the Operation/Adjustment Protect parameter is set to 2 to 5. Protection is set in the Protect Level.



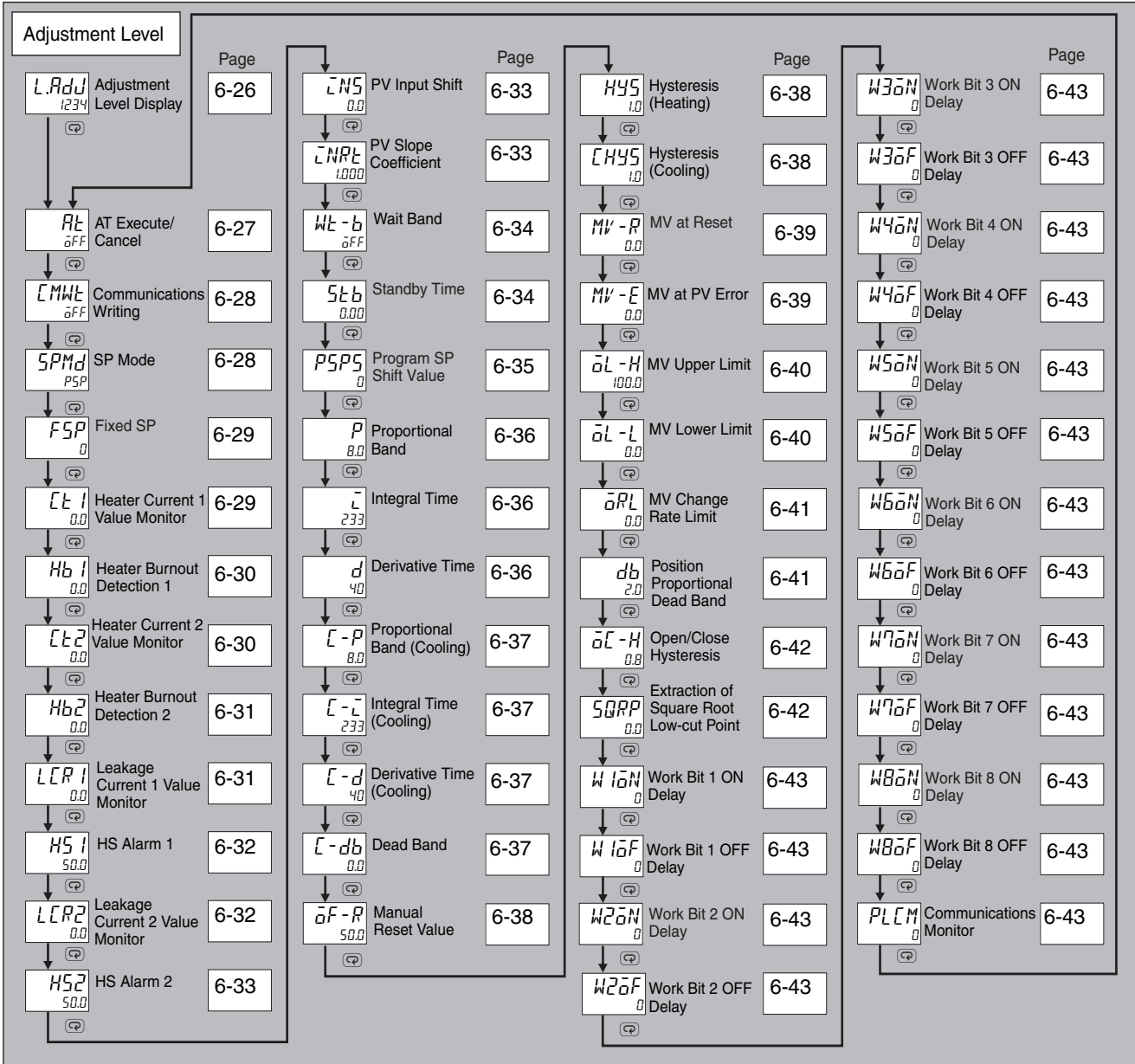

---

**L.Adj**    **Adjustment Level Display**

---

This parameter is displayed after moving to the Adjustment Level. The four numeric digits to identify the product code are displayed in the No. 2 display.

When a logic operation is set, a period "." will be displayed on the No. 2. display.



- This parameter indicates that the Adjustment Level has been entered.  
(The Adjustment Level parameter will not be displayed again even if the  Key is pressed in the Adjustment Level to scroll through the parameters.)

**At**      **AT Execute/Cancel**

**Control must be set to 2-PID control and the Reset Operation parameter must be set to fixed SP operation, or the Reset Operation parameter must be set to stop operation and the Controller must not be on standby or performing a reset.**

This parameter executes auto-tuning (AT).



- The MV is forcibly increased and decreased around the set point to find the characteristics of the control object. From the results, the PID constants are automatically set in the Proportional Band (P), Integral Time (I), and Derivative Time (D) parameters.
- AT can be set to 100% AT, 40% AT, All PID 100% AT, or All PID 40% AT. You can specify only 100% AT or All PID 100% AT during heating and cooling control or during position-proportional floating control.
- For heating/cooling control, select the tuning methods that is suitable for the cooling control characteristics in the Heating/Cooling Tuning Method parameter.
- If autotuning is performed with the default settings, the cooling PID constants (i.e., Proportional Band (Cooling), Integral Time (Cooling), and Derivative Time (Cooling) parameters) have the same values as the heating PID constants.



	Setting range	Default
ATA1:	All PID 40% AT Execute	OFF
ATA2:	All PID 100% AT Execute	
OFF:	AT Cancel	
AT-2:	100%AT Execute	
AT-1:	40%AT Execute	

- This parameter is normally  $\bar{OFF}$ ,  $At-2$ ,  $At-1$ ,  $AtA1$ , or  $AtA2$  to execute AT. Auto-tuning is not executed when control is stopped or during ON/OFF control.
- The TUNE indicator will light during autotuning.
- When AT execution ends, the parameter setting automatically returns to  $\bar{OFF}$ .



### ● Related Sections

- 4-9 Determining PID Constants (Autotuning and Manual Setting) (page 4-49)
- 5-14 Determining PID Constants for PID Sets (Autotuning for All PID Sets) (page 5-45)

### ● Related Parameters

- Proportional Band, Integral Time, and Derivative Time (Adjustment Level): Page 6-36
- Proportional Band (Cooling), Integral Time (Cooling), and Derivative Time (Cooling) (Adjustment Level): Page 6-37
- PID\*Proportional band, PID\*Integral time, PID\*Derivative time (PID setting level): Page 6-46
- PID ON/OFF (Initial Setting Level): Page 6-63
- Heating/Cooling Tuning Method (Advanced Function Setting Level): Page 6-103
- Close/Floating (Initial Setting Level): Page 6-75

**CMWE** Communications Writing

**Communications must be supported.  
The Event Input Assignment 1 to 6 parameters must not be set to enable/disable communications writing.**



- This parameter enables/disables writing of parameters to the E5□C-T from the host (personal computer) using communications.
- This parameter is not displayed if the Event Input Assignment 1 to 6 parameters are set to enable/disable communications writing.



Setting range		Default
ON:	Writing enabled	OFF
OFF:	Writing disabled	

- The Communications Writing parameter will be automatically turned ON if the Protocol Setting parameter is set to component communications, Host Link (FINS) communications, or the MC Protocol (Type 4).



- **Related Parameters**

Communications Setting Level: Page 6-111  
Protocol Setting, Communications Unit No., Communications Baud Rate,  
Communications Data Length, Communications Parity, and Communications Stop Bits

**SPMd** SP Mode

**The Reset Operation parameter must be set to stop control and the Event Input Assignment 1 to 6 parameters must not be set to change the SP mode.**



- This parameter sets the SP mode.
- In Program SP Mode, the SP from the set program will be used for control.
- In Fixed SP Mode, the fixed SP is used as the SP in control. Also, the FSP indicator will light.

Setting range	Default
PSP: Program SP or FSP: Fixed SP	PSP

## F5P Fixed SP



Function

- This parameter sets the SP used in Fixed SP Mode.



Setting

Setting range	Unit	Default
SP Lower Limit to SP Upper Limit	EU	0



See

### ● Related Parameters

SP Mode (Adjustment Level): Page 6-28

## ⌈⌋ 1 Heater Current 1 Value Monitor

HB and HS alarms must be supported.

The HB ON/OFF parameter must be set to ON.

This parameter measures the heater current from the CT input used for detecting heater burnout.



Function

This parameter measures and displays the heater current value.

- Heater burnout is not detected if the ON time for the control output for heating is 100 ms or less (30 ms or less if the control period is 0.1 or 0.2 s).



Monitor

Monitor range	Unit
0.0 to 55.0	A

- FFFF is displayed when 55.0 A is exceeded.
- If an alarm is output for the Heater Burnout Detection 1 parameter, the No. 1 display will flash the Heater Current 1 Value Monitor parameter.



See

### ● Related Parameters

Heater Burnout Detection 1 (Adjustment Level): Page 6-30

Heater Burnout Detection 2 (Adjustment Level): Page 6-31

HB ON/OFF (Advanced Function Setting Level): Page 6-84

Error Displays ⌈⌋ 1: Page A-13

**Hb 1****Heater Burnout Detection 1****HB and HS alarms must be supported.  
The HB ON/OFF parameter must be set to ON.**

This parameter sets the current for the heater burnout alarm to be output.



- The heater burnout alarm is output when the heater current value falls below the setting of this parameter.
- When the set value is 0.0, the heater burnout alarm output is turned OFF. When the set value is 50.0, the heater burnout alarm output is turned ON.



Setting range	Unit	Default
0.0 to 50.0	A	0.0



### ● Related Parameters

- Heater Current 1 Value Monitor (Adjustment Level): Page 6-29
- Heater Burnout Detection (Advanced Function Setting Level): Page 6-84
- Heater Burnout Latch (Advanced Function Setting Level): Page 6-85
- Heater Burnout Hysteresis (Advanced Function Setting Level): Page 6-85

**[[[2****Heater Current 2 Value Monitor****HB and HS alarms must be supported (two CTs).  
The HB ON/OFF parameter must be set to ON.**

This parameter measures the heater current from the CT input used for detecting heater burnout.



- This parameter measures and displays the heater current value.
- Heater burnout is not detected if the ON time for the control output for heating is 100 ms or less (30 ms or less if the control period is 0.1 or 0.2 s).



Monitor range	Unit
0.0 to 55.0	A

- *FFFF* is displayed when 55.0 A is exceeded.
- If an alarm is output for the Heater Burnout Detection 2 parameter, the No. 1 display will flash the Heater Current 2 Value Monitor parameter.



### ● Related Parameters

- Heater Burnout Detection 1 (Adjustment Level): Page 6-30
- Heater Burnout Detection 2 (Adjustment Level): Page 6-31
- Error Displays **[[[2**: Page A-13

**Hb2****Heater Burnout Detection 2**

**HB and HS alarms must be supported (two CTs).  
The HB ON/OFF parameter must be set to ON.**

This parameter sets the current for the heater burnout alarm to be output.



Function

- The heater burnout alarm is output when the heater current value falls below the setting of this parameter.
- When the set value is 0.0, the heater burnout alarm output is turned OFF. When the set value is 50.0, the heater burnout alarm output is turned ON.



Setting

Setting range	Unit	Default
0.0 to 50.0	A	0.0



See

● **Related Parameters**

Heater Current 2 Value Monitor (Adjustment Level): Page 6-30

HB ON/OFF (Advanced Function Setting Level): Page 6-84

Heater Burnout Latch (Advanced Function Setting Level): Page 6-85

Heater Burnout Hysteresis (Advanced Function Setting Level): Page 6-85

**LER1****Leakage Current 1 Monitor**

**HB and HS alarms must be supported.  
The HS Alarm Use parameter must be set to ON.**

This parameter measures the heater current from the CT input used for detecting SSR short-circuits.



Function

This parameter measures and displays the heater current when the heater is OFF.

- The HS alarm is not detected if the OFF time for the control output for heating is 100 ms or less (35 ms or less if the control period is 0.1 or 0.2 s).



Monitor

Monitor range	Unit
0.0 to 55.0	A

- *FFFF* is displayed when 55.0 A is exceeded.
- If an alarm is output for the HS Alarm 1 parameter, the No. 1 display will flash the Leakage Current 1 Monitor parameter.



See

● **Related Parameters**

HS Alarm 1 (Adjustment Level): Page 6-32

HS Alarm 2 (Adjustment Level): Page 6-33

HS Alarm Use (Advanced Function Setting Level): Page 6-94

Error Displays *LER1*: Page A-13

**HS 1****HS Alarm 1**

**HB and HS alarms must be supported.  
The HS Alarm Use parameter must be set to ON.**

This parameter sets the current for the HS alarm to be output.



- An HS alarm is output when the leakage current value exceeds the setting of this parameter.
- When the set value is 50.0, the HS alarm output is turned OFF. When the set value is 0.0, the HS alarm output is turned ON.



Setting range	Unit	Default
0.0 to 50.0	A	50.0



### ● Related Parameters

- Leakage Current 1 Monitor (Adjustment Level): Page 6-31
- HS Alarm (Advanced Function Setting Level): Page 6-94
- HS Alarm Latch (Advanced Function Setting Level): Page 6-94
- HS Alarm Hysteresis (Advanced Function Setting Level): Page 6-95

**LCR2****Leakage Current 2 Monitor**

**HB and HS alarms must be supported (two CTs).  
The HS Alarm Use parameter must be set to ON.**

This parameter measures the heater current from the CT input used for detecting SSR short-circuits.



- This parameter measures and displays the heater current when the heater is OFF.
- The HS alarm is not detected if the OFF time for the control output for heating is 100 ms or less (35 ms or less if the control period is 0.1 or 0.2 s).



Monitor range	Unit
0.0 to 55.0	A

- *FFFF* is displayed when 55.0 A is exceeded.
- If an alarm is output for the HS Alarm 2 parameter, the No. 1 display will flash the Leakage Current 2 Monitor parameter.



### ● Related Parameters

- HS Alarm 1 (Adjustment Level): Page 6-32
- HS Alarm 2 (Adjustment Level): Page 6-33
- HS Alarm Use (Advanced Function Setting Level): Page 6-94
- Error Displays *LCR2*: Page A-13



**H52** HS Alarm 2

HB and HS alarms must be supported (two CTs).  
The HS Alarm Use parameter must be set to ON.

This parameter sets the current for the HS alarm to be output.



Function

- An HS alarm is output when the leakage current value exceeds the setting of this parameter.
- When the set value is 50.0, the HS alarm output is turned OFF. When the set value is 0.0, the HS alarm output is turned ON.



Setting

Setting range	Unit	Default
0.0 to 50.0	A	50.0



See

● **Related Parameters**

- Leakage Current 2 Monitor (Adjustment Level): Page 6-32  
 HS Alarm Use (Advanced Function Setting Level): Page 6-94  
 HS Alarm Latch (Advanced Function Setting Level): Page 6-94  
 HS Alarm Hysteresis (Advanced Function Setting Level): Page 6-95

**LNS** PV Input Shift

Function

Sometimes an error occurs between the process value and the actual temperature. To offset this, a compensated value can be obtained by adding an input shift value to the input. The compensated value is displayed as the process value and used for control. The entire input range is shifted by a fixed rate. If the input shift value is set to  $-1^{\circ}\text{C}$ , control will be performed for a value  $1^{\circ}\text{C}$  lower than the measured temperature.



Setting

Setting range	Unit	Default
Temperature input: $-199.9$ to $999.9$	$^{\circ}\text{C}$ or $^{\circ}\text{F}$	0.0
Analog input: $-1,999$ to $9,999^*$	EU	0

\* The decimal point position depends on the Decimal Point parameter setting.



See

● **Related Parameters**

- Input Type (Initial Setting Level): Page 6-56

**LNRL** PV Slope Coefficient

Function

This parameter sets a factor to apply to the input to compensate the process value. The resulting value is displayed as the process value and used in control.



Setting

Setting range	Default
0.001 to 9.999	1.000

**Wt-b** Wait Band

- This parameter sets the band for the wait operation as a deviation from the SP.
- The wait operation is not performed if the wait band is set to 0.



Setting range	Unit	Default
Temperature input: OFF, or 0.1 to 999.9	°C or °F	OFF
Analog input: OFF, or 0.01 to 99.99	%FS	



- **Related Parameters**

5-15 Program-related Functions (page 5-53)

**Stb** Standby Time

- This parameter is used to set the time from when the run command is executed until the program starts operation.



Setting range	Unit	Default
0.00 to 99.59 (hours.minutes)	Hours and minutes, or days and hours*	0.00
0.00 to 99.23 (days.hours)		

\* The unit is set in the Standby Time Unit parameter. (The default is H-M (hours and minutes).)



- **Related Sections**

5-15 Program-related Functions (page 5-53)

- **Related Parameters**

Standby Time Unit (Advanced Function Setting Level): Page 6-82

## PSP5 Program SP Shift Value



Function

- This parameter performs a fixed-rate compensation (1-point compensation) for the program SP (PSP).
- This parameter is masked by default and not displayed.



Setting

Setting range	Unit	Default
-1999 to 9999	EU	0



See

### ● Related Sections

5-15 Program-related Functions (page 5-53)

### ● Related Parameters

Parameter Mask Setting (Advanced Function Setting Level): Page 6-110

**P** Proportional Band

**I** Integral Time

The control must be set to 2-PID control.

**D** Derivative Time

These parameters set the PID constants. If auto-tuning is executed, these parameters are set automatically.



**P** Refers to control in which the MV is proportional to the deviation (control error).  
action:

**I** Refers to a control action that is proportional to the time integral of the deviation.  
action: With proportional control, there is normally an offset (control error). Proportional action is thus used in combination with integral action. As time passes, this control error disappears, and the control temperature (process value) comes to agree with the set point.

**D** Refers to a control action that is proportional to the time derivative of the control error. The proportional control and integral control correct for errors in the control result, and thus the control system is late in responding to sudden changes in temperature. The derivative action increases the MV in proportion to the slope of the change in the temperature as a corrective action.

- The set values are saved in the Proportional Band, Integral Time, and Derivative Time parameters for the selected PID set.



Parameter	Setting range		Unit	Default	
Proportional Band	Temperature input	0.1 to 999.9	°C or °F	8.0	
	Analog input		%FS	10.0	
Integral/ Derivative Time Unit of	1 s	Standard, heating/cooling, or close position-proportional control	0 to 9999	Seconds	233
		Floating position-proportional control	1 to 9999		
	0.1 s	Standard, heating/cooling, or close position-proportional control	0.0 to 999.9	Seconds	233.0
		Floating position-proportional control	0.1 to 999.9		
Derivative Time *	Integral/Derivative Time Unit of 1 s	0 to 9999	Seconds	40	
	Integral/Derivative Time Unit of 0.1 s	0.0 to 999.9	Seconds	40.0	

\* The unit is determined by the setting of the Integral/Derivative Time Unit parameter. The Proportional Band, Integral Time, and Derivative Time parameters are initialized if the Integral/Derivative Time Unit parameter is changed.



### ● Related Parameters

AT Execute/Cancel (Adjustment Level): Page 6-27

Integral/Derivative Time Unit (Advanced Function Setting Level): Page 6-86

PID\*Proportional band, PID\*Integral time, PID\*Derivative time (PID setting level): Page 6-46

**[ -P**      **Proportional Band (Cooling)**

**[ -I**      **Integral Time (Cooling)**

**The control must be set to heating/cooling control and 2-PID control.**

**[ -d**      **Derivative Time (Cooling)**



Function

These parameters set the PID constants for cooling control.

These parameters are automatically set according to the Heating/Cooling Tuning Method parameter when auto-tuning is executed.

- The set values are saved in the Proportional Band, Integral Time, and Derivative Time parameters for the selected PID set.



Setting

Parameter	Setting range	Unit	Default
Proportional Band (Cooling)	Temperature input	0.1 to 999.9	°C or °F
	Analog input		%FS
Integral Time (Cooling) *	Integral/Derivative Time Unit of 1 s	0 to 9999	Seconds
	Integral/Derivative Time Unit of 0.1 s	0.0 to 999.9	Seconds
Derivative Time (Cooling)*	Integral/Derivative Time Unit of 1 s	0 to 9999	Seconds
	Integral/Derivative Time Unit of 0.1 s	0.0 to 999.9	Seconds

\* The unit is determined by the setting of the Integral/Derivative Time Unit parameter. The Proportional Band (Cooling), Integral Time (Cooling), and Derivative Time (Cooling) parameters are initialized if the Integral/Derivative Time Unit parameter is changed.



See

#### ● Related Parameters

AT Execute/Cancel (Adjustment Level): Page 6-27

Integral/Derivative Time Unit (Advanced Function Setting Level): Page 6-86

PID\*Proportional Band, PID\*Integral Time, PID\*Derivative Time (PID Setting Level): Page 6-46

**[ -db**      **Dead Band**

**The control must be set to heating/cooling control.**

This parameter sets the output dead band width for heating/cooling control. A negative setting sets an overlapping band.



Function

- This parameter sets an area in which the control output is 0 centering around the set point for a heating/cooling control.



Setting

	Setting range	Unit	Default
Temperature input	-199.9 to 999.9	°C or °F	0.0
Analog input	-19.99 to 99.99	%FS	0.00



See

#### ● Related Parameters

PID \* Dead Band (PID Setting Level): Page 6-47

**OF-R****Manual Reset Value**

The control must be standard control and 2-PID control.  
The Integral Time parameter must be set to 0.



- This parameter sets the required manipulated variable to remove offset during stabilization of P or PD control.



Setting range	Unit	Default
0.0 to 100.0	%	50.0



### ● Related Parameters

- Integral Time (Adjustment Level): Page 6-36
- PID \* Integral Time (PID Setting Level): Page 6-47
- PID \* Manual Reset Value (PID Setting Level): Page 6-48
- PID ON/OFF (Initial Setting Level): Page 6-63

**HYS**  
**[HYS****Hysteresis (Heating)**  
**Hysteresis (Cooling)**

The control must be ON/OFF control.  
For the Hysteresis (Cooling) parameter, the control must be heating/cooling control.

This parameter sets the hysteresis for ensuring stable operation at the ON/OFF switching point.



- For standard control, use the Hysteresis (Heating) parameter. The Hysteresis (Cooling) parameter cannot be used.
- For heating/cooling control, the hysteresis can be set independently for heating/cooling. The Hysteresis (Heating) parameter is used for the heating side, and the Hysteresis (Cooling) parameter is used for the cooling side.



Parameter name	Setting range	Unit	Default
Hysteresis (Heating)	Temperature input	0.1 to 999.9	°C or °F
	Analog input	0.01 to 99.99	%FS
Hysteresis (Cooling)	Temperature input	0.1 to 999.9	°C or °F
	Analog input	0.01 to 99.99	%FS



### ● Related Parameters

- PID ON/OFF (Initial Setting Level): Page 6-63
- Standard or Heating/Cooling (Initial Setting Level): Page 6-64

**MV - R** MV at Reset

The control must be set to 2-PID control and the Reset Operation parameter must be set to stop control.



Function

- This parameter sets the MV when switching between run status and reset status during Run/Reset control. However, if the reset operation is set to a fixed SP operation, the MV at reset is not used.
- The parameter is masked by default and not displayed.



Setting

Control method	Setting range	Unit	Default
Standard Position proportional (Closed and direct setting of position proportional MV is ON.)	-5.0 to 105.0	%	0.0
Heating/cooling			
Position Proportional (Floating or direct setting of position proportional MV is OFF.)	CLOS, HOLD, or OPEN	None	HOLD



See

- **Related Parameters**

Run/Reset (Operation Level): Page 6-14

Parameter Mask Setting (Advanced Function Setting Level): Page 6-110

**MV - E** MV at PV Error

The control must be set to 2-PID control or a Position-proportional Model must be used.



Function

- This parameter sets the MV to use when an input error occurs.
- This parameter is masked by default and not displayed.



Setting

Control method	Setting range	Unit	Default
Standard Position proportional (Closed and direct setting of position proportional MV is ON.)	-5.0 to 105.0	%	0.0
Heating/cooling			
Position Proportional (Floating or direct setting of position proportional MV is OFF.)	CLOS, HOLD, or OPEN	None	HOLD



See

- **Related Parameters**

Close/Floating (Initial Setting Level): Page 6-75

Direct Setting of Position Proportional MV (Advanced Function Setting Level): Page 6-102

Parameter Mask Setting (Advanced Function Setting Level): Page 6-110

$\bar{O}L-H$  MV Upper Limit

The control must be set to 2-PID control.  
A Position-proportional Model must be set to close control.

$\bar{O}L-L$  MV Lower Limit



Function

- The MV Upper Limit and MV Lower Limit parameters set the upper and lower limits of the manipulated variable. When the calculated manipulated variable exceeds the upper or lower limit value, the upper or lower limit value will be the output level.
- The set value is saved in the MV Upper Limit and MV Lower Limit parameters for the current PID set.



Setting

- MV Upper Limit

Control method	Setting range	Unit	Default
Standard control	MV lower limit + 0.1 to 105.0	%	100.0
Close position-proportional control			
Heating/cooling control	0.0 to 105.0		

- MV Lower Limit

The MV for the cooling control output during heating/cooling control is expressed as a negative value.

Control method	Setting range	Unit	Default
Standard control	-5.0 to MV upper limit - 0.1	%	0.0
Close position-proportional control			
Heating/cooling control	-105.0 to 0.0		-100.0



See

● **Related Parameters**

- PID ON/OFF (Initial Setting Level): Page 6-63
- Close/Floating (Initial Setting Level): Page 6-75
- PID \* MV Upper Limit and PID \* MV Lower Limit (PID Setting Level): Page 6-48



**oRL****MV Change Rate Limit****2-PID control must be used.**

- The MV change rate limit sets the maximum allowable width of change in the MV per second. (For Position-proportional Models, the maximum valve opening per second is set.) If the change in the MV exceeds this setting, the MV will be changed by the MV change rate limit until the calculated value is reached. If the limit is set to 0.0, this function will be disabled.
- The MV Change Rate Limit parameter will not operate in the following situations.
  - In Manual Mode
  - During AT execution
  - During ON/OFF control
  - While resetting (during MV output when resetting)
  - During MV output when error occurs



Setting range	Unit	Default
0.0 to 100.0	%/s	0.0



- **Related Parameters**

Proportional Band (Adjustment Level): Page 6-36

**db****Position Proportional Dead Band****A Position-proportional Model must be used.**

- When the difference between the MV and the valve opening is within the value that is set for the Position Proportional Dead Band, opening or closing the valve will be stopped to prevent the valve from deteriorating.



Setting range	Unit	Default
Close control: 0.1 to 10.0	%	4.0
Floating control: 0.1 to 10.0	%	2.0



- **Related Parameters**

Open/Close Hysteresis (Adjustment Level): Page 6-42

**OC-H****Open/Close Hysteresis****A Position-proportional Model must be used.**

- The Open/Close Hysteresis parameter is used to shift the ON and OFF points for the open output and close output to prevent output chattering.



Setting range	Unit	Default
0.1 to 20.0	%	0.8



- Related Parameters**

Position Proportional Dead Band (Adjustment Level): Page 6-41

**SQRP****Extraction of Square Root Low-cut Point****The input type must be an analog input, and the Extraction of Square Root Enable parameter must be set to ON.**

- This parameter sets the extraction of square root low-cut point used for the inputs. The data after extracting the square root is shown below.
- The low-cut point is used for extracting the square root for flowrate sensors.

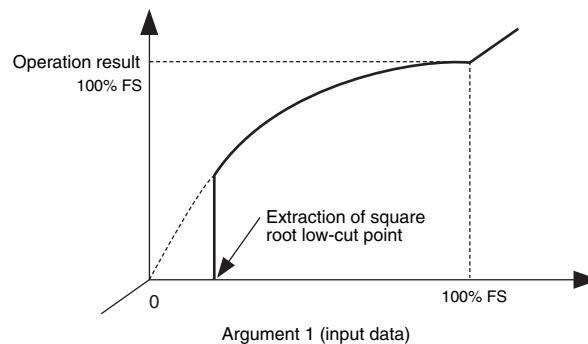

Setting range	Unit	Default
0.0 to 100.0	%	0.0



- Related Parameters**

Extraction of Square Root Enable (Initial Setting Level): Page 6-78

**W1 to B $\bar{O}N$**  Work Bit 1 to 8 ON Delay  
**W1 to B $\bar{O}F$**  Work Bit 1 to 8 OFF Delay

The work bit operation type must not be set to OFF.



Function

- ON Delay  
When the results of a work bit logic operation is ON, the work bit is turned ON after the time specified in the parameter elapses.
- OFF Delay  
When the results of a work bit logic operation is OFF, the work bit is turned OFF after the time specified in the parameter elapses.



Setting

Setting range	Unit	Default
0 to 9999	Seconds	0



See

### ● Related Parameters

Auxiliary Output 1 to 4 Assignment (Advanced Function Setting Level): Page 6-98

**PLCM** Communications Monitor

Communications must be supported.  
The Protocol Setting parameter must be set to Host Link (FINS) or the MC Protocol.



Function

- The Communications Monitor parameter displays the communications cycle time of the E5□C-T.
- If communications are not possible with the PLC,  $\overline{LERR}$  is displayed. When communications are restored, the cycle time is displayed again.



Setting

Monitoring range	Default
Normal: 0 to 9999 ms, If 9999 ms is exceeded: $\overline{LERR}$ Error: $\overline{LERR}$	---

Also refer to the *E5□C-T Digital Controllers Communications Manual* (Cat. No. H186) for information on communications.

# 6-6 PID Setting Level

The PID setting level is used to make settings such as PID values for each PID set and MV limit values. Move to a particular PID set from the Display PID Set Selection parameter, which is displayed first in the PID setting level.

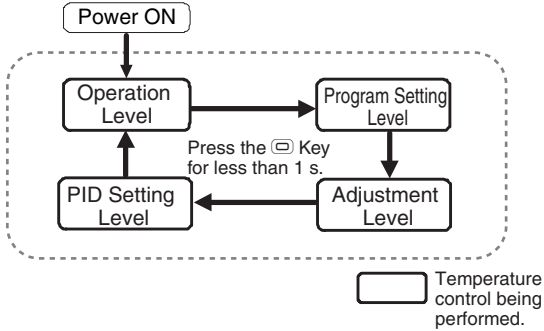

To move to the PID Setting Level from the Operation Level, press the [Enter] Key three times.

**PID Setting Level**

**Display PID Selection**

PID1:  $d.P \bar{L} d$  | PID2:  $\bar{L} d$  | PID3:  $\bar{L} d$  | PID4:  $\bar{L} d$  | PID5:  $\bar{L} d$  | PID6:  $\bar{L} d$  | PID7:  $\bar{L} d$  | PID8:  $\bar{L} d$

Page

**6-44**

<p><math>I.P</math> 8.0</p> <p><math>I.L</math> 233</p> <p><math>I.d</math> 4.0</p> <p><math>I.C-P</math> 8.0</p> <p><math>I.C-L</math> 233</p> <p><math>I.C-d</math> 4.0</p> <p><math>I.Cdb</math> 0.0</p> <p><math>I.oFR</math> 50.0</p> <p><math>I.oLH</math> 100.0</p> <p><math>I.oLL</math> 0.0</p> <p><math>I.AUT</math> 1320</p> <p><math>I.LbA</math> 0</p>	<p><math>PID 8</math> Proportional Band</p> <p><math>PID 8</math> Integral Time</p> <p><math>PID 8</math> Derivative Time</p> <p><math>PID 8</math> Proportional Band (Cooling)</p> <p><math>PID 8</math> Integral Time (Cooling)</p> <p><math>PID 8</math> Derivative Time (Cooling)</p> <p><math>PID 8</math> Dead Band</p> <p><math>PID 8</math> Manual Reset Value</p> <p><math>PID 8</math> MV Upper Limit</p> <p><math>PID 8</math> MV Lower Limit</p> <p><math>PID 8</math> Automatic Selection Range Upper Limit</p> <p><math>PID 8</math> LBA Detection Time</p>
<p>6-46</p> <p>6-46</p> <p>6-46</p> <p>6-47</p> <p>6-47</p> <p>6-47</p> <p>6-47</p> <p>6-48</p> <p>6-48</p> <p>6-48</p> <p>6-49</p> <p>6-49</p>	

## d.P<sub>L</sub>d Display PID Selection

This parameter is used to select the PID set for making the display settings.





Function

- This parameter selects the PID set for which the display settings are to be made.
- You can use up to eight sets of the following values by registering them for PID set numbers 1 to 8: PID constants, MV upper/lower limits, dead bands, manual reset values, automatic selection range upper limits, and LBA detection times.



Setting

Setting range	Default
1 to 8	*

- \* The current PID set will be displayed. If you use the  and  Keys to change the PID set, the monitor function will be canceled.



See

### ● Related Parameters

PID Set No. (Program Setting Level): Page 6-20

<b>*P</b>	<b>PID * Proportional Band</b>	
<b>*I</b>	<b>PID * Integral Time</b>	<b>2-PID control must be used.</b>
<b>*d</b>	<b>PID * Derivative Time (*: 1 to 8)</b>	

These parameters set the PID constants for each PID set. If auto-tuning is executed, these parameters are set automatically.



**P action:** For the P action, the MV is proportional to the derivative.

**I action:** For the I action, an output is produced that is proportional to the time integral of the derivative. An offset normally occurs with the proportional action, so the proportional action is used in combination with the integral action. As time passes, this offset disappears and the control temperature comes to match the set point.

**D action:** For the D action, an output is produced that is proportional to the time derivative of the input. Because the proportional action and integral action correct for errors in the control result, the control system will be slow to respond to sudden changes in temperature. The derivative action performs a corrective action by increasing the MV in proportion to the slope of the temperature change.



Parameter	Setting range		Unit	Default	
Proportional Band	Temperature input		0.1 to 999.9	°C or °F	8.0
	Analog input			%FS	10.0
Integral Time*	Integral/Derivative Time Unit of 1 s	Standard, heating/cooling, position proportional (closed)	0 to 9,999	Seconds	233
		Position proportional (floating)	1 to 9,999		
	Integral/Derivative Time Unit of 0.1 s	Standard, heating/cooling, position proportional (closed)	0.0 to 999.9	Seconds	233.0
		Position proportional (floating)	0.1 to 999.9		
Derivative Time*	Integral/Derivative Time Unit of 1 s		0 to 9,999	Seconds	40
	Integral/Derivative Time Unit of 0.1 s		0.0 to 999.9	Seconds	40.0

\* The unit is determined by the setting of the Integral/Derivative Time Unit parameter. The Proportional Band, Integral Time, and Derivative Time parameters are initialized if the Integral/Derivative Time Unit parameter is changed.



### ● Related Parameters

AT Execute/Cancel (Adjustment Level): Page 6-27

Integral/Derivative Time Unit (Advanced Function Setting Level): Page 6-86

\*.[-P PID \* Proportional Band (Cooling)

\*.[-I PID \* Integral Time (Cooling)

The control must be set to heating/cooling control and 2-PID control.

\*.[-d PID \* Derivative Time (Cooling)  
(\*: 1 to 8)

These parameters set the PID constants for each PID set number. If auto-tuning is executed, these parameters are set automatically.



These parameters set the PID constants for cooling control.

These parameters are automatically set according to the Heating/Cooling Tuning Method parameter when auto-tuning is executed.



Parameter	Setting range	Unit	Default
Proportional Band (Cooling)	Temperature input	0.1 to 999.9	°C or °F
	Analog input		%FS
Integral Time (Cooling)*	Integral/Derivative Time Unit of 1 s	0 to 9,999	Seconds
	Integral/Derivative Time Unit of 0.1 s	0.0 to 999.9	Seconds
Derivative Time (Cooling)*	Integral/Derivative Time Unit of 1 s	0 to 9,999	Seconds
	Integral/Derivative Time Unit of 0.1 s	0.0 to 999.9	Seconds

\* The unit is determined by the setting of the Integral/Derivative Time Unit parameter. The Proportional Band (Cooling), Integral Time (Cooling), and Derivative Time (Cooling) parameters are initialized if the Integral/Derivative Time Unit parameter is changed.



### ● Related Parameters

AT Execute/Cancel (Adjustment Level): Page 6-27

Integral/Derivative Time Unit (Advanced Function Setting Level): Page 6-86

\*.[-db PID \* Dead Band (\*: 1 to 8)

The control method must be set to heating/cooling control.

These parameters set the output dead band width for heating/cooling control for each PID set number. A negative setting sets an overlapping band.



- These parameters set an area in which the control output is 0 centering around the set point for a heating/cooling control.



Setting range	Unit	Default
Temperature input	-199.9 to 999.9	°C or °F
Analog input	-19.99 to 99.99	%FS

**\*.ΔFR**

**PID \* Manual Reset Value**  
(\*: 1 to 8)

The control method must be set to standard control and 2-PID control and the integral time must be set to 0.



Function

- These parameters set the required manipulated variable to remove the offset during settling in P or PD control for each PID set number.



Setting

Setting range	Unit	Default
0.0 to 100.0	%	50.0



See

● **Related Parameters**

Integral Time (Adjustment Level): Page 6-36  
PID ON/OFF (Initial Setting Level): Page 6-63

**\*.ΔLH**

**PID \* MV Upper Limit**

**2-PID control must be used.**

**\*.ΔLL**

**PID \* MV Lower Limit**

**Closed control must be used (for position proportional models).**

(\*: 1 to 8)

These parameters set the MV upper and lower limits for each PID set.



Function

- The MV Upper Limit and MV Lower Limit parameters set the upper and lower limits of the manipulated variable. When the calculated manipulated variable exceeds the upper or lower limit value, the upper or lower limit value will be the output level.
- MV limits do not operate when floating control is used with models that support position-proportional control, so these parameters are disabled.



Setting

• **MV Upper Limit**

The setting range depends on whether standard, position-proportional (closed) control, or heating/cooling control is used. In addition, the cooling MV during heating/cooling control is expressed as a negative value.

Control method	Setting range	Unit	Default
Standard	MV lower limit + 0.1 to 105.0	%	100.0
Position proportional (closed)			
Heating/cooling	0.0 to 105.0		

• **MV Lower Limit**

The setting range depends on whether standard, position-proportional (closed) control, or heating/cooling control is used. In addition, the cooling MV during heating/cooling control is expressed as a negative value.

Control method	Setting range	Unit	Default
Standard	-5.0 to MV upper limit - 0.1	%	0.0
Position proportional (closed)			
Heating/cooling	-105.0 to 0.0		-100.0



See

● **Related Parameters**

PID ON/OFF (Initial Setting Level): Page 6-63  
Close/Floating (Initial Setting Level): Page 6-75



**\*.AUT** PID \* Automatic Selection Range Upper Limit (\*: 1 to 8) **2-PID control must be used.**

These parameters set the upper limit for each PID set when PID sets are selected automatically.



Function

- These parameters are used to set the automatic selection range upper limits for PID sets 1 to 8.
- The sensor setting range for PID set 8 is the upper limit of the specified range for a temperature input and 105.0% for an analog input. This parameter cannot be set.
- These values apply to the PV (process value), DV (deviation), or SP (set point) set in the PID Set Automatic Selection Data parameter. The default setting is PV
- These settings are used to automatically calculate set points when tuning is performed with the All PID AT operation.



Setting

Setting range	Unit	Default
Temperature input: -1,999 to 9,999	EU	1320
Analog input: -5.0 to 105.0	%	105.0



See

#### ● Related Parameters

- Integral Time (Adjustment Level): Page 6-36
- PID ON/OFF (Initial Setting Level): Page 6-63

**\*.LBA** PID \* LBA Detection Time (\*: 1 to 8) **2-PID control must be used.  
The alarm 1 type must be 12 (LBA).**

These parameters set whether the LBA function is to be enabled or disabled and sets the time interval for detection, for each PID set.



Function

- These parameters set the time interval for detecting the LBA.
- Setting 0 disables the LBA function.
- For ON/OFF control, make the setting in the LBA Detection Time parameter in the advanced function setting level.



Setting

Setting range	Unit	Default
0 to 9999	s	0



See

#### ● Related Parameters

- Alarm 1 Type (initial setting level): Page 6-66
- LBA Level (Advanced Function Setting Level): Page 6-96
- LBA Band (Advanced Function Setting Level): Page 6-96

## 6-7 Monitor/Setting Item Level

Monitor/setting items can be displayed by means of the PF key when the PF Setting parameter (Advanced Function Setting Level) is set to PFDP: Monitor/Setting Item.

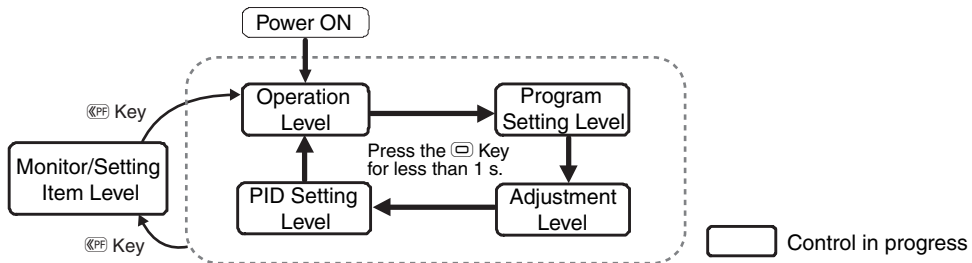

To move from any of the levels within the dotted line to the Monitor/Setting Item Level, press the **PF** Key.

**PFd 1 to 5** Monitor/Setting Item Display 1 to 5

The PF Setting parameter must be set to PFDP, and the Monitor/Setting Item 1 to 5 parameters must not be set to OFF.

- When the PF Key is set to display monitor/setting items, pressing the PF Key will display in order the contents of the Monitor/Setting Item 1 to 5 parameters. The contents of these parameters are shown in the following table. For the setting (monitor) ranges, refer to the applicable parameters.

Set value	Setting	Remarks	
		Monitor/Setting	Display
0	Disabled	---	---
1	PV/SP/Program No. Monitor and Segment No. Monitor	Can be set. (SP) <sup>*1</sup>	---
2	PV/SP/MV (Heating) (Valve Opening for Position-proportional Models)	Can be set. (SP) <sup>*1</sup>	---
3	PV/SP/MV (Cooling)	Can be set. (SP) <sup>*1</sup>	---
4	PV/SP/Remaining Segment Time	Can be set. (SP) <sup>*1</sup>	---
5	Program No.	Can be set.	PRG
6	Segment No. Monitor	Cannot be set.	SEG
7	Remaining Standby Time Monitor	Cannot be set.	StbM
8	Elapsed Program Time Monitor	Cannot be set.	PRGt
9	Remaining Program Time Monitor	Cannot be set.	PRGR
10	Elapsed Segment Time Monitor	Cannot be set.	SEGt
11	Remaining Segment Time Monitor	Cannot be set.	SEGR
12	Program Execution Repetitions Monitor	Cannot be set.	RPLM
13	Proportional band	Can be set.	$p^{*2}$
14	Integral time	Can be set.	$i^{*2}$
15	Derivative time	Can be set.	$d^{*2}$
16	Proportional Band (Cooling)	Can be set.	$[ - p^{*2}$
17	Integral Time (Cooling)	Can be set.	$[ - i^{*2}$
18	Derivative Time (Cooling)	Can be set.	$[ - d^{*2}$
19	Alarm value 1 <sup>*3</sup>	Can be set.	RL - 1
20	Alarm value upper limit 1 <sup>*3</sup>	Can be set.	RL 1H
21	Alarm value lower limit 1 <sup>*3</sup>	Can be set.	RL 1L
22	Alarm value 2 <sup>*3</sup>	Can be set.	RL - 2
23	Alarm value upper limit 2 <sup>*3</sup>	Can be set.	RL 2H
24	Alarm value lower limit 2 <sup>*3</sup>	Can be set.	RL 2L
25	Alarm value 3 <sup>*3</sup>	Can be set.	RL - 3
26	Alarm value upper limit 3 <sup>*3</sup>	Can be set.	RL 3H
27	Alarm value lower limit 3 <sup>*3</sup>	Can be set.	RL 3L
28	Alarm value 4 <sup>*3</sup>	Can be set.	RL - 4
29	Alarm value upper limit 4 <sup>*3</sup>	Can be set.	RL 4H
30	Alarm value lower limit 4 <sup>*3</sup>	Can be set.	RL 4L

\*1 With the E5CC-T, only the PV and SP can be displayed. The SP can be selected only in Fixed SP Mode.

\*2 The setting for the currently selected PID set number is displayed.

\*3 The setting for the currently selected program number is displayed.

## 6-8 Manual Control Level

If you change to Manual Mode, the Manual MV parameter will be displayed and the displayed value will be output as the MV.

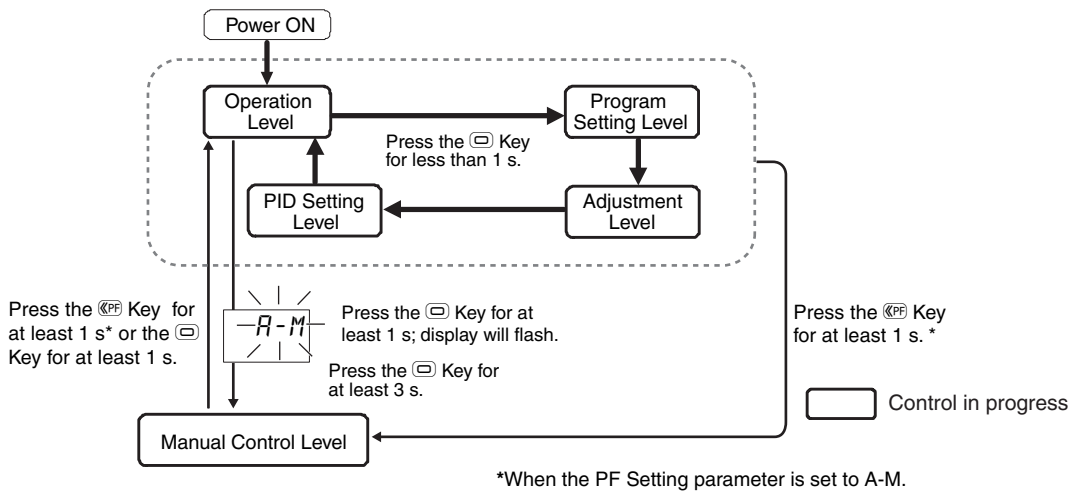

To move from the operation level to the manual control level, hold the Key down for at least three seconds with the Auto/Manual Switch parameter displayed.

To move from any of the levels within the dotted line, press the Key for at least one seconds. (However, the PF Setting parameter must be set to A-M.)

For details on the setting method, refer to *5-11 Performing Manual Control*.

- The MANU indicator will light during manual control.
- During manual operation, it is not possible to move to any displays other than the PV/MV (Manual MV).

---

**PV/MV (Manual MV)**

---



- The manual control level display appears as shown below.

PV/Manual MV

	Monitor range	Unit
Process value	Temperature: According to indication range for each sensor. Analog: Scaling lower limit -5% FS to Scaling upper limit +5% FS (Refer to A-7 Sensor Input Setting Range, Indication Range, Control Range.)	EU
Set point	SP lower limit to SP upper limit	EU

	Setting range		Unit
MV (Manual MV)	Standard control	-5.0 to 105.0*	%
	Position-proportional control		
	Heating/cooling control	-105.0 to 105.0*	

- \* When the Manual MV Limit Enable parameter is set to ON, the setting range will be the MV lower limit to the MV upper limit.



- Related Parameters**

Standard or Heating/Cooling (Initial Setting Level): Page 6-64

## 6-9 Initial Setting Level

This level is used to set up the basic Digital Controller specifications. In this level, you can set the Input Type parameter to set the sensor input to be connected, limit the setting range of set points, set the alarm modes, and perform other operations.

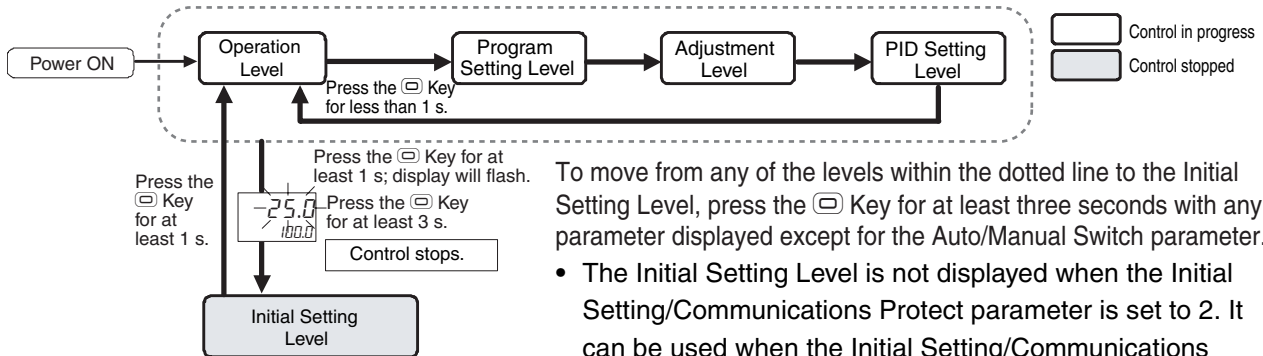

To move from any of the levels within the dotted line to the Initial Setting Level, press the Key for at least three seconds with any parameter displayed except for the Auto/Manual Switch parameter.

- The Initial Setting Level is not displayed when the Initial Setting/Communications Protect parameter is set to 2. It can be used when the Initial Setting/Communications Protect parameter is set to 0 or 1.
- If the Input Type parameter is set for an analog input, the following parameters will be set: Scaling upper limit, Scaling lower limit, and Decimal point.

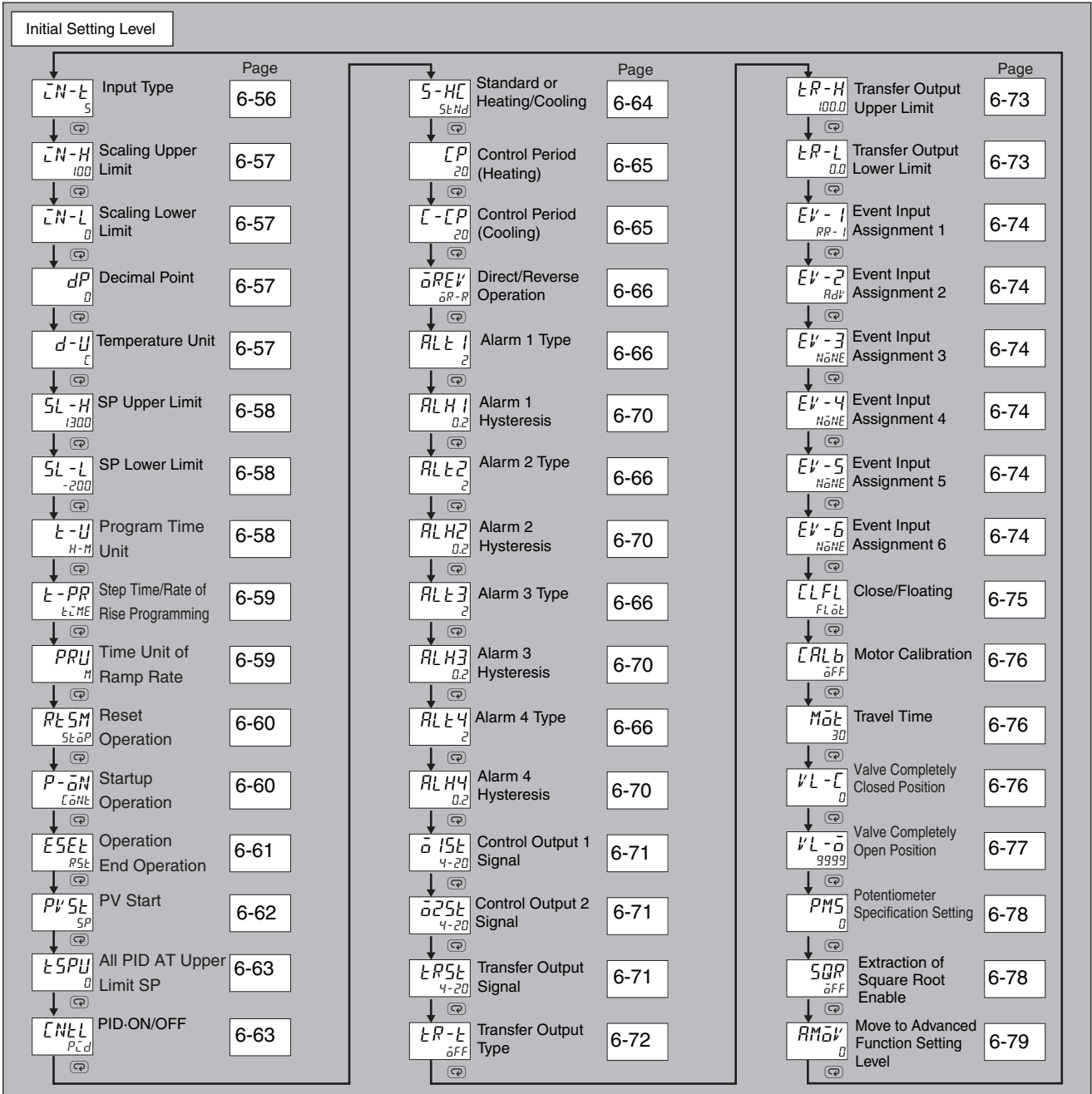

## LN-t Input Type



Function

- The Input Type parameter is used to set the input type.
- When this parameter is changed, the set point limiter is changed to the defaults. If the limiter must be specified, set the SP Upper Limit and SP Lower Limit parameters (Initial Setting Level) again.
- If a resistance thermometer is mistakenly connected while a setting for other than a resistance thermometer is in effect, *S.ERR* will be displayed. To clear the *S.ERR* display, check the wiring and then cycle the power.



Setting

Input type	Sensor specification	Set value	Temperature range in °C	Temperature range in °F
Resistance thermometer	Pt100	0	-200 to 850	-300 to 1500
		1	-199.9 to 500.0	-199.9 to 900.0
		2	0.0 to 100.0	0.0 to 210.0
	JPt100	3	-199.9 to 500.0	-199.9 to 900.0
		4	0.0 to 100.0	0.0 to 210.0
Thermocouple	K	5 (default)	-200 to 1300	-300 to 2300
		6	-20.0 to 500.0	0.0 to 900.0
	J	7	-100 to 850	-100 to 1500
		8	-20.0 to 400.0	0.0 to 750.0
	T	9	-200 to 400	-300 to 700
		10	-199.9 to 400.0	-199.9 to 700.0
	E	11	-200 to 600	-300 to 1100
	L	12	-100 to 850	-100 to 1500
	U	13	-200 to 400	-300 to 700
		14	-199.9 to 400.0	-199.9 to 700.0
	N	15	-200 to 1300	-300 to 2300
	R	16	0 to 1700	0 to 3000
	S	17	0 to 1700	0 to 3000
B	18	100 to 1800	300 to 3200	
W	19	0 to 2300	0 to 3200	
PLII	20	0 to 1300	0 to 2300	
Infrared Temperature Sensor ES1B	10 to 70°C	21	0 to 90	0 to 190
	60 to 120°C	22	0 to 120	0 to 240
	115 to 165°C	23	0 to 165	0 to 320
	140 to 260°C	24	0 to 260	0 to 500
Current input	4 to 20 mA	25	One of the following ranges according to the scaling: -1999 to 9999 -199.9 to 999.9 -19.99 to 99.99 -1.999 to 9.999	
	0 to 20 mA	26		
Voltage input	1 to 5 V	27		
	0 to 5 V	28		
	0 to 10V	29		

### ● Related Parameters



See

Temperature Unit (Initial Setting Level): Page 6-57

Set Point Upper Limit and Set Point Lower Limit (initial Setting Level): Page 6-58



**$\bar{N}-H$**       **Scaling Upper Limit**

**$\bar{N}-L$**       **Scaling Lower limit**

The input type must be set for an analog input.

**$dP$**       **Decimal Point**



Function

- The Decimal Point parameter specifies the decimal point position of parameters (set point, etc.) whose unit is EU.



Setting

- Scaling Upper Limit, Scaling Lower Limit

Parameter name	Setting range	Default
Scaling Upper Limit	Scaling lower limit + 1 to 9999	100
Scaling Lower Limit	-1999 to scaling upper limit - 1	0

- Decimal Point

Parameter name	Setting range	Default
Decimal Point	0 to 3	0

Set value	Settings	Example
0	0 digits past decimal point	1234
1	1 digits past decimal point	123.4
2	2 digits past decimal point	12.34
3	3 digits past decimal point	1.234



### ● Related Parameters

Input Type (Initial Setting Level): Page 6-56

**$d-U$**       **Temperature Unit**

The input type must be set for a temperature input.



Function

- Set the temperature input unit to either °C or °F.



Setting

Setting range	Default
$\bar{L}$ : °C, $F$ : °F	$\bar{L}$



### ● Related Parameters

Input Type (Initial Setting Level): Page 6-56

**SL - H** SP Upper Limit**SL - L** SP Lower Limit

- These parameters set the upper and lower limits of the set points. A set point can be set within the range defined by the upper and lower limit set values in the SP Upper Limit and SP Lower Limit parameters. If these parameters are reset, any set point that is outside of the new range will be forcibly changed to either the upper limit or the lower limit.
- When the temperature input type and temperature unit have been changed, the set point upper limit and set point lower limit are forcibly changed to the upper and lower limits of the sensor.
- For a temperature input, the decimal point position depends on the currently selected sensor, and for an analog input it depends on the Decimal Point parameter setting.



Parameter name		Setting range	Unit	Default
Set Point Upper Limit	Temperature input	SP lower limit + 1 to Input setting range upper limit	EU	1300
	Analog input	SP lower limit + 1 to scaling upper limit	EU	100
Set Point Lower Limit	Temperature input	Input setting range lower limit to SP upper limit - 1	EU	-200
	Analog input	Scaling lower limit to SP upper limit - 1	EU	0



- **Related Parameters**

Input Type (Initial Setting Level): Page 6-56

Temperature Unit (Initial Setting Level): Page 6-57

**t - U** Program Time Unit

- This parameter sets the time unit for the program.
- This parameter sets the time unit for the following parameters. Always set this time unit before setting the following parameters.
  - Segment Times
  - Time Signal ON Times and Time Signal OFF Times



Setting range	Unit	Default
<i>H - M</i> : hours and minutes	---	<i>H - M</i> : hours and minutes
<i>M - S</i> : minutes and seconds		minutes

## $t$ -PR Step Time/Rate of Rise Programming



Function

This parameter specifies the segment setting method when a program is set. There are two methods: Step Time, in which the arrival time and arrival SP are set, and Rate of Rise Programming, in which the segment type is set (to ramp, soak, or step) and the values are set.

The setting method that you select does not affect the program patterns that you can create.



Setting

Setting range	Unit	Default
$t$ : Step time	---	$t$ : Step time
$PR$ : Rate of rise programming		



See

### ● Related Sections

5-15 Program-related Functions (page 5-53)

## PRU Time Unit of Ramp Rate

The Step Time/Rate of Rise Programming parameter must be set to Rate of Rise Programming.



Function

This parameter sets the time unit for the denominator of the Segment Slope parameter. Example: If the Segment Ramp Rate parameter is set to 100 and the Time Unit of Ramp Rate parameter is set to M (minutes), the program SP will change at a rate of 100 per minute toward the segment SP.



Setting

Setting range	Unit	Default
H: Hours	---	M: Minutes
M: Minutes		



See

### ● Related Sections

5-15 Program-related Functions (page 5-53)

### ● Related Parameters

Step Time/Rate of Rise Programming (Initial Setting Level): Page 6-59

## RESET Reset Operation



Function

This parameter sets the control operation to perform when a reset has been performed.

- Stopping control: Control is stopped. If an MV is set for the MV at reset, it is output.
- Fixed SP operation: Control is executed for a fixed SP (FSP). The mode will always be Fixed SP Mode.



Setting

Setting range	Unit	Default
<i>STOP</i> : Stopping control	---	<i>STOP</i> : Stopping control
<i>FSP</i> : Fixed SP operation		

- \* If fixed SP operation is set, control while resetting will be performed with the set value of the Fixed SP parameter. Control will not stop.



### ● Related Sections

5-15 Program-related Functions (page 5-53)

## P-ON Startup Operation



Function

- This parameter sets the operating status when the power is turned ON.
- The specified operation is also used for software resets and when moving from Initial Setting Level to Operation Level.



Setting

Setting range	Unit	Default
<i>CONT</i> : Continue	---	<i>CONT</i> : Continue
<i>RST</i> : Reset		
<i>RUN</i> : Run		
<i>MANU</i> : Manual Mode*		

- \* If the PID ON/OFF parameter is set to ON/OFF, Manual Mode cannot be selected.



### ● Rated Sections

4-7 Setting Programs (page 4-27)

## ESEt Operation End Operation



This parameter sets the operation to perform when the program has been completed.

- **Reset:** Operation ends
- **Continue:** Operation is continued using the SP of the last segment. The final segment number is held and the elapsed program time is held. The Hold and Advance parameters cannot be used. The time signals hold the status at the end of operation.
- **Fixed SP Mode:** Operation continues in Fixed SP Mode when the program has been completed. The segment number and elapsed program time return to the start and are held. Time signals are turned OFF before the end of program operation. The program is restarted when the SP Mode parameter is changed to Program SP (PSP).



Setting range	Unit	Default
RSEt: Reset	---	RSEt: Reset
CONT: Continue		
FSP: Fixed SP Mode*		

\* The Fixed SP Mode cannot be selected if the reset operation is set to fixed SP operation.



### ● Rated Sections

5-15 Program-related Functions (page 5-53)

*PV St* PV Start

The Step Time/Rate of Rise Programming parameter must be set to Step Time, or the Step Time/Rate of Rise Programming parameter must be set to Rate of Rise and the Reset Operation parameter must be set to Fixed SP Operation.



Function

- This parameter sets the starting method for program operation.
- If program repetitions or program links are set, the PV Start operates only for the first program execution.
- The following table outlines the starting SP and the starting point for each method.

Starting method	SP at start of operation	Operation starting point
SP Start	Segment 0 SP	Program operates in order from SP of segment 0.
Slope-priority PV Start	Present value at start of operation	Operation starts at the first SP in the program pattern that matches the PV at the start of operation. If the PV does not match any SP in the program pattern, operation starts at the beginning of the program.



Setting

Setting range	Unit	Default
<i>SP</i> : SP-priority SP start	---	<i>SP</i> : SP start
<i>PV</i> : Slope-priority PV start		



See

- **Rated Sections**  
5-15 Program-related Functions (page 5-53)

- **Related Parameters**  
Step Time/Rate of Rise Programming (Initial Setting Level): Page 6-59  
Reset Operation (Initial Setting Level): Page 6-60

**ESPU****All PID AT Upper Limit SP**

**Control must be set to 2-PID control and the PID Set Automatic Selection Data parameter must not be set to DV (deviation).**

This parameter sets the last SP for auto-tuning when auto-tuning all PID sets.



- You can set the last SP for auto-tuning when auto-tuning all PID sets.
- When you auto-tune all PID sets, auto-tuning is performed from the Fixed SP value to the All PID AT Upper Limit SP value.
- If the Fixed SP value is greater than or equal to the All PID Upper Limit SP value (for normal operation, it must be less than or equal), auto-tuning is performed only for the Fixed SP value.



Setting range	Unit	Default
SP Lower Limit to SP Upper Limit	EU	0



### ● Related Parameters

- PID ON/OFF (Initial Setting Level): Page 6-63
- AT Execute/Cancel (Adjustment Level): Page 6-27
- Fixed SP (Adjustment Level): Page 6-28
- PID \* Automatic Selection Range Upper Limit (PID Setting Level): Page 6-49
- Set Point Upper Limit (Initial Setting Level): Page 6-58
- Set Point Lower Limit (Initial Setting Level): Page 6-58

**ENEL****PID-ON/OFF**

**A Standard Model must be used.**



- This parameter selects 2-PID control or ON/OFF control.
- The auto-tuning function can be used in 2-PID control.



Setting range	Default
$PID$ : 2-PID, $ON/OFF$ : ON/OFF	$ON/OFF$



### ● Related Parameters

- AT Execute/Cancel (Adjustment Level): Page 6-27
- Manual Reset Value (Adjustment Level): Page 6-38
- Hysteresis (Heating) and Hysteresis (Cooling) (Adjustment Level): Page 6-38

**S-HC****Standard or Heating/Cooling****A Standard Model must be used.**

- This parameter selects standard control or heating/cooling control.
- If heating/cooling control is selected for the E5CC-T when there is only one control output, the auxiliary output 2 terminal (SUB2) is assigned as the control output for cooling.
- If heating/cooling control is selected for the E5EC-T/E5AC-T when there is only one control output, the auxiliary output 4 terminal (SUB4) is assigned as the control output for cooling.

Note: If standard control is selected, set the Control Output 1 Assignment to  $\bar{a}$  (control output (heating)) for either direct (cooling) or reverse (heating) operation.



Setting range	Default
<i>S</i> $\bar{E}N$ <i>d</i> : Standard, <i>H-C</i> : Heating/cooling	<i>S</i> $\bar{E}N$ <i>d</i>



- **Related Parameters**

MV Monitor (Heating) (Operation Level): Page 6-14

MV Monitor (Cooling) (Operation Level): Page 6-15

Dead Band (Adjustment Level): Page 6-37

Hysteresis (Heating) and Hysteresis (Cooling) (Adjustment Level): Page 6-38

Control Period (Heating) and Control Period (Cooling) (Initial Setting Level): Page 6-65

Control Output 1 and 2 Assignment (Advanced Function Setting Level): Page 6-97

Auxiliary Output 1 to 4 Assignment (Advanced Function Setting Level): Page 6-98



[P  
[-[P

Control Period (Heating)

Control Period (Cooling)

The cooling control output and heating control output must be assigned to relay or voltage outputs (for driving SSR).

The control must be set to 2-PID control.

For the Control Period (Cooling) parameter, the control must be set to heating/cooling control.



Function

- These parameters set the output periods. Set the control periods taking the control characteristics and the electrical life of the relay into consideration.
- For standard control, use the Control Period (Heating) parameter. The Control Period (Cooling) parameter cannot be used.
- When the heating or cooling control output is a linear current output, the Control Period (Heating or Cooling) parameter cannot be used.
- For heating/cooling control, the control period can be set independently for heating and cooling. The Control Period (Heating) parameter is used for the heating control output, and the Control Period (Cooling) parameter is used for the cooling control output.



Setting

Parameter name	Setting range	Unit	Default
Control Period (Heating)	0.1, 0.2, 0.5, 1 to 99	Seconds	20 for relay output
			2 for voltage output (for driving SSR)
Control Period (Cooling)	0.1, 0.2, 0.5, 1 to 99	Seconds	20 for relay output
			2 for voltage output (for driving SSR)



See

#### ● Related Parameters

PID ON/OFF (Initial Setting Level): Page 6-63

**REV** Direct/Reverse Operation



- "Direct operation" refers to control where the manipulated variable is increased when the process value increases. Alternatively, "reverse operation" refers to control where the manipulated variable is increased when the process value decreases.

Setting range	Default
$\bar{a}R-R$ : Reverse operation, $\bar{a}R-d$ : Direct operation	$\bar{a}R-R$

- AL1** Alarm 1 Type Alarm 1 must be assigned.
- AL2** Alarm 2 Type Alarm 2 must be assigned.
- AL3** Alarm 3 Type Alarm 3 must be assigned.
- AL4** Alarm 4 Type Alarm 4 must be assigned.



- Set the alarm type independently for each alarm in the Alarm 1 to 4 Type parameters in the Initial Setting Level.
- The alarms that can be set are listed in the following table.
- You can use an LBA (12) only for alarm 1. You cannot use an LBA on a Position-proportional Model.

Set value	Alarm type	Alarm output operation		Description of function
		When alarm value X is positive	When alarm value X is negative	
0	Alarm function OFF	Output OFF		No alarm
1	Upper- and lower-limit <sup>*1</sup>		<sup>*2</sup>	Set the upward deviation in the set point for the alarm upper limit (H) and the lower deviation in the set point for the alarm lower limit (L). The alarm is ON when the PV is outside this deviation range.
2 (default)	Upper-limit			Set the upward deviation in the set point by setting the alarm value (X). The alarm is ON when the PV is higher than the SP by the deviation or more.
3	Lower-limit			Set the downward deviation in the set point by setting the alarm value (X). The alarm is ON when the PV is lower than the SP by the deviation or more.

Set value	Alarm type	Alarm output operation		Description of function
		When alarm value X is positive	When alarm value X is negative	
4	Upper- and lower-limit range <sup>*1</sup>		*3	Set the upward deviation in the set point for the alarm upper limit (H) and the lower deviation in the set point for the alarm lower limit (L). The alarm is ON when the PV is inside this deviation range.
5	Upper- and lower-limit with standby sequence <sup>*1</sup>		*4	A standby sequence is added to the upper- and lower-limit alarm (1). <sup>*6</sup>
6	Upper-limit with standby sequence			A standby sequence is added to the upper-limit alarm (2). <sup>*6</sup>
7	Lower-limit with standby sequence			A standby sequence is added to the lower-limit alarm (3). <sup>*6</sup>
8	Absolute-value upper-limit			The alarm will turn ON if the process value is larger than the alarm value (X) regardless of the set point.
9	Absolute-value lower-limit			The alarm will turn ON if the process value is smaller than the alarm value (X) regardless of the set point.
10	Absolute-value upper-limit with standby sequence			A standby sequence is added to the absolute-value upper-limit alarm (8). <sup>*6</sup>
11	Absolute-value lower-limit with standby sequence			A standby sequence is added to the absolute-value lower-limit alarm (9). <sup>*6</sup>
12	LBA (alarm 1 type only)			*7
13	PV change rate alarm			*8
14	SP absolute-value upper-limit alarm			This alarm type turns ON the alarm when the set point (SP) is higher than the alarm value (X).
15	SP absolute-value lower-limit alarm			This alarm type turns ON the alarm when the set point (SP) is smaller than the alarm value (X).
16	MV absolute-value upper-limit alarm <sup>*9</sup>	Standard Control	Standard Control	This alarm type turns ON the alarm when the manipulated variable (MV) is higher than the alarm value (X).
		Heating/Cooling Control (Heating MV)	Heating/Cooling Control (Heating MV)	
			Always ON	

Set value	Alarm type	Alarm output operation		Description of function
		When alarm value X is positive	When alarm value X is negative	
17	MV absolute-value lower-limit alarm*9	Standard Control 	Standard Control 	This alarm type turns ON the alarm when the manipulated variable (MV) is lower than the alarm value (X).
		Heating/Cooling Control (Cooling MV) 	Heating/Cooling Control (Cooling MV) Always ON	

\*1 With set values 1, 4 and 5, the upper- and lower- limit values can be set independently for each alarm type, and are expressed as "L" and "H."

\*2 Set value: 1 (Upper- and lower-limit alarm)

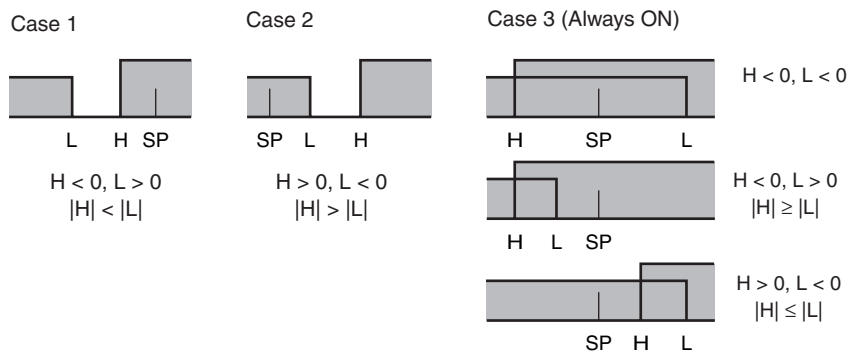

\*3 Set value: 4 (Upper- and lower-limit range)

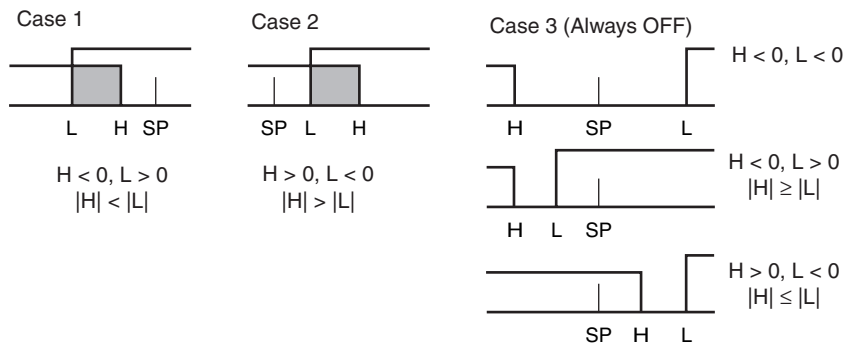

\*4 Set value: 5 (Upper- and lower-limit alarm with standby sequence)

- For the upper- and lower-limit alarms in cases 1 and 2 above, the alarm is always OFF if upper- and lower-limit hysteresis overlaps.
- In case 3, the alarm is always OFF.

\*5 Set value: 5 (Upper- and lower-limit alarm with standby sequence)

- The alarm is always OFF if upper- and lower-limit hysteresis overlaps.

\*6 Refer to *Standby Sequence Reset* on page 6-83 for information on the operation of the standby sequence.

\*7 Refer to *5-10-1 Loop Burnout Alarm (LBA)*.

\*8 Refer to *PV Change Rate Alarm* on page 4-60.

\*9 When heating/cooling control is performed, the MV absolute-value upper-limit alarm functions only for the heating operation and the MV absolute-value lower-limit alarm functions only for the cooling operation.

- If the Controller is equipped with HB/HS alarm detection, the Alarm 1 Type is not displayed for the default settings. To use alarm 1, set an output assignment to alarm 1. (Refer to *4-6-3 Assigned Output Functions (Assigning Control Outputs Is Not Supported for Position-proportional Models.)*.)



### ● Related Parameters

Alarm Value 1 to 4 (Operation Level): Page 6-20

Alarm Value Upper Limit 1 to 4 and Alarm Value Lower Limit 1 to 4 (Operation Level):  
Page 6-21

Alarm 1 to 4 Hysteresis (Initial Setting Level): Page 6-70

Standby Sequence Reset (Advanced Function Setting Level): Page 6-83

Auxiliary Output 1 to 4 Open in Alarm (Advanced Function Setting Level): Page 6-84

Alarm 1 to 4 Latch (Advanced Function Setting Level): Page 6-89

<b>ALH1</b>	<b>Alarm 1 Hysteresis</b>	<b>Alarm 1 must be assigned. The alarm 1 type must not be 0, 12, or 13.</b>
<b>ALH2</b>	<b>Alarm 2 Hysteresis</b>	<b>Alarm 2 must be assigned. The alarm 2 type must not be 0, 12, or 13.</b>
<b>ALH3</b>	<b>Alarm 3 Hysteresis</b>	<b>Alarm 3 must be assigned. The alarm 3 type must not be 0, 12, or 13.</b>
<b>ALH4</b>	<b>Alarm 4 Hysteresis</b>	<b>Alarm 4 must be assigned. The alarm 4 type must not be 0, 12, or 13.</b>



Function

- These parameters set the hysteresis for alarms 1, 2, 3, and 4.



Setting

#### Alarms Other Than an MV Alarm

	Setting range	Unit	Default
Temperature input	0.1 to 999.9	°C or °F	0.2
Analog input	0.01 to 99.99	%FS	0.02

#### MV Alarms

Setting range	Unit	Unit
0.01 to 99.99	%	0.50



See

#### ● Related Parameters

Alarm Value 1 to 4 (Operation Level): Page 6-20

Alarm Value Upper Limit 1 to 4 and Alarm Value Lower Limit 1 to 4 (Operation Level):  
Page 6-21

Alarm 1 to 4 Type (Initial Setting Level): Page 6-66

Standby Sequence Reset (Advanced Function Setting Level): Page 6-83

Auxiliary Output 1 to 4 Open in Alarm (Advanced Function Setting Level): Page 6-84

Alarm 1 to 4 Latch (Advanced Function Setting Level): Page 6-89

***015t*****Control Output 1 Signal****Control output 1 must be a linear current output.*****025t*****Control Output 2 Signal****Control output 2 must be a linear current output.**

Function

These parameters set the output signal for linear current outputs.

- Select 4 to 20 mA or 0 to 20 mA for the signal.



Setting

Setting range	Default
<i>4-20</i> : 4 to 20mA	<i>4-20</i>
<i>0-20</i> : 0 to 20mA	

***1R5t*****Transfer Output Signal****There must be a transfer output.**

Function

This parameter sets the output signal for the transfer output.

- Select 4 to 20 mA or 1 to 5 V.



Setting

Setting range	Default
<i>4-20</i> : 4 to 20mA	<i>4-20</i>
<i>1-5V</i> : 1 to 5 V	

**LR-L****Transfer Output Type****There must be a transfer output.**

Function

- This parameter sets the transfer output type.



Setting

Transfer output type		Default
OFF	$\bar{OFF}$	$\bar{OFF}$
Present SP	$SP-M$	
PV	$PV$	
MV (heating) <sup>*1</sup>	$MV$	
MV (cooling) <sup>*2</sup>	$\bar{C}-MV$	
Valve opening <sup>*3</sup>	$V-M$	

\*1 This function can be set for a Position-proportional Model, but the setting will be disabled.

\*2 This function can be set for standard control or for a Position-proportional Model, but the setting will be disabled.

\*3 This setting is displayed only for a Position-proportional Model.



### ● Related Parameter

Transfer Output Upper Limit and Transfer Output Lower Limit (Initial Setting Level): Page 6-73



**ER-H**      Transfer Output Upper Limit

There must be a transfer output.

**ER-L**      Transfer Output Lower Limit

The transfer output type must not be set to OFF.



Function

- This parameter sets the upper and lower limit values of transfer outputs.



Setting

Transfer output type	Setting range		Default		Unit
			Transfer output lower limit	Transfer output upper limit	
Present SP	SP lower limit to SP upper limit		SP lower limit	SP upper limit	EU
PV	Temperature input	Input setting range lower limit to input setting range upper limit	Input setting range lower limit	Input setting range upper limit	
	Analog input	Analog scaling lower limit to analog scaling upper limit	Scaling lower limit	Scaling upper limit	
MV (heating) <sup>*1</sup>	Standard	-5.0 to 105.0	0.0	100.0	%
MV (cooling) <sup>*2</sup>	Heating/cooling	0.0 to 105.0			
Valve opening <sup>*3</sup>	Position-proportional control	-10.0 to 110.0			

\*1 This function can be set for a Position-proportional Model, but the setting will be disabled.

\*2 This function can be set for standard control or for a Position-proportional Model, but the setting will be disabled.

\*3 This setting is displayed only for a Position-proportional Model.



See

● **Related Parameter**

Transfer Output Type (Initial Setting Level): Page 6-72

---

<b><i>EV-1</i></b>	<b>Event Input Assignment 1</b>	<b>There must be event inputs.</b>
<b><i>EV-2</i></b>	<b>Event Input Assignment 2</b>	
<b><i>EV-3</i></b>	<b>Event Input Assignment 3</b>	
<b><i>EV-4</i></b>	<b>Event Input Assignment 4</b>	
<b><i>EV-5</i></b>	<b>Event Input Assignment 5</b>	
<b><i>EV-6</i></b>	<b>Event Input Assignment 6</b>	

---



- The following functions can be assigned to event inputs 1 to 6.
  - Run (OFF)/Reset (ON)
  - Run (ON)/Reset (OFF)
  - Auto/Manual
  - Reset
  - Run
  - Hold/Clear Hold
  - Hold
  - Advance
  - Program Number Switch 0 to 2
  - Direct/Reverse Operation
  - Program SP Mode/Fixed SP Mode
  - 100% AT Execute/Cancel
  - 40% AT Execute/Cancel
  - All PID 100% AT Execute/Cancel
  - All PID 40% AT Execute/Cancel
  - Setting Change Enable/Disable
  - Communications Writing Enable/Disable
  - Alarm Latch Cancel
  - Wait Enable (ON)/Disable (OFF)
- Default:
 

Event Input Assignment 1:	<i>RR-1</i>
Event Input Assignment 2:	<i>RdV</i>
Event Input Assignment 3:	<i>NONE</i>
Event Input Assignment 4:	<i>NONE</i>
Event Input Assignment 5:	<i>NONE</i>
Event Input Assignment 6:	<i>NONE</i>



Setting	Function
<i>NONE</i>	None
<i>RR-1</i>	Run (OFF)/Reset (ON)
<i>RR-2</i>	Run (ON)/ Reset (OFF)
<i>MANU</i>	Auto/Manual
<i>RSE</i>	Reset
<i>RUN</i>	Run
<i>HLd1</i>	Hold/Clear Hold
<i>HLd2</i>	Hold
<i>Adv</i>	Advance
<i>PRG0</i>	Program Number Switch 0
<i>PRG1</i>	Program Number Switch 1
<i>PRG2</i>	Program Number Switch 2
<i>dRS</i>	Direct/Reverse Operation
<i>SPM</i>	Program SP Mode/Fixed SP Mode
<i>RE-2</i>	100% AT Execute/Cancel
<i>RE-1</i>	40% AT Execute/Cancel* <sup>1</sup>
<i>REAR2</i>	All PID 100% AT Execute/Cancel
<i>REAR1</i>	All PID 40% AT Execute/Cancel* <sup>1</sup>
<i>WEPE</i>	Setting Change Enable/Disable
<i>EMWE</i>	Communications Writing Enable/Disable* <sup>2</sup>
<i>LAL</i>	Alarm Latch Cancel
<i>WAL</i>	Wait Enable (ON)/Disable (OFF)

- \*1 This function can be set for heating/cooling control or for floating control for Position-proportional Models, but the setting will be disabled.
- \*2 This function can be set only for a Controller that supports communications. Also, if a work bit is selected as the event input data, you cannot select communications writing enable/disable.

## **CLFL** Close/Floating

**A Position-proportional Model must be used.**



- The Close/Floating parameter is used to set the control method for a Position-proportional Model.



Setting range	Default
<i>FLot</i> : Floating control	<i>FLot</i>
<i>CLoS</i> : Close control	

**CLb****Motor Calibration****A Position-proportional Model must be used.**

Function

The Motor Calibration parameter is used to calibrate the valve position and automatically set the travel time from completely open to completely closed. You can then check the valve opening with the Valve Opening Monitor parameter.



Operation

If you set the Motor Calibration parameter to ON, the valve will open completely and close completely, and then the setting of the parameter will change to OFF when the measurement has been completed. "ERR" will be displayed if any of the following errors occurs during execution. If an error occurs, check the wiring and other factors and execute motor calibration again.

- The potentiometer input value does not change or changes backward between completely open and completely closed because the wiring is wrong.
- The value of the potentiometer input is incorrect because of a broken wire, noise, or other factor.
  - \* Do not change to any other parameter during calibration.



- **Related Parameters**

Travel Time (Initial Setting Level): Page 6-76

**Mot****Travel Time****A Position-proportional Model must be used.**

Function

- The Travel Time parameter is set to the time from when the valve is completely open until it is completely closed.
- This parameter is set automatically when motor calibration is executed. There is normally no need to change it manually.
- To use the results of automatic motor calibration calculations with another Digital Controller, set the following parameters as a set: Travel Time, Valve Completely Closed Position, Valve Completely Open Position, and Potentiometer Specification Setting. However, these settings will depend on the equipment. When precise operation is required, execute motor calibration separately for each piece of equipment.



Operation

Setting range	Unit	Default
1 to 999	Seconds	30



- **Related Sections**

5-21 Controlling Valves (Can Be Used with a Position-proportional Model) (page 5-79)

- **Related Parameters**

Motor Calibration (Initial Setting Level): Page 6-76

**VL-C****Valve Completely Closed Position****A Position-proportional Model must be used.**



Function

- This parameter sets the count that indicates the position where the valve is completely closed.
- This parameter is set automatically when motor calibration is executed. There is normally no need to change it manually.
- To use the results of automatic motor calibration calculations with another Digital Controller, set the following parameters as a set: Travel Time, Valve Completely Closed Position, Valve Completely Open Position, and Potentiometer Specification Setting. However, these settings will depend on the equipment. When precise operation is required, execute motor calibration separately for each piece of equipment.



Operation

Setting range	Unit	Default
0 to 9,999	---	0



See

### ● Related Sections

5-21 Controlling Valves (Can Be Used with a Position-proportional Model) (page 5-79)

### ● Related Parameters

Motor Calibration (Initial Setting Level): Page 6-76

---

**V<sub>L</sub>- $\bar{0}$** 
**Valve Completely Open Position**
**A Position-proportional Model must be used.**

Function

- This parameter sets the count that indicates the position where the valve is completely open.
- This parameter is set automatically when motor calibration is executed. There is normally no need to change it manually.
- To use the results of automatic motor calibration calculations with another Digital Controller, set the following parameters as a set: Travel Time, Valve Completely Closed Position, Valve Completely Open Position, and Potentiometer Specification Setting. However, these settings will depend on the equipment. When precise operation is required, execute motor calibration separately for each piece of equipment.



Operation

Setting range	Unit	Default
0 to 9,999	---	9999



See

### ● Related Sections

5-21 Controlling Valves (Can Be Used with a Position-proportional Model) (page 5-79)

### ● Related Parameters

Motor Calibration (Initial Setting Level): Page 6-76

**PMS****Potentiometer Specification Setting****A Position-proportional Model must be used.**

- This parameter is used to set a number that indicates a potentiometer specification, the resistance range.
- This parameter is set automatically according to the potentiometer specification when motor calibration is executed. There is normally no need to change it manually.
- To use the results of automatic motor calibration calculations with another Digital Controller, set the following parameters as a set: Travel Time, Valve Completely Closed Position, Valve Completely Open Position, and Potentiometer Specification Setting. However, these settings will depend on the equipment. When precise operation is required, execute motor calibration separately for each piece of equipment.



Setting range	Unit	Default
0 to 5	---	0



- **Related Sections**

*5-21 Controlling Valves (Can Be Used with a Position-proportional Model)* (page 5-79)

- **Related Parameters**

Motor Calibration (Initial Setting Level): Page 6-76

**SQR****Extraction of Square Root Enable An analog input must be supported.**

This parameter enables and disables square root extraction.



Setting range	Default
<i>ON</i> : Enabled, <i>OFF</i> : Disabled	OFF



- **Related Parameter**

Extraction of Square Root Low-cut Point (Adjustment Level): Page 6-42

**Move to Advanced Function  
Setting Level****The Initial Setting/Communications Protect  
parameter must be set to 0.**

Function

- Set the Move to Advanced Function Setting Level parameter set value to "-169."
- Move to the advanced function setting level either by pressing Key or Key or by waiting or two seconds to elapse.



See

**● Related Parameter**

Initial Setting/Communication Protect (Protect Level): Page 6-4

## 6-10 Advanced Function Setting Level

The Advanced Function Setting Level is used for optimizing Controller performance. To move to this level, input the password ("–169") from the Initial Setting Level.

To be able to enter the password, the Initial Setting/Communications Protect parameter in the Protect Level must be set to 0.

### Moving to Advanced Function Setting Level

- 1** Move from the Operation Level to the Protect Level.
- 2** Display the Initial Setting/Communications Protect parameter.

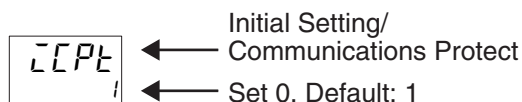

- 3** Change the set value to 0.
- 4** Move from the Protect Level to the Operation Level to the Initial Setting Level.
- 5** Display the Move to Advanced Function Setting Level parameter.

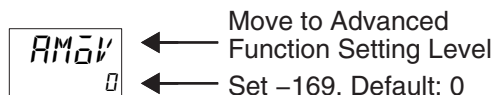

- 6** Change the set value to –169.
- 7** The Advanced Function Setting Level is displayed.  
INIT (INIT) will be displayed.

- The parameters in this level can be used when the Initial Setting/Communications Protect parameter is set to 0.
- To switch between setting levels, press the Key.
- To change set values, press the and Keys.

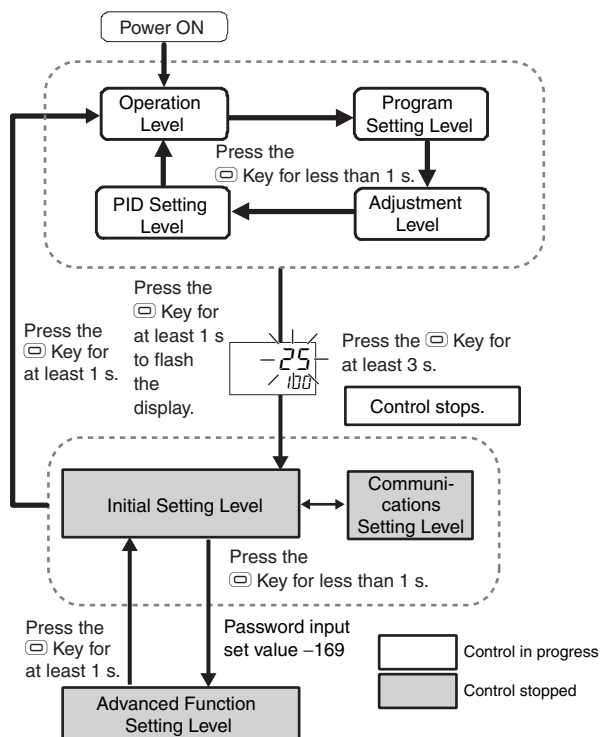



**Advanced Function Setting Level**

Parameter	Description	Page	Parameter	Description	Page	Parameter	Description	Page	Parameter	Description	Page
CNLT	Parameter Initialization	6-82	RLT	Alarm 1 Latch	6-89	LbA	LBA Detection Time	6-95	LCML	LCT Cooling Output Min. ON Time	6-104
PEND	Program End ON Time	6-82	R2LT	Alarm 2 Latch	6-89	LbAL	LBA Level	6-96	PF	PF Setting	6-105
S-U	Standby Time Unit	6-82	R3LT	Alarm 3 Latch	6-89	LbAb	LBA Band	6-96	PFd1	PF Monitor/Setting Item 1	6-106
RESL	Standby Sequence Reset	6-83	R4LT	Alarm 4 Latch	6-89	oUt1	Control Output 1 Assignment	6-97	PFd2	PF Monitor/Setting Item 2	6-106
SbIN	Auxiliary Output 1 Open in Alarm	6-84	PRLT	Move to Protect Level Time	6-90	oUt2	Control Output 2 Assignment	6-97	PFd3	PF Monitor/Setting Item 3	6-106
Sb2N	Auxiliary Output 2 Open in Alarm	6-84	CJc	Cold Junction Compensation Method	6-90	SUb1	Auxiliary Output 1 Assignment	6-98	PFd4	PF Monitor/Setting Item 4	6-106
Sb3N	Auxiliary Output 3 Open in Alarm	6-84	RIoN	Alarm 1 ON Delay	6-91	SUb2	Auxiliary Output 2 Assignment	6-98	PFd5	PF Monitor/Setting Item 5	6-106
Sb4N	Auxiliary Output 4 Open in Alarm	6-84	R2oN	Alarm 2 ON Delay	6-91	SUb3	Auxiliary Output 3 Assignment	6-98	SPd1	PV/SP No. 1 Display Selection	6-107
HbU	HB ON/OFF	6-84	R3oN	Alarm 3 ON Delay	6-91	SUb4	Auxiliary Output 4 Assignment	6-98	SPd2	PV/SP No. 2 Display Selection	6-107
HbL	Heater Burnout Latch	6-85	R4oN	Alarm 4 ON Delay	6-91	ALMA	Integrated Alarm Assignment	6-99	PVSL	PV Status Display Function	6-108
HbH	Heater Burnout Hysteresis	6-85	RIoF	Alarm 1 OFF Delay	6-92	ALSP	Alarm SP Selection	6-99	SVSL	SV Status Display Function	6-109
ALFA	$\alpha$	6-86	R2oF	Alarm 2 OFF Delay	6-92	SPTR	SP Tracking	6-100	dREF	Display Refresh Period	6-109
EDU	Integral/Derivative Time Unit	6-86	R3oF	Alarm 3 OFF Delay	6-92	PcLd	PID Set Automatic Selection Data	6-100	bURN	Burnout Method	6-110
RE-G	AT Calculated Gain	6-87	R4oF	Alarm 4 OFF Delay	6-92	PcLH	PID Set Automatic Selection Hysteresis	6-100	PMSL	Parameter Mask Setting	6-110
RE-H	AT Hysteresis	6-87	MANL	Manual Output Method	6-92	P-db	PV Dead Band	6-101	LMoV	Move to Calibration Level	6-110
LCMA	Limit Cycle MV Amplitude	6-87	MANL	Manual MV Initial Value	6-93	MANL	Manual MV Limit Enable	6-101			
CNF	Input Digital Filter	6-87	RT	RT	6-93	PMVd	Direct Setting of Position Proportional MV	6-102			
MAY	Moving Average Count	6-88	HSU	HS Alarm Use	6-94	PVrP	PV Rate of Change Calculation Period	6-102			
RET	Automatic Display Return Time	6-88	HSL	HS Alarm Latch	6-94	HCLM	Heating/Cooling Tuning Method	6-103			
BRCL	Display Brightness	6-88	HSH	HS Alarm Hysteresis	6-95	oMPPW	Minimum Output ON/OFF Band	6-104			

## INLT Parameter Initialization



- This parameter returns all parameter settings to their defaults.
- After the initialization, the set value automatically turns OFF.



Setting range	Default
$\bar{OFF}$ : Initialization is not executed.	$\bar{OFF}$
$FRCT$ : Initializes to the factory settings described in the manual.	

## PEND Program End ON Time



- This parameter sets the pulse width of the program end output. The setting range is ON or 0.0 to 10.0 s. The default is 0.0 s.
- If ON is set, the output will remain ON until the Run/Reset parameter is changed to Run during reset status.



Setting range	Unit	Default
$\bar{ON}$ : Output continuously. 0.0: No output. 0.1 to 10.0	Seconds	$0.0$ : No output.



- **Related Sections**  
*5-15 Program-related Functions* (page 5-53)

- **Related Parameters**  
Control Output 1 and 2 Assignment (Initial Setting Level): Page 6-97  
Auxiliary Output 1 to 4 Assignment (Initial Setting Level): Page 6-98

## S-U Standby Time Unit



- This parameter sets the unit for the standby time. Always set this parameter before setting the standby time.



Setting range	Unit	Default
$H-M$ : Hours and minutes $d-H$ : Days and hours	---	$H-M$ : Hours and minutes



- **Related Parameters**  
Standby Time (Adjustment Level): Page 6-34

**RESET****Standby Sequence Reset****Alarm 1 to 4 type must be 5, 6, 7, 10, or 11.**

Function

- This parameter selects the conditions for enabling reset after the standby sequence of the alarm has been canceled.
  - Output is turned OFF when switching to the Initial Setting Level, Communications Setting Level, Advanced Function Setting Level, or Calibration Level.
  - Condition A
    - At the Start of Operation (including Power ON)
    - When the Run/Reset parameter is changed to Run.
    - When program is started (including when the program is started for program repetition or link).
    - When the segment is changed (including when an advance is executed).
    - When the program number is changed.
    - When the SP of the current segment is changed (including changing the fixed SP in Fixed SP Mode).
    - When an alarm value (alarm upper or lower limit) is changed in the current program.
    - When the PV input shift or PV slope coefficient value is changed.
    - When the program SP shift value is changed.
  - Condition B
    - Power ON
- The following example shows the reset operation when the alarm is a lower-limit alarm with a standby sequence.

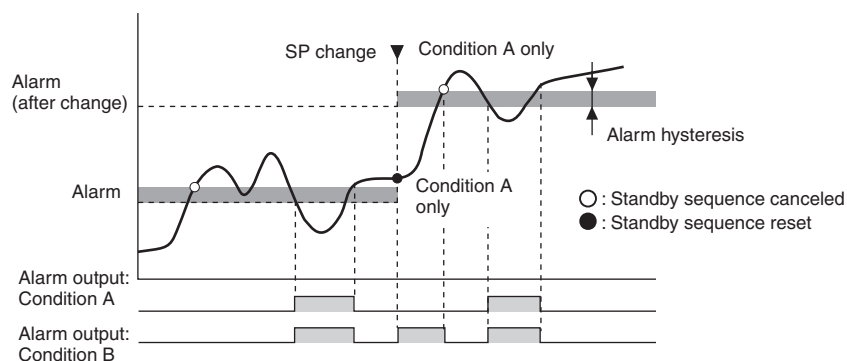

Setting

Setting range	Default
$\bar{A}$ : Condition A, $b$ : Condition B	$\bar{A}$



See

- **Related Parameters**

Alarm 1 to 4 Type (Initial Setting Level): Page 6-66

Alarm 1 to 4 Latch (Advanced Function Setting Level): Page 6-89

---

***Sb IN***      Auxiliary Output 1 Open in Alarm      Auxiliary output 1 must be assigned.

***Sb2N***      Auxiliary Output 2 Open in Alarm      Auxiliary output 2 must be assigned.

***Sb3N***      Auxiliary Output 3 Open in Alarm      Auxiliary output 3 must be assigned.

***Sb4N***      Auxiliary Output 4 Open in Alarm      Auxiliary output 4 must be assigned.

---



- This parameter sets the output status of auxiliary outputs 1 to 4.
- When Close in Alarm is set, the status of the auxiliary output function is output unchanged. When Open in Alarm is set, the status of the auxiliary output function is reversed before being output. The following table shows the relationship between the auxiliary output function, auxiliary output, and operation displays (SUB1 to SUB4).



	Auxiliary output function	Auxiliary output	Operation display (SUB1 to SUB4)
Close in Alarm	ON	ON	Lit
	OFF	OFF	Not lit
Open in Alarm	ON	OFF	Lit
	OFF	ON	Not lit

Setting range	Default
$N-\bar{a}$ : Close in alarm, $N-\bar{L}$ : Open in alarm	$N-\bar{a}$



### ● Related Parameters

Auxiliary Output 1 to 4 Assignment (Advanced Function Setting Level): Page 6-98

---

***HbU***      HB ON/OFF      HB and HS alarms must be supported.

---



- Set to use the heater burnout alarm.



Setting range	Default
$\bar{a}N$ : Enabled, $\bar{a}FF$ : Disabled	$\bar{a}N$

**HbL** Heater Burnout Latch

HB and HS alarms must be supported.  
The HB ON/OFF parameter must be set to ON.



- When this parameter is set to ON, the heater burnout alarm is held until either of the following conditions is satisfied.
  - a Heater burnout detection is set to 0.0 A.
  - b The power is cycled.
  - c The latch is cancelled by the PF Key.  
(PF Setting = LAT: Alarm Latch Cancel)
  - d The latch is cancelled by an event input.  
(Event Input Assignment 1 to Event Input Assignment 6 = LAT: Alarm Latch Cancel)
- The output is turned OFF when switching to the Initial Setting Level, Communications Setting Level, Advanced Function Setting Level, or Calibration Level.



Setting range	Default
$\bar{a}N$ : Enabled, $\bar{a}FF$ : Disabled	$\bar{a}FF$



- **Related Parameters**

- Heater Burnout Detection 1 (Adjustment Level): Page 6-30
- Heater Burnout Detection 2 (Adjustment Level): Page 6-31
- Event Input Assignment 1 to 6 (Initial Setting Level): Page 6-74
- HB ON/OFF (Advanced Function Setting Level): Page 6-84
- PF Setting (Advanced Function Setting Level): Page 6-105

**HbH** Heater Burnout Hysteresis

The HB ON/OFF parameter must be set to ON. The  
Heater Burnout Latch parameter must be set to  
OFF.  
HB and HS alarms must be supported.



- This parameter sets hysteresis for heater burnout detection.



Setting range	Unit	Default
0.1 to 50.0	A	0.1



- **Related Parameters**

- HB ON/OFF (Advanced Function Setting Level): Page 6-84

**ALFA**  $\alpha$ **2-PID control must be set.**

Function

- Normally, use the default for this parameter.
- This parameter sets the 2-PID control a constant.



Setting

Setting range	Default
0.00 to 1.00	0.65



- **Related Parameters**

PID ON/OFF (Initial Setting Level): Page 6-63

**t̄DU****Integral/Derivative Time Unit****Control must be set to 2-PID control.**

Function

This parameter sets the time unit for the Integral Time, Integral Time (Cooling), Derivative Time, and Derivative Time (Cooling) parameters.



Setting

Setting range	Unit	Default
1 to 0.1	Seconds	1

Note: The Integral/Derivative Time Unit parameter changes to 0.1 when the RT (robust tuning) parameter is changed from OFF to ON.



- **Related Parameters**

Integral Time and Derivative Time (Adjustment Level): Page 6-36

Derivative Time (Cooling) and Integral Time (Cooling) (Adjustment Level): Page 6-37

**AE-G** AT Calculated Gain

Control must be set to 2-PID control.

**AE-H** AT Hysteresis

**LCMA** Limit Cycle MV Amplitude

Control must be set to 2-PID control or close position-proportional control.



Function

- Normally use the default values for these parameters.
- The AT Calculated Gain parameter sets the gain for when PID values are calculated using AT. When emphasizing response, decrease the set value. When emphasizing stability, increase the set value.
- The AT Hysteresis parameter sets the hysteresis for limit cycle operation during autotuning when switching ON and OFF.
- The Limit Cycle MV Amplitude parameter sets the MV amplitude for limit cycle operation during autotuning.



Setting

Parameter name	Setting range	Unit	Default
AT Calculated Gain	0.1 to 10.0	---	Standard Model: 0.8 Position-proportional Model: 1.0
AT Hysteresis	Temperature input: 0.1 to 999.9	°C	0.8
		°F	1.4
	Analog input: 0.01 to 9.99	%FS	0.20
Limit Cycle MV Amplitude	5.0 to 50.0	%	20.0



See

● **Related Parameters**

AT Execute/Cancel (Adjustment Level): Page 6-27

**INF** Input Digital Filter



Function

- This parameter sets the time constant for the input digital filter. The following diagram shows the effect on data after passing through the digital filter:

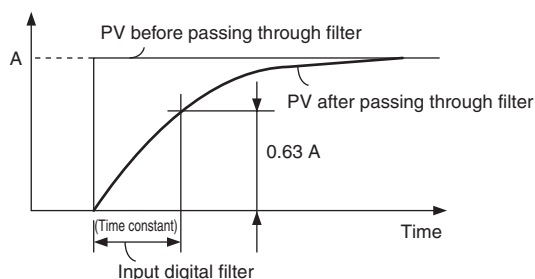

Setting

Setting range	Unit	Default
0.0 to 999.9	Seconds	0.0

**MAV** Moving Average Count

- This parameter sets the number of inputs to include in the moving average. The data after moving average processing is illustrated in the following figure.

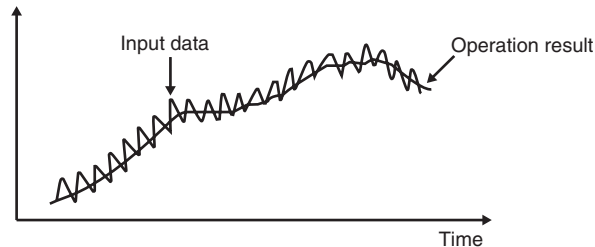

- Use a moving average to suppress rapid changes in the input.



Setting range	Unit	Default
OFF, 2, 4, 8, 16, 32	Times	OFF

**RET** Automatic Display Return Time

- In the Operation Level, Program Setting Level, Adjustment Level, PID Setting Level, or Monitor/Setting Item Level, the display automatically returns to the PV/SP if there are no key operations for the time set for this parameter.
- The automatic display return time is disabled when the parameter is set to OFF. (In that case, the display will not be automatically switched.)



Setting range	Unit	Default
OFF, 1 to 99	Seconds	OFF

**BRGT** Display Brightness

This parameter sets the display brightness to one of three levels. Adjust the level if the display is too bright.



Setting range	Default
1 (dark) to 3 (bright)	3



<b>A1LE</b>	Alarm 1 Latch	Alarm 1 must be assigned, and the alarm 1 type must not be 0.
<b>A2LE</b>	Alarm 2 Latch	Alarm 2 must be assigned, and the alarm 2 type must not be 0 or 12.
<b>A3LE</b>	Alarm 3 Latch	Alarm 3 must be assigned, and the alarm 3 type must not be 0 or 12.
<b>A4LE</b>	Alarm 4 Latch	Alarm 4 must be assigned, and the alarm 4 type must not be 0 or 12.



Function

- When this parameter is set to ON, the alarm function is held until one of the following conditions is satisfied.
  - a The power is cycled.
  - b The latch is cancelled by the PF Key.  
(PF Setting = LAT: Alarm Latch Cancel)
  - c The latch is cancelled by an event input.  
(Event Input Assignment 1 to 6 = LAT: Alarm Latch Cancel)
- The output is turned OFF when switching to the Initial Setting Level, Communications Setting Level, Advanced Function Setting Level, or Calibration Level.
- If an auxiliary output is set to close in alarm, the output is kept closed. If it is set to open in alarm, it is kept open.



Setting

Setting range	Default
$\bar{a}N$ : Enabled, $\bar{a}FF$ : Disabled	$\bar{a}FF$



See

### ● Related Parameters

- Alarm Value 1 to 4 (Operation Level): Page 6-20
- Alarm Value Upper Limit 1 to 4 and Alarm Value Lower Limit 1 to 4 (Operation Level): Page 6-21
- Alarm 1 to 4 Type (Initial Setting Level): Page 6-66
- Standby Sequence Reset (Advanced Function Setting Level): Page 6-83
- Event Input Assignment 1 to 6 (Initial Setting Level): Page 6-74
- Auxiliary Output 1 to 4 Open in Alarm (Initial Setting Level): Page 6-84
- Alarm 1 to 4 Hysteresis (Initial Setting Level): Page 6-70
- HB ON/OFF (Advanced Function Setting Level): Page 6-84
- PF Setting (Advanced Function Setting Level): Page 6-105

---

**PRLt**      Move to Protect Level Time
 

---



- This parameter sets the key pressing time required to move to the Protect Level from the Operation Level, Program Setting Level, Adjustment Level, PID Setting Level, or Monitor/Setting Item Level.



Setting range	Unit	Default
1 to 30	Seconds	3

---

**CJC**
**Cold Junction Compensation Method**
**Input type must be thermocouple or infrared temperature sensor**

---



- This parameter specifies whether cold junction compensation is to be performed internally by the Controller or to be performed externally when the input type setting is 5 to 24.
- The cold junction compensation external setting is enabled when the temperature difference is measured using two thermocouples or two ES1B Sensors.



Setting range	Default
$\bar{0}N$ : Internally, $\bar{0}FF$ : Externally	$\bar{0}N$



- **Related Parameters**

Input Type (Initial Setting Level): Page 6-56

<b>R1<math>\bar{O}N</math></b>	Alarm 1 ON Delay	Alarm 1 must be assigned, and the alarm 1 type must not be 0, 12, or 13.
<b>R2<math>\bar{O}N</math></b>	Alarm 2 ON Delay	Alarm 2 must be assigned, and the alarm 2 type must not be 0, 12, or 13.
<b>R3<math>\bar{O}N</math></b>	Alarm 3 ON Delay	Alarm 3 must be assigned, and the alarm 3 type must not be 0, 12, or 13.
<b>R4<math>\bar{O}N</math></b>	Alarm 4 ON Delay	Alarm 4 must be assigned, and the alarm 4 type must not be 0, 12, or 13.

The alarm 1, 2, 3, or 4 output is prevented from turning ON until after the delay times set in these parameters have elapsed.



Function

- Set the time for which the ON delay is to be enabled.
- To disable the ON delay, set 0.



Setting

Setting range	Unit	Default
0 to 999	Seconds	0



See

#### ● Related Parameters

Alarm 1 to 4 Type (Initial Setting Level): Page 6-66

<b><i>R1OF</i></b>	Alarm 1 OFF Delay	Alarm 1 must be assigned, and the alarm 1 type must not be 0, 12, or 13.
<b><i>R2OF</i></b>	Alarm 2 OFF Delay	Alarm 2 must be assigned, and the alarm 2 type must not be 0, 12, or 13.
<b><i>R3OF</i></b>	Alarm 3 OFF Delay	Alarm 3 must be assigned, and the alarm 3 type must not be 0, 12, or 13.
<b><i>R4OF</i></b>	Alarm 4 OFF Delay	Alarm 4 must be assigned, and the alarm 4 type must not be 0, 12, or 13.

The alarm 1, 2, 3, or 4 output is prevented from turning OFF until after the delay times set in these parameters have elapsed.



Function

- Set the time for which the OFF delay is to be enabled.
- To disable the OFF delay, set 0.



Setting

Setting range	Unit	Default
0 to 999	Seconds	0



See

#### ● Related Parameters

Alarm 1 to 4 Type (Initial Setting Level): Page 6-66

***MANE*** Manual Output Method

Control must be set to 2-PID control.  
A Position-proportional Model set to Close Control with the Direct Setting of Position-proportional MV parameter set to ON must be used.



Function

If this parameter is set to HOLD when control moves from Automatic Mode to Manual Mode, the final MV from Automatic Mode will be used as the initial manual MV. If this parameter is set to INT, the setting of the Manual MV Initial Value parameter will be used as the initial manual MV.



Setting

Setting range	Default
<i>HOLD</i> : HOLD, <i>INIT</i> : INIT	<i>HOLD</i>



See

#### ● Related Parameters

Manual MV Initial Value (Advanced Function Setting Level): 6-93

**MANV**

Manual MV Initial Value

Control must be set to 2-PID control.  
A Position-proportional Model set to Close Control with the Direct Setting of Position-proportional MV parameter set to ON must be used.



Function

This parameter sets the initial value of the manual MV to use after control moves from Automatic Mode to Manual Mode.



Setting

Setting range	Unit	Default
Standard control and position-proportional control: -5.0 to 105.0	%	0.0
Heating/cooling control: -105.0 to 105.0		

If the Manual MV Limit Enable parameter is set to ON, the setting range will be the MV lower limit to the MV upper limit.



See

### ● Related Parameters

Manual Output Method (Advanced Function Setting Level): Page 6-92

Manual MV Limit Enable (Advanced Function Setting Level): Page 6-101

**RL**

RT

Control must be set to 2-PID control. If the input type is set for a temperature input, either the Standard or Heating/Cooling parameter must be set to standard control or, if the Standard or Heating/Cooling parameter is set to heating/cooling control, the Heating/Cooling Tuning Method parameter must not be set to air or water cooling.  
Or, a Position-proportional Model must be used.

This parameter executes robust tuning (RT).



Function

- When autotuning is executed with RT selected, PID constants are automatically set that make it hard for control performance to degenerate even when control object's characteristics change.
- Even when hunting occurs for PID constants when auto-tuning is executed in normal mode, it is less likely to occur when auto-tuning is executed in RT Mode.



Setting

Setting range	Default
$\bar{\alpha}N$ : RT function ON, $\bar{\alpha}FF$ : RT function OFF	$\bar{\alpha}FF$

Note: The Integral/Derivative Time Unit parameter changes to 0.1 when the RT (Robust Tuning) parameter is changed from OFF to ON.



See

### ● Related Parameters

AT Execute/Cancel (Adjustment Level): Page 6-27

Proportional Band, Integral Time, and Derivative Time (Adjustment Level): Page 6-36

PID\*Proportional band, PID\*Integral time, PID\*Derivative time (PID setting level): Page 6-46

Proportional Band (Cooling), Derivative Time (Cooling), and Integral Time (Cooling) (Adjustment Level): Page 6-37

PID ON/OFF (Initial Setting Level): Page 6-63

Integral/Derivative Time Unit (Advanced Function Setting Level): Page 6-86

**HSU****HS Alarm Use****HB and HS alarms must be supported.**

- Set this parameter to use HS alarms.



Setting range	Default
$\bar{0}N$ : Enabled, $\bar{0}FF$ : Disabled	$\bar{0}N$

**HSL****HS Alarm Latch****HB and HS alarms must be supported.  
The HS Alarm Use parameter must be set to ON.**

- When this parameter is set to ON, the HS alarm is held until any of the following conditions is satisfied.
  - a The HS alarm current is set to 50.0 A.
  - b The power is cycled.
  - c The latch is cancelled by the PF Key.  
(PF Setting = LAT: Alarm Latch Cancel)
  - d The latch is cancelled by an event input.  
(Event Input Assignment 1 to 6 = LAT: Alarm Latch Cancel)
- Output is turned OFF when switching to the Initial Setting Level, Communications Setting Level, Advanced Function Setting Level, or Calibration Level.



Setting range	Default
$\bar{0}N$ : Enabled, $\bar{0}FF$ : Disabled	$\bar{0}FF$



- **Related Parameters**

HS Alarm Use (Advanced Function Setting Level): Page 6-94  
 Event Input Assignment 1 to 6 (Initial Setting Level): Page 6-74  
 HB ON/OFF (Advanced Function Setting Level): Page 6-84  
 PF Setting (Advanced Function Setting Level): Page 6-105

**HS****HS Alarm Hysteresis**

HB and HS alarms must be supported.  
 The HS Alarm Use parameter must be set to ON.  
 The HS Alarm Latch parameter must be set to OFF.



- This parameter sets the hysteresis for HS alarms.



Setting range	Unit	Default
0.1 to 50.0	A	0.1



- Related Parameters**

HS Alarm Use (Advanced Function Setting Level): Page 6-94

**LBA****LBA Detection Time**

A Standard Model must be used.  
 Alarm 1 must be assigned.  
 The alarm type must be set to 12 (LBA).  
 ON/OFF control must be used.

This parameter enables or disables the LBA function and sets the detection time interval.



- To disable the LBA function, set 0.



Setting range	Unit	Default
0 to 9999	Seconds	0



- Related Parameters**

Alarm 1 to 4 Type (Initial Setting Level): Page 6-66

LBA Level (Advanced Function Setting Level): Page 6-96

LBA Band (Advanced Function Setting Level): Page 6-96

**LbAL** LBA Level

**A Standard Model must be used.**  
**Alarm 1 must be assigned.**  
**The alarm type must be set to 12 (LBA).**  
**The LBA detection time must not be 0.**



Function

- This parameter sets the LBA level.
- If the deviation between the SP and PV exceeds the LBA level, a loop burnout is detected.
- \* For ON/OFF control, the LBA Detection Time parameter (advanced function setting level) must not be set to 0.  
For 2-PID control, the LBA Detection Time parameter must not be set to 0 for any of PID sets 1 to 8.



Setting

	Setting range	Unit	Default
Temperature input	0.1 to 999.9	°C or °F	8.0
Analog input	0.01 to 99.99	%FS	10.00



See

### ● Related Parameters

Process Value/Set Point (Operation Level): Page 6-8  
 Alarm 1 to 4 Type (Initial Setting Level): Page 6-66  
 PID\*LBA detection time (PID setting level): Page 6-49  
 LBA Detection Time (Advanced Function Setting Level): Page 6-95  
 LBA Band (Advanced Function Setting Level): Page 6-96

**LbAb** LBA Band

**A Standard Model must be used.**  
**Alarm 1 must be assigned.**  
**The alarm type must be set to 12 (LBA).**  
**The LBA detection time must not be 0.**



Function

- This parameter sets the LBA band.
- If a control deviation greater than the LBA band is not reduced when the LBA level is exceeded, an loop burnout is detected.
- \* For ON/OFF control, the LBA Detection Time parameter (advanced function setting level) must not be set to 0.  
For 2-PID control, the LBA Detection Time parameter must not be set to 0 for any of PID sets 1 to 8.



Setting

	Setting range	Unit	Default
Temperature input	0.0 to 999.9	°C or °F	3.0
Analog input	0.00 to 99.99	%FS	0.20



See

### ● Related Parameters

Process Value/Set Point (Operation Level): Page 6-8  
 Alarm 1 to 4 Type (Initial Setting Level): Page 6-66  
 PID\*LBA detection time (PID setting level): Page 6-49  
 LBA Detection Time (Advanced Function Setting Level): Page 6-95  
 LBA Level (Advanced Function Setting Level): Page 6-96



**OUT1** Control Output 1 Assignment A Standard Model must be used.

**OUT2** Control Output 2 Assignment A Standard Model with two control outputs must be used.



Function

- These parameters set the function to assign to control outputs 1 and 2.



Setting

Setting range		Default
<i>NONE</i> :	Disabled	Control Output 1 Assignment: <i>o</i>
<i>o</i> :	Control output (heating)	Control Output 2 Assignment: <i>NONE</i> *4
<i>l-o</i> :	Control output (cooling)*1	
<i>ALM1</i> :	Alarm 1*2	
<i>ALM2</i> :	Alarm 2*2	
<i>ALM3</i> :	Alarm 3*2	
<i>ALM4</i> :	Alarm 4*2	
<i>HA</i> :	Heater alarm*2	
<i>HB</i> :	HB alarm*2	
<i>HS</i> :	HS alarm*2	
<i>S.ERR</i> :	Input error*2	
<i>P.END</i> :	Program end output*2	
<i>STG</i> :	Stage output*2	
<i>RUN</i> :	RUN output*2	
<i>TS1</i> :	Time signal 1 output*2	
<i>TS2</i> :	Time signal 2 output*2	
<i>ALM</i> :	Integrated Alarm*2	
<i>WR1</i> :	Work bit 1*2*3	
<i>WR2</i> :	Work bit 2*2*3	
<i>WR3</i> :	Work bit 3*2*3	
<i>WR4</i> :	Work bit 4*2*3	
<i>WR5</i> :	Work bit 5*2*3	
<i>WR6</i> :	Work bit 6*2*3	
<i>WR7</i> :	Work bit 7*2*3	
<i>WR8</i> :	Work bit 8*2*3	

\*1 If *l-o* is assigned for standard control, a value equivalent to 0% is output.

\*2 Can be selected for relay and voltage outputs (for driving SSR) only.

\*3 WR1 to WR8 are not displayed when the logic operation function is not used.

\*4 If the Standard or Heating/Cooling parameter is set to heating/cooling control, control automatically switches to *l-o*.

<b>SUB1</b>	<b>Auxiliary Output 1 Assignment</b>	<b>There must be an auxiliary output 1.</b>
<b>SUB2</b>	<b>Auxiliary Output 2 Assignment</b>	<b>There must be an auxiliary output 2.</b>
<b>SUB3</b>	<b>Auxiliary Output 3 Assignment</b>	<b>There must be an auxiliary output 3.</b>
<b>SUB4</b>	<b>Auxiliary Output 4 Assignment</b>	<b>There must be an auxiliary output 4.</b>

- These parameters set the function to assign to auxiliary outputs 1 to 4.

Setting range		Default
<i>NONE</i> :	Disabled	Auxiliary Output 1 Assignment: <i>ALM1</i> <sup>*4</sup>
<i>o</i> :	Control output (heating)	Auxiliary Output 2 Assignment: <i>ALM2</i> <sup>*2</sup>
<i>[-o]</i> :	Control output (cooling) <sup>*1</sup>	Auxiliary Output 3 Assignment: <i>ALM3</i> <sup>*2</sup>
<i>ALM1</i> :	Alarm 1	Auxiliary Output 4 Assignment: <i>ALM4</i> <sup>*2</sup>
<i>ALM2</i> :	Alarm 2	
<i>ALM3</i> :	Alarm 3	
<i>ALM4</i> :	Alarm 4	
<i>HA</i> :	Heater alarm	
<i>Hb</i> :	HB alarm	
<i>HS</i> :	HS alarm	
<i>S.ERR</i> :	Input error	
<i>P.END</i> :	Program end output	
<i>STG</i> :	Stage output	
<i>RUN</i> :	RUN output	
<i>TS1</i> :	Time signal 1 output	
<i>TS2</i> :	Time signal 2 output	
<i>ALM</i> :	Integrated Alarm	
<i>WR1</i> :	Work bit 1 <sup>*3</sup>	
<i>WR2</i> :	Work bit 2 <sup>*3</sup>	
<i>WR3</i> :	Work bit 3 <sup>*3</sup>	
<i>WR4</i> :	Work bit 4 <sup>*3</sup>	
<i>WR5</i> :	Work bit 5 <sup>*3</sup>	
<i>WR6</i> :	Work bit 6 <sup>*3</sup>	
<i>WR7</i> :	Work bit 7 <sup>*3</sup>	
<i>WR8</i> :	Work bit 8 <sup>*3</sup>	

\*1 If *[-o]* is assigned for standard control, a value equivalent to 0% will be output.

\*2 If heating/cooling control is used with an E5CC-T Controller that does not have control output 2, *[-o]* is automatically assigned to auxiliary output 2. If heating/cooling control is used with an E5EC-T/AC-T Controller that does not have control output 2, *[-o]* is automatically assigned to auxiliary output 4.

\*3 WR1 to WR8 are not displayed when the logic operation function is not used.

\*4 If the Controller is equipped with HB/HS alarm detection, it is set by default to *HA* (Heater Alarm).

**ALMA****Integrated Alarm Assignment**

The integrated alarm must be assigned.



You can use the integrated alarm to output an OR of alarm 1, alarm 2, alarm 3, alarm 4, the HB alarm, the HS alarm, the input alarm. Set this parameter to the sum of the codes of the status for which to output an OR.

The default is 49 (i.e., an OR of alarm 1, the HB alarm, and the HS alarm is output). The alarm 1 code is 1, the HB alarm code is 16, and the HS alarm code is 32:  $1 + 16 + 32 = 49$ .



Code	Status
+1	Alarm 1
+2	Alarm 2
+4	Alarm 3
+8	Alarm 4
+16	HB alarm
+32	HS alarm
+64	Input error

Setting range	Default
0 to 255	49



- **Related Parameters**

Alarm Value 1 to 4 (Operation Level): Page 6-20

MV at Error (Adjustment Level): Page 6-39

HB ON/OFF (Advanced Function Setting Level): Page 6-84

HS Alarm Use (Advanced Function Setting Level): Page 6-94

**ALSP****Alarm SP Selection**

Alarms 1, 2, 3, and 4 must be assigned.

The Alarm Type parameter must be set to 1, 2, 3, 4, 5, 6, 7, 14, or 15.

This parameter sets whether to use the present SP or the segment SP as the SP that triggers a deviation alarm during ramp segment operation.



Setting range	Default
$SP-M$ : Present SP, $\&SP$ : Segment SP	$SP-M$



- **Related Parameters**

4-7 Setting Programs (page 4-27)

**SPTR** SP Tracking



Function

- This parameter sets the operation to perform when moving from Program SP Mode to Fixed SP Mode.
- When this parameter is turned ON, operation continues using the program SP as the fixed SP.
- When this parameter is OFF, the fixed SP is not affected by the program SP.



Setting

Setting range	Default
$\bar{0}N$ : Enabled or $\bar{0}FF$ : Disabled	$\bar{0}FF$

● **Related Parameters**



SP Mode (Adjustment Level): Page 6-28

**PdL**  
**PdH**

PID Set Automatic Selection Data

PID Set Automatic Selection

Hysteresis

Control must be set to 2-PID control.



Function

- These parameters set data for automatic selection of the PID set.
- The PID set number to use is automatically selected according to the values set for the PID Set Automatic Selection Data parameter. The change range is specified in the PID Set Automatic Selection Range Upper Limit parameter.
- The PID Set Automatic Selection Hysteresis parameter sets hysteresis to prevent chattering when changing the PID set.



Setting

Parameter	Setting range	Unit	Default
PID Set Automatic Selection Data	$PV$ : PV $dV$ : Deviation $SP$ : SP	---	$PV$
PID Set Automatic Selection Hysteresis	0.10 to 99.99	%FS	0.50

● **Related Parameters**



PID \* Automatic Selection Range Upper Limit (PID Setting Level): Page 6-49

PID Set No. (PID Setting Level): Page 6-20

**P-db** PV Dead Band**A Position-proportional Model must be used.**

Function

When the PV enters the PV dead band, any unnecessary output is stopped to prevent the valve from deteriorating.

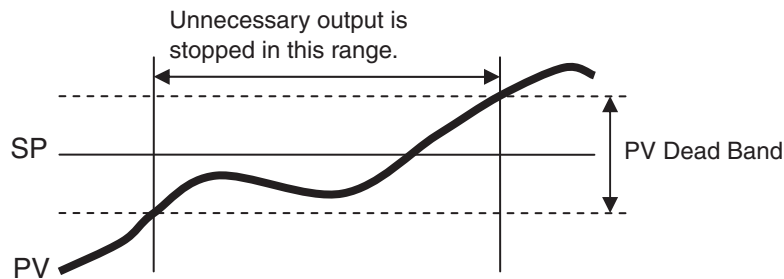

Setting

Setting range	Unit	Default
0 to 9999	EU	0



See

- **Related Parameters**

Close/Floating, Motor Calibration, and Travel Time (Initial Setting Level): Page 6-75

Position Proportional Dead Band (Adjustment Level): Page 6-41

Open/Close Hysteresis (Adjustment Level): Page 6-42

**MANL** Manual MV Limit Enable**Control must be set to 2-PID control.****Close control must be used (Position-proportional Model).**

Function

- This parameter sets whether the MV Upper Limit and MV Lower Limit parameters are to be enabled for manual MV in Manual Mode.



Setting

Setting range	Default
$\bar{a}N$ : Enabled, $\bar{a}FF$ : Disabled	$\bar{a}FF$



See

- **Related Parameters**

MV Upper Limit (Adjustment Level): Page 6-40

MV Lower Limit (Adjustment Level): Page 6-40

PID\*MV upper limit, PID\*MV lower limit (PID setting level): Page 6-46

**PMVd****Direct Setting of Position Proportional MV****Close control must be used (Position-proportional Model).**

- The Direct Setting of Position Proportional MV parameter can be set to ON to enable specifying the valve open with the MV at Stop, MV at PV Error, and Manual MV parameters.



Setting range	Default
$\bar{a}N$ : Enabled, $\bar{a}FF$ : Disabled	$\bar{a}FF$



- Related Parameters**

- MV at Reset and MV at Error (Adjustment Level): Page 6-39
- PV/MV (Manual MV) (Manual Control Level): Page 6-53

**PV RP****PV Rate of Change Calculation Period****Alarms 1, 2, 3, and 4 must be assigned. The alarm type must be set to 13.**

- The change width can be found for PV input values in any set period. Differences with previous values in each set period are calculated, and an alarm is output if the results exceed the alarm value.
- The PV rate of change calculation period can be set in units of 50 ms (sampling period).



Setting range	Unit	Default
1 to 999	Sampling cycle	20 (1 s)



- Related Parameters**

- Process Value/Set Point (Operation Level): Page 6-8
- Alarm 1 to 4 Type (Initial Setting Level): Page 6-66

**HCEM****Heating/Cooling Tuning Method****The control must be set to heating/cooling control and 2-PID control.**

Function



Setting

This parameter sets the tuning method that is suitable for the cooling control characteristics.

Setting range	Default
0: Same as heating control	0
1: Linear	
2: Air cooling	
3: Water cooling	

- **Air Cooling/Water Cooling**  
Control that is suitable for an application that does not have linear cooling characteristics (such as plastic molding machines) is performed. The response is fast and the response characteristics are stable.
- **Linear**  
Control that is suitable for an application that has linear cooling characteristics is performed.

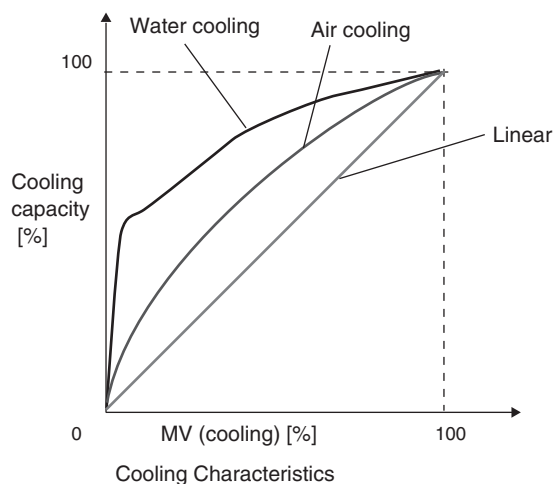

**OMPW**

**Minimum Output ON/OFF Band**

**A Standard Model must be used.  
The control must be set to 2-PID control.  
The heating and cooling control outputs must be assigned.**



Function

This parameter sets the minimum ON/OFF width of the outputs that are assigned for the heating and cooling control outputs. You can set this parameter to prevent deterioration of a relay output.



Setting

Setting range	Unit	Default
0.0 to 50.0	%	1.0

**LCTM**

**LCT Cooling Output Minimum ON Time**

**The control output on the cooling side must be a relay or voltage output.  
Heating/cooling control must be used, 2-PID control must be used, and the Heating/Cooling Tuning Method parameter must be set to air or water cooling.**



Function

- This parameters sets the minimum output ON time for the cooling-side control output during autotuning.
- Set the time in seconds that is required for the operation of the actuator that is connected to the cooling-side control.

Example: The following calculation is used when the configuration consists of a relay output, a relay, and a solenoid valve.

$$(0.02 \text{ s (fixed)} + 0.02 \text{ s} + 0.06 \text{ s}) \times 2 \text{ (safety factor)} = 0.2 \text{ s}$$

- \* The default setting of this parameter is based on the operating time of an actuator on a standard extruder.



Setting

Setting range	Unit	Default
0.1 to 1.0	Seconds	0.2



## PF PF Setting



Function

- This parameter sets the function of the PF Key.



Setting

- The default is SHFT (Digit Shift).

Set value	Setting	Function
OFF: $\bar{O}FF$	Disabled	Does not operate as a function key.
RUN: $RUN$	RUN	Specifies RUN status.
RST: $RSt$	Reset	Specifies Reset status.*1
R-R: $R-R$	Reverse Run/Reset	Specifies reversing operation status between Run and Reset.*1
HOLD: $H\bar{O}Ld$	Reverse Hold/Clear Hold	Specifies reversing operation status between Hold and Hold Clear.
ADV: $Adv$	Advance	Specifies performing advance operation.
AT-2: $At-2$	100%AT Execute/Cancel	Specifies reversing 100% AT Execute/Cancel status. *2
AT-1: $At-1$	40%AT Execute/Cancel	Specifies reversing 40% AT Execute/Cancel status. *2 *3
ATA2: $AtAR2$	All PID 100% AT Execute/Cancel	Specifies reversing 100% AT execute/cancel status for all PID sets.*2
ATA1: $AtAR1$	All PID 40% AT Execute/Cancel	Specifies reversing 40% AT execute/cancel status for all PID sets.*2 *3
LAT: $LAt$	Alarm Latch Cancel	Specifies canceling alarm latches. *4
A-M: $A-M$	Auto/Manual	Specifies reversing Auto/Manual status. *5
PFDP: $PFdP$	Monitor/Setting Item	Specifies the monitor/setting item display. Select the monitor/setting item using the Monitor/Setting Item 1 to 5 parameters (Advanced Function Setting Level).
SHIFT: $SHFt$	Digit Shift	Operates as a Digit Shift Key when settings are being changed.

- \*1 The reset operation for a Reset or Reverse Run/Reset setting is implemented by pressing the PF Key for at least two seconds. The Run operation is implemented by pressing the PF Key for at least one second.
- \*2 When AT cancel is specified, it means that auto-tuning is cancelled regardless of the type of auto-tuning that is currently being executed.
- \*3 AT-1 or ATA1 can be set for heating/cooling control or position-proportional (floating) control, but the function is disabled.
- \*4 Alarms 1 to 4, the HB alarm, and the HS alarm are cancelled.
- \*5 For details on auto/manual operations using the PF Key, refer to 5-11 *Performing Manual Control*.
- \* Operation will be performed according to the setting of this parameter when the PF Key is pressed for at least one second. (This does not apply to the reset operation when Reverse Run/Reset is set.) If Monitor/Setting Items is selected, the display will switch between monitor/setting items 1 to 5 each time the key is pressed.
- \* The PF Key is enabled only when the PF Key Protect parameter is set to OFF.



See

### ● Related Parameters

Monitor/Setting Item 1 to 5 (Advanced Function Setting Level): Page 6-106

**PFd1** PF Monitor/Setting Item Display 1

**PFd2** PF Monitor/Setting Item Display 2

**PFd3** PF Monitor/Setting Item Display 3

The PF Setting parameter must be set to PFDP.

**PFd4** PF Monitor/Setting Item Display 4

**PFd5** PF Monitor/Setting Item Display 5



Function

- When the PF Key is set to display monitor/setting items, pressing the PF Key will display in order the contents of the Monitor/Setting Item 1 to 5 parameters. The contents of these parameters are shown in the following table. Refer to the relevant parameters for the setting/monitor ranges.

Set value	Setting	Remarks	
		Monitor/Setting	Display
0	Disabled		---
1	PV/SP/Program No. Monitor and Segment No. Monitor	Can be set. (SP) <sup>*1</sup>	---
2	PV/SP/MV (valve opening for Position-proportional Models)	Can be set. (SP) <sup>*1</sup>	---
3	PV/SP/MV (Cooling)	Can be set. (SP) <sup>*1</sup>	---
4	PV/SP/Remaining Segment Time	Can be set. (SP) <sup>*1</sup>	---
5	Program Number	Can be set.	PRG
6	Segment No. Monitor	Cannot be set.	SEG
7	Remaining Standby Time Monitor	Cannot be set.	StbM
8	Elapsed Program Time Monitor	Cannot be set.	PRGt
9	Remaining Program Time Monitor	Cannot be set.	PRGR
10	Elapsed Segment Time Monitor	Cannot be set.	SEGt
11	Remaining Segment Time Monitor	Cannot be set.	SEGR
12	Program Execution Repetitions Monitor	Cannot be set.	RPEM
13	Proportional band	Can be set.	P <sup>*2</sup>
14	Integral time	Can be set.	I <sup>*2</sup>
15	Derivative time	Can be set.	D <sup>*2</sup>
16	Proportional Band (Cooling)	Can be set.	[ - P <sup>*2</sup>
17	Integral Time (Cooling)	Can be set.	[ - I <sup>*2</sup>
18	Derivative Time (Cooling)	Can be set.	[ - D <sup>*2</sup>
19	Alarm value 1 <sup>*3</sup>	Can be set.	RL - 1
20	Alarm value upper limit 1 <sup>*3</sup>	Can be set.	RL 1H
21	Alarm value lower limit 1 <sup>*3</sup>	Can be set.	RL 1L
22	Alarm value 2 <sup>*3</sup>	Can be set.	RL - 2
23	Alarm value upper limit 2 <sup>*3</sup>	Can be set.	RL 2H
24	Alarm value lower limit 2 <sup>*3</sup>	Can be set.	RL 2L
25	Alarm value 3 <sup>*3</sup>	Can be set.	RL - 3
26	Alarm value upper limit 3 <sup>*3</sup>	Can be set.	RL 3H
27	Alarm value lower limit 3 <sup>*3</sup>	Can be set.	RL 3L
28	Alarm value 4 <sup>*3</sup>	Can be set.	RL - 4
29	Alarm value upper limit 4 <sup>*3</sup>	Can be set.	RL 4H
30	Alarm value lower limit 4 <sup>*3</sup>	Can be set.	RL 4L

- \*1 With the E5CC-T, only the PV and SP can be displayed. The SP can be selected only in Fixed SP Mode.
- \*2 The setting for the currently selected PID set number is displayed.
- \*3 The settings for the currently selected program number is displayed.

**SPd1** PV/SP No. 1 Display Selection**SPd2** PV/SP No. 2 Display Selection

These parameters set the items to display on the No. 1 display, No. 2 display, and No. 3 display.



Set value	No. 1 display	No. 2 display	No. 3 display (E5EC-T/E5AC-T only)
0	Nothing is displayed.	Nothing is displayed.	Nothing is displayed.
1	Process value	Set point	Nothing is displayed.
2	Process value	Nothing is displayed.	Nothing is displayed.
3	Set point	SP (character display)	Nothing is displayed.
4	Process value	Set point	MV (valve opening for Position-proportional Models)
5	Process value	Set point	MV monitor (cooling)
6	Process value	Set point	Program number and segment number
7	Process value	Set point	Remaining segment time

Parameter	Setting range	Default
PV/SP No. 1 Display Selection	0 to 7	6
PV/SP No. 2 Display Selection		E5CC-T: 0 E5EC-T/E5AC-T: 7

## PV St PV Status Display Function



- This parameter sets a control or alarm status that is displayed alternately in 0.5-s cycles on the No. 1 display when the PV is set to be displayed in the No. 1 display.
- PV
- PV/SP\*
- PV/Manual MV (Valve Opening)
- PV/SP/Manual MV (Valve Opening)
  - \* This includes when the PV/SP is selected for the Monitor/Setting Item parameter.



Setting range	Default
<i>OFF</i> : No PV status display	<i>OFF</i>
<i>MANU</i> : MANU is alternately displayed during manual control.	
<i>RSt</i> : RST is alternately displayed while resetting.	
<i>ALM1</i> : ALM1 is alternately displayed during Alarm 1 status.	
<i>ALM2</i> : ALM2 is alternately displayed during Alarm 2 status.	
<i>ALM3</i> : ALM3 is alternately displayed during Alarm 3 status.	
<i>ALM4</i> : ALM4 is alternately displayed during Alarm 4 status.	
<i>ALM</i> : ALM is alternately displayed when Alarm 1, 2, 3, or 4 is set to ON.	
<i>HA</i> : HA is alternately displayed when an HB alarm or HS alarm is ON.	
<i>Stb</i> : STB is alternately displayed during standby status.	



### ● Related Parameters

Process Value/Set Point (Operation Level): Page 6-8

PV/MV (Manual MV) (Manual Control Level): Page 6-53

## SVSt SV Status Display Function



Function

- This parameter sets a control or alarm status that is displayed alternately in 0.5-s cycles on the No. 2 display when the PV is set to be displayed in the No. 1 display.
  - PV
  - PV/SP\*
  - PV/Manual MV (Valve Opening)
  - PV/SP/Manual MV (Valve Opening)
- \* This includes when the PV/SP is selected for the Monitor/Setting Item parameter.



Setting

Setting range	Default
<i>OFF</i> : No SV status display	<i>OFF</i>
<i>MANU</i> : MANU is alternately displayed during manual control.	
<i>RSt</i> : RST is alternately displayed while resetting.	
<i>ALM1</i> : ALM1 is alternately displayed during Alarm 1 status.	
<i>ALM2</i> : ALM2 is alternately displayed during Alarm 2 status.	
<i>ALM3</i> : ALM3 is alternately displayed during Alarm 3 status.	
<i>ALM4</i> : ALM4 is alternately displayed during Alarm 4 status.	
<i>ALM</i> : ALM is alternately displayed when Alarm 1, 2, 3, or 4 is set to ON.	
<i>HR</i> : HA is alternately displayed when an HB alarm or HS alarm is ON.	
<i>Stb</i> : STB is alternately displayed during standby status.	



See

### ● Related Parameters

- Process Value/Set Point (Operation Level): Page 6-8
- PV/MV (Manual MV) (Manual Control Level): Page 6-53

## d.REF Display Refresh Period



Function

- This parameter delays the display refresh period for monitor values. Only display refreshing is delayed, and the refresh period for process values used in control is not changed.
- This function is disabled by setting the parameter to OFF.



Setting

Setting range	Unit	Default
OFF, 0.25, 0.5, 1.0	Seconds	0.25

## ***bURN*** Burnout Method



- This parameter specifies whether the input value when an input error occurs is to be treated as the upper limit or the lower limit.
- The setting of this parameter applies to alarms, a PV transfer output, or automatic PID set selection with the PV/DV.



Setting range	Default
UP: Up-scale, DOWN: Down-scale	UP

## ***PMSE*** Parameter Mask Setting



- You can use a key operation to hide parameters that do not need to be displayed.
- This allows you to prevent incorrect operations for parameters or to change the parameter display configuration according to the application.



If you set the Parameter Mask Setting parameter to ON, Parameter Mask Mode is entered. Refer to *5-7-1 Parameter Mask Settings* (page 5-21) for information on masking parameters after you enter Parameter Mask Mode.





### ● Related Parameter

Parameter Mask Enable (Protect Setting Level): Page 6-5

## ***CMOV*** Move to Calibration Level Initial setting/communications protect must be 0.

This parameter sets the password to move to the Calibration Level.



- Set the password to move to the Calibration Level. The password is 1201.
- Move to the Calibration Level either by pressing the  Key or  Key or by waiting for two seconds to elapse.



### ● Related Parameter

Initial Setting/Communications Protect (Protect Level): Page 6-4

## 6-11 Communications Setting Level

<i>PSEL</i>	Protocol Setting	
<i>U-Nō</i>	Communications Unit No.	
<i>bPS</i>	Communications Baud Rate	
<i>LEN</i>	Communications Data Length	CompoWay/F must be selected as the protocol.
<i>SbLt</i>	Communications Stop Bits	CompoWay/F must be selected as the protocol.
<i>PRtY</i>	Communications Parity	CompoWay/F or Modbus must be selected as the protocol.
<i>SdWt</i>	Send Data Wait Time	
<i>MAXU</i>	Highest Communications Unit No.	FINS or MCP4 must be selected as the protocol, or CompoWay/F must be selected as the protocol and the communications unit number must be set to 0.
<i>AREA</i>	Area	FINS or MCP4 must be selected as the protocol.
<i>AdRH</i>	First Address Upper Word	FINS or MCP4 must be selected as the protocol.
<i>AdRL</i>	First Address Lower Word	FINS or MCP4 must be selected as the protocol.
<i>RWAt</i>	Receive Data Wait Time	FINS or MCP4 must be selected as the protocol.
<i>UNLt</i>	Communications Node Number	FINS or MCP4 must be selected as the protocol, or CompoWay/F must be selected as the protocol and the communications unit number must be set to 0.
<i>UP*</i>	Upload Setting * (* = 1 to 23)	FINS or MCP4 must be selected as the protocol.
<i>dN*</i>	Download Setting * (* = 1 to 43)	FINS or MCP4 must be selected as the protocol.
<i>CōPY</i>	Copy	CompoWay/F, FINS, or MCP4 must be selected as the protocol and the communications unit number must be set to 0.



Function

- Each parameter is enabled when the power is reset.
- Match the communications specifications of the E5□C-T and the host computer. If multiple devices are connected, ensure that the communications specifications for all devices in the system (except the Communications unit number) are the same.



Setting

Item	Display	Set values	Settings	Default
Protocol setting	<i>PSEL</i>	<i>[WF</i> <i>Mod</i> <i>[MP</i> <i>FINS</i> <i>MC4</i>	CompoWay/F Modbus Component communications Host Link (FINS) MC Protocol (Type 4)	<i>[WF</i>
Communications Unit No.	<i>U-Nō</i>	0 to 99	0 to 99	<i>1</i>
Communications baud rate	<i>bPS</i>	9.6/19.2/38.4/57.6 (Kbps)	9.6/19.2/38.4/57.6 (kbps)	<i>9.6</i>
Communications data length	<i>LEN</i>	7 or 8 bits	7 or 8 bits	<i>7</i>
Stop bits	<i>Sbct</i>	1 or 2 bits	1 or 2 bits	<i>2</i>
Communications parity	<i>PRty</i>	<i>NōNE EVEN odd</i>	None, Even, Odd	<i>EVEN</i>
Send data wait time	<i>sdwt</i>	0 to 99	0 to 99 (ms)	<i>20</i>

\* The Communications Writing parameter will be automatically turned ON if the Protocol Setting parameter is set to component communications, Host Link (FINS) communications, or the MC Protocol (Type 4).



See

### ● Related Parameter

Communications Writing (Adjustment Level): Page 6-28

Refer to the *E5□C-T Digital Controllers Communications Manual* (Cat. No. H186) for details.

Protocol Setting Parameter = Host Link (FINS) or MC Protocol (Type 4)

Parameter	Parameter display	Display	Settings	Default
Highest Communications Unit No.	<i>MAXU</i>	<i>0 to 99</i>	0 to 99	0
Area	<i>AREA</i>	<i>0 to 25</i>	0 to 25	0
First Address Upper Word	<i>AdRH</i>	<i>0 to 99</i>	0 to 99	0
First Address Lower Word	<i>AdRL</i>	<i>0 to 9999</i>	0 to 9999	0
Receive Data Wait Time	<i>RWRt</i>	<i>100 to 9999</i>	100 to 9999 ms	1000
Communications Node Number	<i>UNct</i>	<i>0 to 99</i>	0 to 99	0
Upload Settings 1 to 23	<i>UP 1 to 23</i>	<i>0 to 179</i>	0 to 179	
Download Settings 1 to 43	<i>dN 1 to 43</i>	<i>30 to 179</i>	30 to 179	
Copy	<i>[ōPY</i>	<i>ōFF, ALL, 1 to 31</i>		OFF

Protocol Setting Parameter = Component Communications

Parameter	Parameter display	Display	Settings	Default
Highest Communications Unit No.	<i>MAXU</i>	<i>0 to 99</i>	0 to 99	0
Receive Data Wait Time	<i>RWRt</i>	<i>100 to 9999</i>	100 to 9999 ms	1000
Copy	<i>[ōPY</i>	<i>ōFF, ALL, 1 to 31</i>		OFF



# 7

## User Calibration

---

---

7-1	User Calibration .....	7-2
7-2	Parameter Structure .....	7-3
7-3	Thermocouple Calibration .....	7-4
7-4	Resistance Thermometer Calibration .....	7-7
7-5	Calibrating Analog Input .....	7-9
7-6	Calibrating the Transfer Output .....	7-11
7-7	Checking Indication Accuracy .....	7-13

# 7-1 User Calibration

---

The E5□C-T is correctly calibrated before it is shipped from the factory. Normally it does not need to be calibrated by the user.

If, however, it must be calibrated by the user, use the parameters for calibrating temperature input and analog input. OMRON, however, cannot ensure the results of calibration by the user. Also, calibration data is overwritten with the latest calibration results. The default calibration settings cannot be restored after user calibration. Perform user calibration with care.

## ● Calibrating Inputs

The input type selected in the parameter is used for calibration. The input types are as follows:

- Thermocouple: 16 types
- Infrared temperature sensor: 4 types
- Resistance thermometer: 5 types
- Current input: 2 types
- Voltage input: 3 types

## ● Registering Calibration Data

The new calibration data for each item is temporarily registered. It can be officially registered as calibration data only when all items have been calibrated to new values. Therefore, be sure to temporarily register all items when you perform the calibration. When the data is registered, it is also recorded that user calibration has been performed.

Prepare separate measuring devices and equipment for calibration. For details on how to handle measuring devices and equipment, refer to the respective instruction manuals.

# 7-2 Parameter Structure

- To execute user calibration, enter the password "1201" at the Move to Calibration Level parameter in the Advanced Function Setting Level. The mode will be changed to the calibration mode, and *Adj* will be displayed.
- The Move to Calibration Level parameter may not be displayed when the user is doing the calibration for the first time. If this happens, set the Initial Setting/Communications Protect parameter in the Protect Level to 0 before moving to the Advanced Function Setting Level.
- The calibration mode is ended by turning the power OFF.
- The parameter calibrations in the calibration mode are structured as shown below.

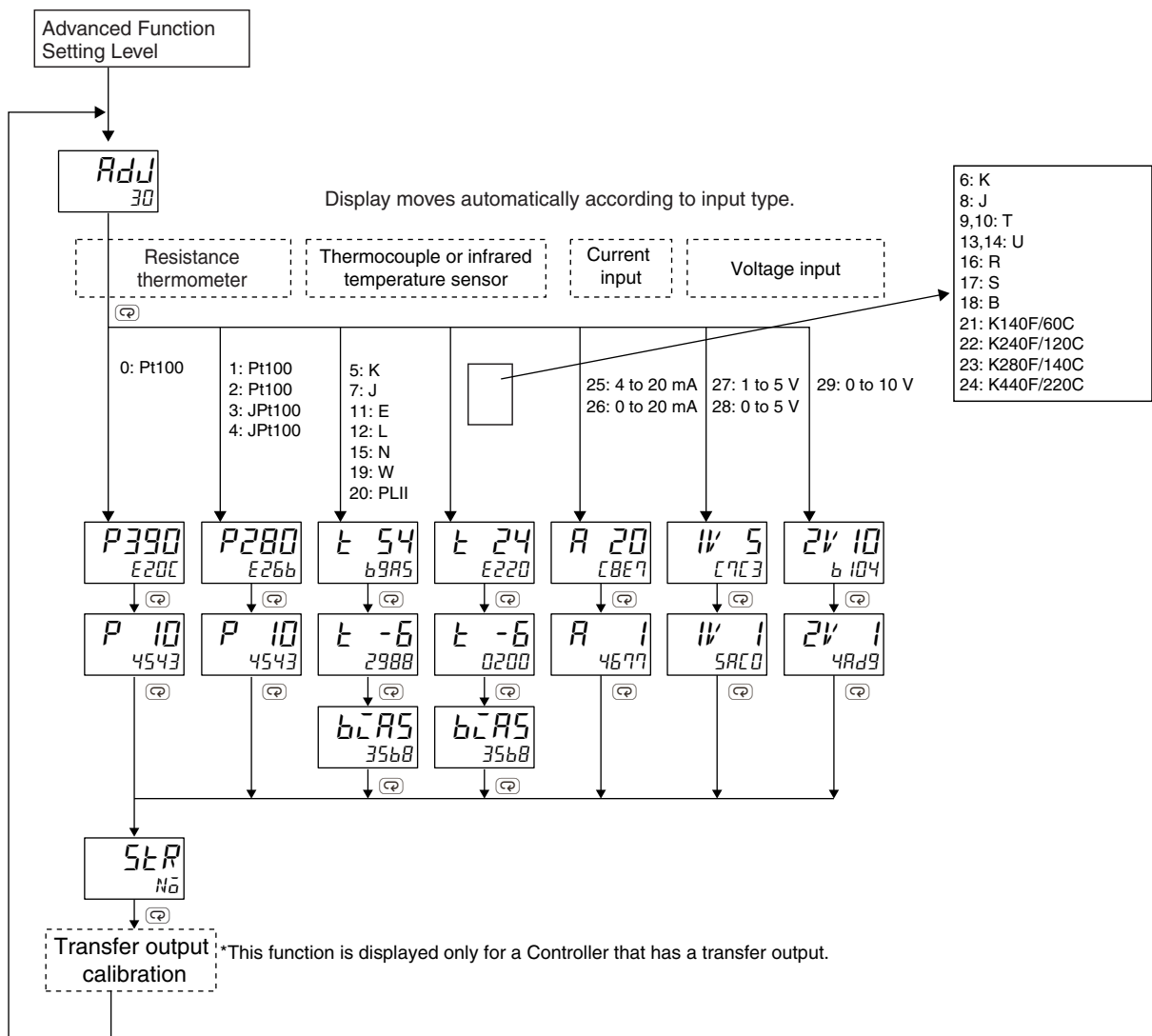

When calibration has been performed after purchase, the user calibration information shown in the following illustration will be displayed when moving to the Calibration Level.

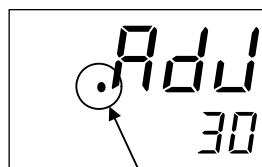

A dot is displayed.

## 7-3 Thermocouple Calibration

- Calibrate according to the type of thermocouple: thermocouple group 1 (input types 5, 7, 11, 12, 15, 19, and 20) and thermocouple group 2 (input types 6, 8, 9, 10, 13, 14, 16, 17, 18, 21, 22, 23, and 24).
- When calibrating, do not cover the bottom of the Controller. Also, do not come into contact with the input terminals (E5CC-T: terminals 5 and 6, E5EC-T/AC-T: terminals 23 and 24).

### ● Preparations

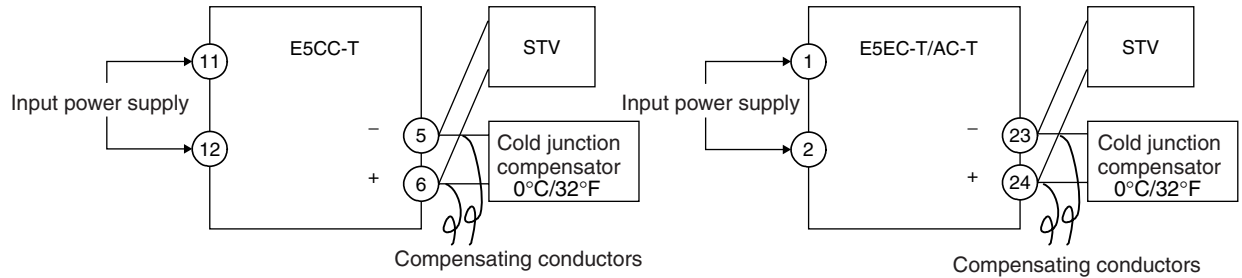

- Set the cold junction compensator designed for compensation of internal thermocouples to 0°C. Make sure that internal thermocouples are disabled (i.e., that tips are open).
- In the above figure, STV indicates a standard DC current/voltage source.
- Use the compensating conductor designed for the selected thermocouple. When thermocouples R, S, E, B, W, or PLII or an infrared temperature sensor is used, the cold junction compensator and the compensating conductor can be substituted with the cold junction compensator and the compensating conductor for thermocouple K.



### Additional Information

#### Connecting the Cold Junction Compensator

Correct process values cannot be obtained if you touch the contact ends of the compensating conductor during calibration of a thermocouple. Accordingly, short-circuit (enable) or open (disable) the tip of the thermocouple inside the cold junction compensator as shown in the figure below to create a contact or non-contact state for the cold junction compensator.

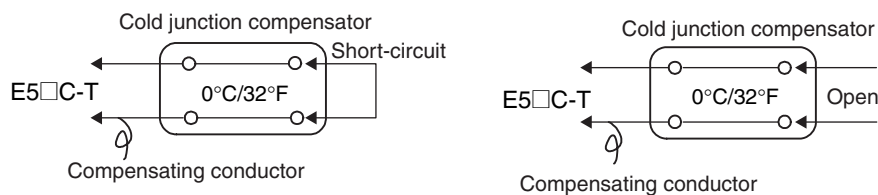

In this example, calibration is shown for a Controller with thermocouple/infrared temperature sensor set as the input type.

1. Connect the power supply.
2. Connect a standard DC current/voltage source (STV), precision digital multimeter (DMM), and contact junction compensator (e.g., a zero controller as in the figure) to the thermocouple input terminals, as shown in the figure below.

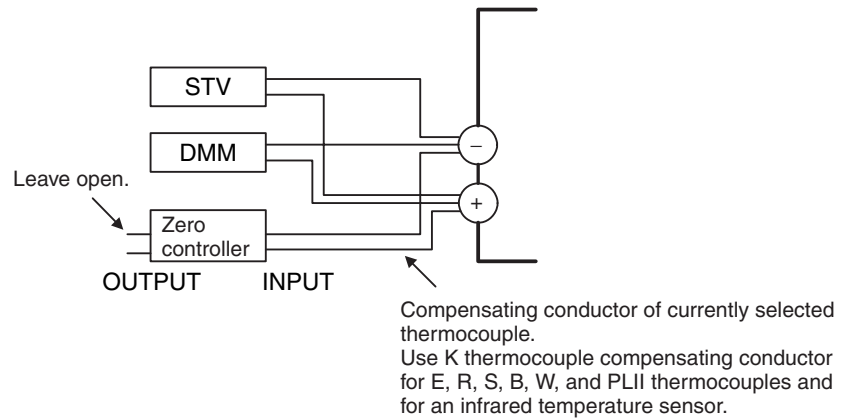

3. Turn the power ON.
4. Move to the Calibration Level.  
This starts the 30-minute aging timer. This timer provides an approximate timer for aging. After 30 minutes have elapsed, the No. 2 display changes to 0. You can advance to the next step in this procedure even if 0 is not displayed.

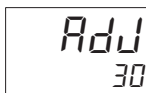

- Input types 5, 7, 11, 12, 15, 19, 20:

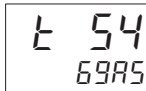

- Input types 6, 8, 9, 10, 13, 14, 16, 17, 18, 21, 22, 23, 24:

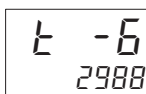
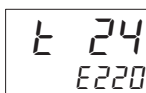

5. When the Key is pressed, the status changes as shown to the left. The No. 2 display at this time shows the currently entered count value in hexadecimal. Set the STV as follows:
  - Input types 5, 7, 11, 12, 15, 19, 20: Set to 54 mV.
  - Input types 6, 8, 9, 10, 13, 14, 16, 17, 18, 21, 22, 23, 24: Set to 24 mV.
 Allow the count value on the No. 2 display to fully stabilize, then press the Key to temporarily register the calibration settings. If this count value is outside of the specified range, the No. 2 display will flash and the count value will not be temporarily registered.
6. When the Key is pressed, the status changes as shown to the left. Set the STV to -6 mV. Allow the count value on the No. 2 display to fully stabilize, then press the Key to temporarily register the calibration settings. If this count value is outside of the specified range, the No. 2 display will flash and the count value will not be temporarily registered.

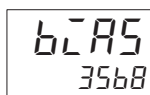

7. When the  Key is pressed, the status changes as shown to the left.

8. Change the wiring as follows:

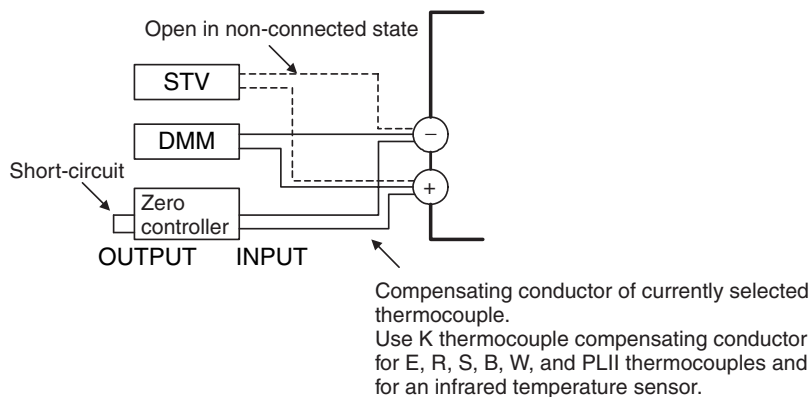



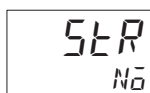

Disconnect the STV to enable the thermocouple of the cold junction compensator. When doing this, be sure to disconnect the wiring on the STV side.

9. Allow the count value on the No. 2 display to fully stabilize, then press the  Key to temporarily register the calibration settings.



10. When the  Key is pressed, the status changes as shown to the left.

The data to be temporarily registered is not displayed if it is not complete.

Press the  Key. The No. 2 display changes to 4E5. Release the key and wait two seconds or press the  Key. This stores the temporarily registered calibration data to non-volatile memory. To cancel the saving of temporarily registered calibration data to non-volatile memory, press the  Key (while No is displayed in the No. 2 display) without pressing the  Key.

11. The calibration mode is ended by turning the power OFF.

For Controllers that have a transfer output, you can continue by calibrating the transfer output. For detailed setting methods, refer to 7-6 *Calibrating the Transfer Output*.

## 7-4 Resistance Thermometer Calibration

In this example, calibration is shown for Controller with a resistance thermometer set as the input type. Use connecting wires of the same thickness

1. Connect the power supply.
2. Connect a precision resistance box (called a "6-dial variable resistor" in this manual) to the resistance thermometer input terminals, as shown in the following diagram.

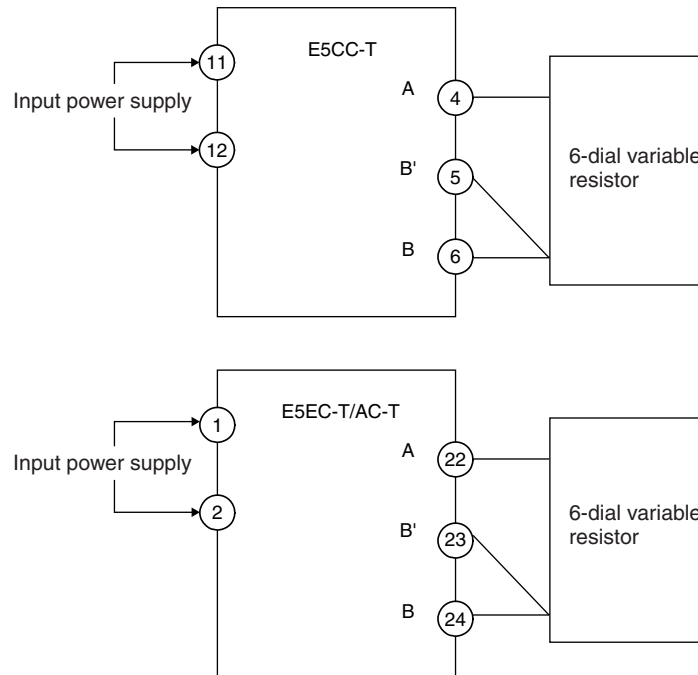

3. Turn the power ON.
4. Move to the Calibration Level.  
This starts the 30-minute aging timer. This timer provides an approximate timer for aging. After 30 minutes have elapsed, the No. 2 display changes to 0. You can advance to the next step in this procedure even if 0 is not displayed.
5. Execute calibration for the main input.  
Press the  $\square$  Key to display the count value for each input type. The No. 2 display at this time shows the currently entered count value in hexadecimal. Set the 6-dial as follows:
  - Input type 0: 390  $\Omega$
  - Input type 1, 2, 3 or 4: 280  $\Omega$
 Allow the count value on the No. 2 display to fully stabilize, then press the  $\triangleright$  Key to temporarily register the calibration settings. If this count value is outside of the specified range, the No. 2 display will flash and the count value will not be temporarily registered.
6. When the  $\square$  Key is pressed, the status changes as shown to the left.  
Set the 6-dial to 10  $\Omega$ .  
Allow the count value on the No. 2 display to fully stabilize, then press the  $\triangleright$  Key to temporarily register the calibration settings. If this count value is outside of the specified range, the No. 2 display will flash and the count value will not be temporarily registered.

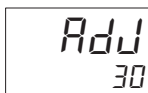



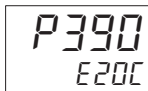

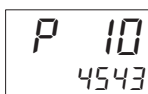
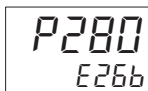

- Input type 0:

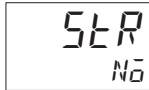

- Input types 1, 2, 3, 4:





7. When the  Key is pressed, the status changes as shown to the left. The data to be temporarily registered is not displayed if it is not complete. Press the  Key. The No. 2 display changes to *4E5*. Release the key and wait two seconds or press the  Key. This stores the temporarily registered calibration data to non-volatile memory. To cancel the saving of temporarily registered calibration data to non-volatile memory, press the  Key (while *No* is displayed in the No. 2 display) without pressing the  Key.
8. The calibration mode is quit by turning the power OFF. For Controllers that have a transfer output, you can continue by calibrating the transfer output. For detailed setting methods, refer to *7-6 Calibrating the Transfer Output*.



## 7-5 Calibrating Analog Input

### ● Calibrating a Current Input

In this example, calibration is shown for a Controller with an analog input, with a current input set as the input type.

1. Connect the power supply.
2. Connect an STV and DMM to the current input terminals, as shown in the following diagram.

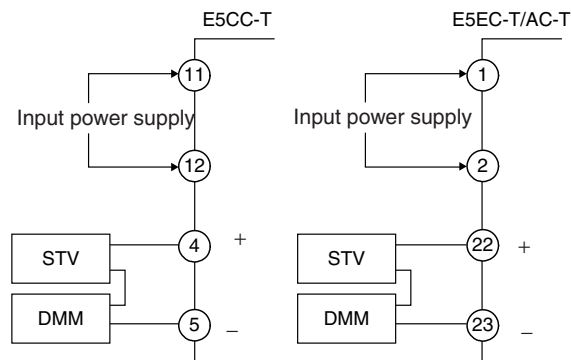

3. Turn the power ON.
4. Move to the Calibration Level.  
This starts the 30-minute aging timer. This timer provides an approximate timer for aging. After 30 minutes have elapsed, the No. 2 display changes to 0. You can advance to the next step in this procedure even if 0 is not displayed.
5. When the Key is pressed, the status changes as shown to the left.  
The No. 2 display at this time shows the currently entered count value in hexadecimal. Set the STV to 20 mA.  
Allow the count value on the No. 2 display to fully stabilize, then press the Key to temporarily register the calibration settings.  
If this count value is outside of the specified range, the No. 2 display will flash and the count value will not be temporarily registered.
6. When the Key is pressed, the status changes as shown to the left.  
Set the STV to 1 mA.  
Allow the count value on the No. 2 display to fully stabilize, then press the Key to temporarily register the calibration settings.  
If this count value is outside of the specified range, the No. 2 display will flash and the count value will not be temporarily registered.
7. When the Key is pressed, the status changes as shown to the left.  
The data to be temporarily registered is not displayed if it is not complete.  
Press the Key. The No. 2 display changes to *5E5*. Release the key and wait two seconds or press the Key. This stores the temporarily registered calibration data to non-volatile memory.  
To cancel the saving of temporarily registered calibration data to non-volatile memory, press the Key (while *N $\bar{0}$*  is displayed in the No. 2 display) without pressing the Key.
8. The calibration mode is ended by turning the power OFF.  
For Controllers that have a transfer output, you can continue by calibrating the transfer output. For detailed setting methods, refer to *7-6 Calibrating the Transfer Output*.

Adj  
30

A 20  
CBE7

A 1  
4677

5E5  
N $\bar{0}$

● **Calibrating a Voltage Input**

In this example, calibration is shown for a Controller with an analog input, with a voltage input set as the input type.

1. Connect the power supply.
2. Connect an STV and DMM to the voltage input terminals, as shown in the following diagram.

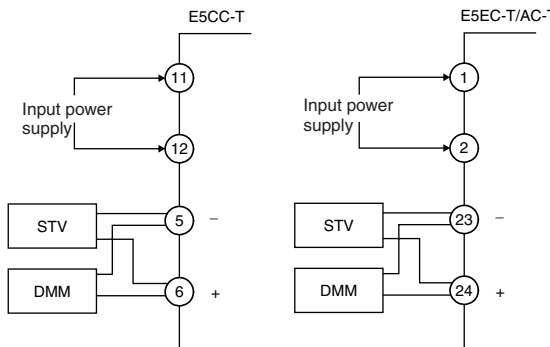

3. Turn the power ON.
4. Move to the Calibration Level.  
This starts the 30-minute aging timer. This timer provides an approximate timer for aging. After 30 minutes have elapsed, the No. 2 display changes to 0. You can advance to the next step in this procedure even if 0 is not displayed.

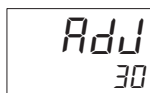

- Input type 27 or 28:

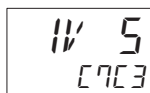

- Input type 29:

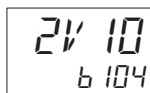

- Input type 27 or 28:



- Input type 29:

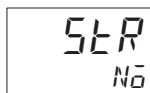
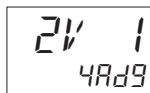

5. When the Key is pressed, the status changes as shown to the left. The No. 2 display at this time shows the currently entered count value in hexadecimal. Set the STV as follows:
  - Input type 27 or 28: 5 V
  - Input type 29: 10 V
 Allow the count value on the No. 2 display to fully stabilize, then press the Key to temporarily register the calibration settings.  
If this count value is outside of the specified range, the No. 2 display will flash and the count value will not be temporarily registered.

6. When the Key is pressed, the status changes as shown to the left. Set the STV to 1 V.

Allow the count value on the No. 2 display to fully stabilize, then press the Key to temporarily register the calibration settings.  
If this count value is outside of the specified range, the No. 2 display will flash and the count value will not be temporarily registered.

7. When the Key is pressed, the status changes as shown to the left. The data to be temporarily registered is not displayed if it is not complete. Press the Key. The No. 2 display changes to 5E5. Release the key and wait two seconds or press the Key. This stores the temporarily registered calibration data to non-volatile memory.  
To cancel the saving of temporarily registered calibration data to non-volatile memory, press the Key (while No is displayed in the No. 2 display) without pressing the Key.

8. The calibration mode is ended by turning the power OFF.  
For Controllers that have a transfer output, you can continue by calibrating the transfer output. For detailed setting methods, refer to 7-6 *Calibrating the Transfer Output*.

## 7-6 Calibrating the Transfer Output

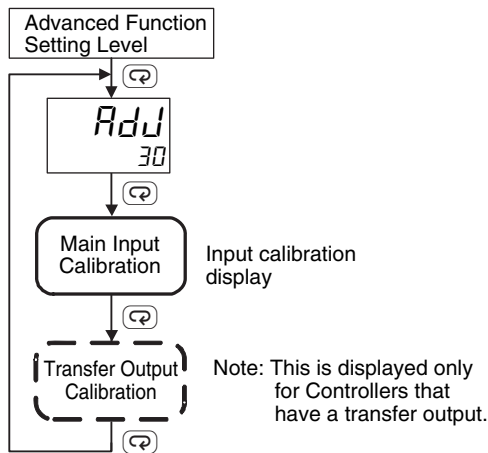

For Controllers that have a transfer output, the transfer output calibration display will be displayed after input calibration has been completed.

Use the following procedure to calibrate the transfer output for 4 to 20 mA.

1. Connect a DMM to the transfer output terminals.

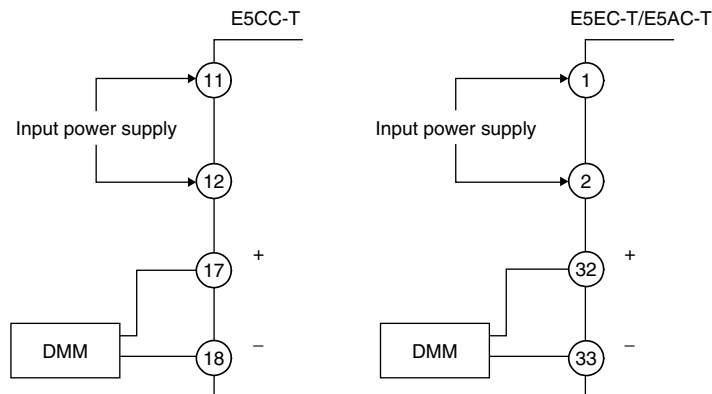

2. Press the  $\rightarrow$  Key to display the parameter for the transfer output.
3. The calibration display for 20 mA will be displayed. Press the  $\uparrow$  or  $\downarrow$  Key until the DMM monitor value changes to 20 mA. Press the  $\rightarrow$  Key. The calibration settings will be temporarily registered.
4. The calibration display for 4 mA will be displayed. Press the  $\uparrow$  or  $\downarrow$  Key until the DMM monitor value changes to 4 mA. Press the  $\rightarrow$  Key. The calibration settings will be temporarily registered.
5. To cancel saving the temporarily registered calibration data to non-volatile memory, press the  $\rightarrow$  Key without pressing the  $\uparrow$  Key, i.e., while  $N\bar{0}$  is displayed in the No. 2 display. Press the  $\uparrow$  Key. The No. 2 display changes to  $4E5$ . Release the key and wait 2 seconds or press the  $\rightarrow$  Key. This saves the temporarily registered calibration data in non-volatile memory.
6. The Calibration Mode is ended by turning OFF the power supply.

5LR  
N $\bar{0}$

A20.E  
52AC

A4.E  
0037

5LR.E  
N $\bar{0}$

Use the following procedure to calibrate the transfer output for 1 to 5 V.

1. Connect a DMM to the transfer output terminals.

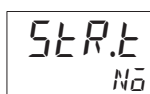
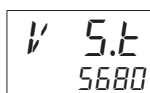
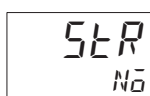
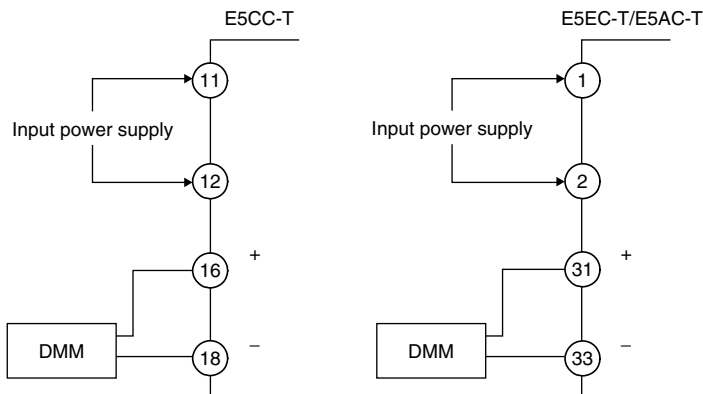

2. Press the Key to display the parameter for the transfer output.
3. The calibration display for 5 V will be displayed. Press the or Key until the DMM monitor value changes to 5 V.  
Press the Key. The calibration settings will be temporarily registered.
4. The calibration display for 1 V will be displayed. Press the or Key until the DMM monitor value changes to 1 V.  
Press the Key. The calibration settings will be temporarily registered.
5. To cancel saving the temporarily registered calibration data to non-volatile memory, press the Key without pressing the Key, i.e., while *No* is displayed in the No. 2 display.  
Press the Key. The No. 2 display changes to *5E5*. Release the key and wait 2 seconds or press the Key. This saves the temporarily registered calibration data in non-volatile memory.
6. The Calibration Mode is ended by turning OFF the power supply.

## 7-7 Checking Indication Accuracy

- After calibrating the input, be sure to check the indication accuracy to make sure that the calibration has been executed correctly.
- Operate the E5□C-T in the process value/set point monitor mode.
- Check the indication accuracy at the following three values: upper limit, lower limit, and mid-point.
- To check the range of an infrared sensor, set the input type parameter to 6 (i.e., a K thermocouple) and input a voltage that is equivalent to the starting power of a K thermocouple.

### ● Thermocouple or Infrared Temperature Sensor

- Preparations

The diagram below shows the required device connections. Make sure that the E5□C-T and cold junction compensator are connected by a compensating conductor for the thermocouple that is to be used during actual operation.

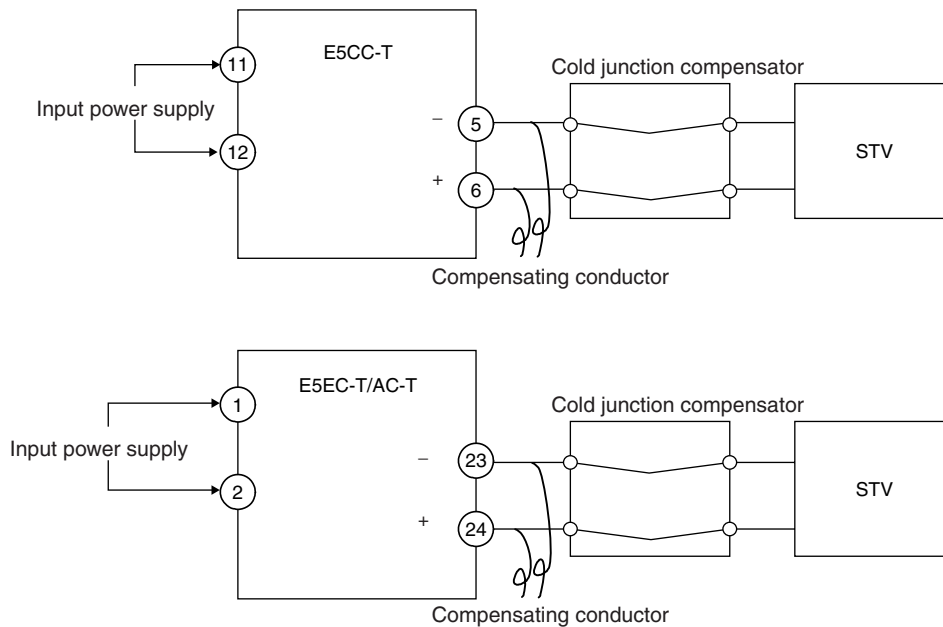

- Operation

Make sure that the cold junction compensator is at 0°C, and set the STV output to the voltage equivalent of the starting power of the check value.

The cold junction compensator and compensation conductor are not required when an external cold junction compensation method is used.

● **Resistance Thermometer**

- Preparations

The diagram below shows the required device connections.

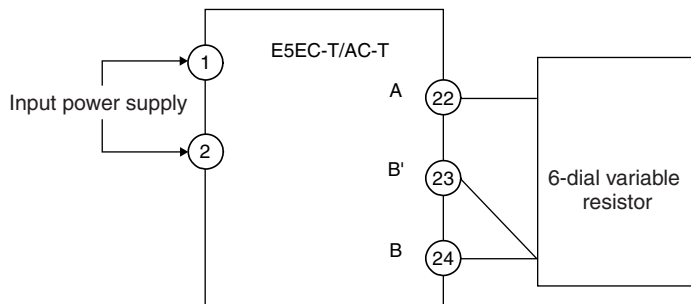
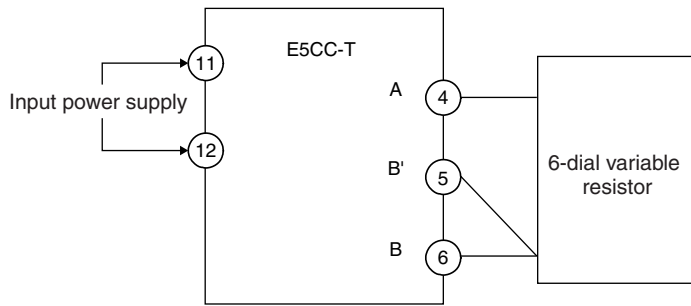

- Operation

Set the 6-dial variable resistor to the resistance that is equivalent to the test value.

## ● Analog Input

### • Preparations

The diagram below shows the required device connections.

(The connection terminals depend on the model and input type.)

### Current Input

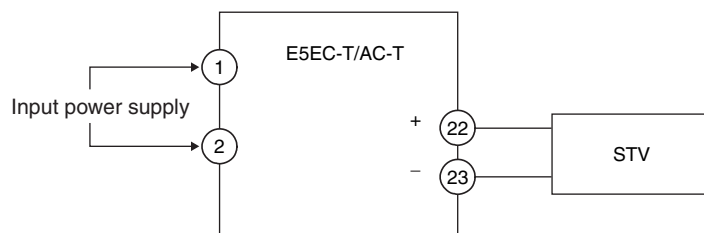
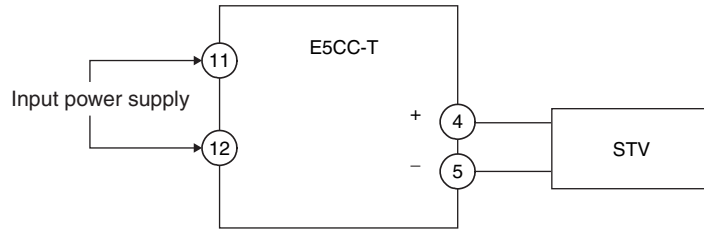

### Voltage Input

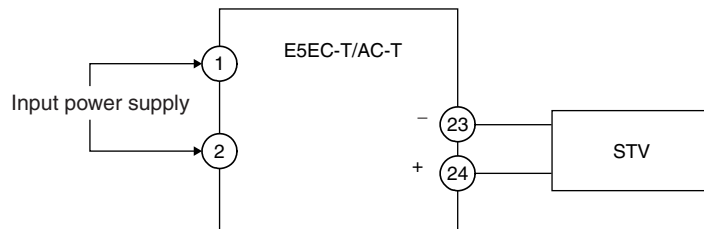
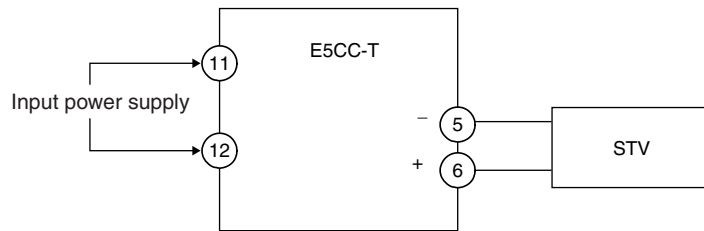

### • Operation

Set the STV output to the voltage or current test value.







# Appendices

---

<b>A-1 Specifications</b> .....	<b>A-2</b>
A-1-1 Ratings .....	A-2
A-1-2 Characteristics .....	A-4
A-1-4 Waterproof Packing .....	A-6
A-1-5 Setup Tool Port Cover for Front Panel .....	A-7
<b>A-2 Current Transformer (CT)</b> .....	<b>A-8</b>
A-2-1 Specifications .....	A-8
A-2-2 Dimensions (Unit: mm) .....	A-8
<b>A-3 USB-Serial Conversion Cable and Conversion Cable</b> .....	<b>A-9</b>
A-3-1 E58-CIFQ2 USB-Serial Conversion Cable .....	A-9
A-3-2 E58-CIFQ2-E Conversion Cable .....	A-10
<b>A-4 Error Displays</b> .....	<b>A-11</b>
<b>A-5 Troubleshooting</b> .....	<b>A-15</b>
<b>A-6 Parameter Operation Lists</b> .....	<b>A-18</b>
A-6-1 Operation Level .....	A-18
A-6-2 Program Setting Level .....	A-19
A-6-3 Adjustment Level .....	A-20
A-6-4 PID Setting Level .....	A-22
A-6-5 Initial Setting Level .....	A-23
A-6-6 Manual Control Level .....	A-26
A-6-7 Monitor/Setting Item Level .....	A-26
A-6-8 Advanced Function Setting Level .....	A-27
A-6-9 Protect Level .....	A-31
A-6-10 Communications Setting Level .....	A-32
A-6-11 Initialization According to Parameter Changes .....	A-33
<b>A-7 Sensor Input Setting Range, Indication Range, Control Range</b> .....	<b>A-36</b>
<b>A-8 Setting Levels Diagram</b> .....	<b>A-37</b>
<b>A-9 Parameter Flow</b> .....	<b>A-38</b>

A

# A-1 Specifications

## A-1-1 Ratings

<b>Supply voltage</b>		A in model number: 100 to 240 VAC, 50/60 Hz D in model number: 24 VAC, 50/60 Hz; 24 VDC
<b>Operating voltage range</b>		85% to 110% of rated supply voltage
<b>Power consumption</b>	<b>E5CC-T</b>	7.5 VA max. at 100 to 240 VAC, and 4.1 VA max. at 24 VDC or 2.3 W max. at 24 VDC
	<b>E5EC-T</b>	8.7 VA max. at 100 to 240 VAC, and 5.5 VA max. at 24 VDC or 3.2 W max. at 24 VDC
	<b>E5AC-T</b>	9.0 VA max. at 100 to 240 VAC, and 5.6 VA max. at 24 VDC or 3.4 W max. at 24 VDC
<b>Sensor input</b>		Temperature Input Thermocouple: K, J, T, E, L, U, N, R, S, B, W, or PLII Platinum resistance thermometer: Pt100 or JPt100 Infrared Temperature Sensor (ES1B): 10 to 70°C, 60 to 120°C, 115 to 165°C, or 140 to 260°C Analog Input Current input: 4 to 20 mA or 0 to 20 mA Voltage input: 1 to 5 V, 0 to 5 V, or 0 to 10 V
<b>Input impedance</b>		Current input: 150 Ω max., Voltage input: 1 MΩ min. (Use a 1:1 connection when connecting the ES2-HB/THB.)
<b>Control method</b>		2-PID control (with auto-tuning) or ON/OFF control
<b>Control outputs</b>	<b>Relay outputs</b>	E5CC-T: SPST-NO, 250 VAC, 3 A (resistive load), Electrical life: 100,000 operations, Minimum applicable load: 10 mA at 5 V (reference value) E5EC-T/E5AC-T: SPST-NO, 250 VAC, 5 A (resistive load), Electrical life: 100,000 operations, Minimum applicable load: 10 mA at 5 V (reference value)
	<b>Voltage outputs (for driving SSR)</b>	E5CC-T: Output voltage: 12 VDC ±20% (PNP), Maximum load current: 21 mA, With short-circuit protection circuit E5EC-T/E5AC-T: Output voltage: 12 VDC ±20% (PNP), Maximum load current: 40 mA, With short-circuit protection circuit (The maximum load current is 21 mA for models with two control outputs.)
	<b>Linear current outputs</b>	4 to 20 mA DC/0 to 20 mA DC, Load: 500 Ω max., Resolution: Approx. 10,000
<b>Auxiliary outputs</b>	<b>Number of outputs</b>	E5CC-T: 3, E5EC-T/E5AC-T: 4
	<b>Output specifications</b>	SPST-NO relay outputs, 250 VAC, 2 A (resistive load), Electrical life: 100,000 operations, Minimum applicable load: 10 mA at 5 V (reference value)
<b>Event inputs</b>	<b>Number of inputs</b>	2, 4, or 6 (depends on model)
	<b>External contact input specifications</b>	Contact input ON: 1 kΩ max., OFF: 100 kΩ min. Non-contact input ON: Residual voltage 1.5 V max., OFF: Leakage current 0.1 mA max.
		Current flow: Approx. 7 mA per contact
<b>Communications</b>	<b>Number of channels</b>	1 (only on models with communications)
	<b>Communications specifications</b>	Transmission path: RS-485 Communications method: RS-485 (2-wire, half duplex) Synchronization: Start-stop Baud rate: 9.6, 19.2, 38.4, or 57.6 kbps

Transfer output	Number of outputs	1 (only on models with a transfer output)
	Output specifications	Current output: 4 to 20 mA DC, Load: 500 Ω max., Resolution: Approx. 10,000 ±0.3% Linear voltage output: 1 to 5 VDC, Load: 1 kΩ min., Resolution: Approx. 10,000 ±0.3%
Potentiometer input		100 Ω to 10 kΩ
Setting method		Digital setting using front panel keys
Indication method		11-segment digital displays and individual indicators Number of digits: 4
	E5CC-T	Character heights: PV: 15.2 mm, SV: 7.1 mm
	E5EC-T/E5AC-T	Character heights: E5EC-T: PV: 18.0 mm, SV: 11.0 mm, MV: 7.8 mm E5AC-T: PV: 25.0 mm, SV: 15.0 mm, MV: 9.5 mm Three display levels. Contents: PV, SP, program No. and segment No., remaining segment time, or MV (valve opening)
Bank switching function		None
Other functions		Manual output, heating/cooling control, loop burnout alarm, other alarm functions, heater burnout (HB) alarm (including SSR failure (HS) alarm), 40% AT, 100% AT, MV limiter, input digital filter, robust tuning, PV input shift, protection functions, extraction of square root, MV change rate limit, logic operations, temperature status display, moving input average, and display brightness setting
Ambient temperature		-10 to 55°C (with no condensation or icing), For 3-year warranty: -10 to 50°C (with no condensation or icing)
Ambient humidity		25% to 85%
Storage temperature		-25 to 65°C (with no condensation or icing)
Altitude		2,000 m max.
Recommended fuse		T2A, 250 VAC, time-lag, low-breaking capacity
Installation environment		Installation Category II, Pollution Degree 2 (IEC 651010-1 compliant)

● HB and HS Alarms

(E5□C-T Models with HB and HS Alarms)

Max. heater current	50 A AC
Input current readout accuracy	±5% FS ±1 digit max.
Heater burnout alarm setting range	0.1 to 49.9 A (0.1 A units) 0.0 A: Heater burnout alarm output turns OFF. 50.0 A: Heater burnout alarm output turns ON. Min. detection ON time *1: 30 ms for a control period of 0.1 s or 0.2 s 100 ms for a control period of 0.5 s or 1 to 99 s
Heater short alarm setting range	0.1 to 49.9 A (0.1 A units) 0.0 A: Heater short alarm output turns ON. 50.0 A: Heater short alarm output turns OFF. Min. detection OFF time *2: 35 ms for a control period of 0.1 s or 0.2 s 100 ms for a control period of 0.5 s or 1 to 99 s

\*1 HB alarms are not detected and the heater power is not measured if the ON time for the control output for heating is 100 ms or less (30 ms or less if the control period is 0.1 or 0.2 s).

\*2 HS alarms are not detected and the leakage power is not measured if the ON time for the control output for heating is 100 ms or less (35 ms or less if the control period is 0.1 or 0.2 s).

## A-1-2 Characteristics

<b>Indication accuracy (at ambient temperature of 23°C)</b>	Thermocouple: ( $\pm 0.3\%$ of indication value or $\pm 1^\circ\text{C}$ , whichever is greater) $\pm 1$ digit max.* <sup>1</sup>	
	Platinum resistance thermometer: ( $\pm 0.2\%$ of indication value or $\pm 0.8^\circ\text{C}$ , whichever is greater) $\pm 1$ digit max.	
	Analog input: $\pm 0.2\%$ FS $\pm 1$ digit max.	
	CT input: $\pm 5\%$ FS $\pm 1$ digit max.	
	Potentiometer: Analog input: $\pm 5\%$ FS $\pm 1$ digit max.	
<b>Transfer output accuracy</b>	$\pm 0.3\%$ FS max.	
<b>Temperature variation influence</b> * <sup>2</sup>	R, S, B, W, or PLII thermocouple input: ( $\pm 1\%$ of indication value or $\pm 10^\circ\text{C}$ , whichever is greater) $\pm 1$ digit max.	
<b>Voltage variation influence</b> * <sup>2</sup>	Other thermocouple input: ( $\pm 1\%$ of indication value or $\pm 4^\circ\text{C}$ , whichever is greater) $\pm 1$ digit max.* <sup>3</sup>	
	Platinum resistance thermometer input: ( $\pm 1\%$ of indication value or $\pm 2^\circ\text{C}$ , whichever is greater) $\pm 1$ digit max.	
	Analog input: $\pm 1\%$ FS $\pm 1$ digit max. CT input: $\pm 5\%$ FS $\pm 1$ digit max.	
<b>Input sampling period</b>	50 ms	
<b>Hysteresis</b>	Temperature input: 0.1 to 999.9°C or °F (in units of 0.1°C or °F) Analog input: 0.01% to 99.99% FS (in units of 0.01% FS)	
<b>Proportional band (P)</b>	Temperature input: 0.1 to 999.9°C or °F (in units of 0.1°C or °F) Analog input: 0.1% to 999.9% FS (in units of 0.1% FS)	
<b>Integral time (I)</b>	Standard, heating/cooling, or close position-proportional control: 0 to 9999 s (in units of 1 s), 0.0 to 999.9 s (in units of 0.1 s)	
	Floating position-proportional control: 1 to 9999 s (in units of 1 s), 0.1 to 999.9 s (in units of 0.1 s)* <sup>4</sup>	
<b>Derivative time (D)</b>	0 to 9,999 s (in units of 1 s), 0.0 to 999.9 s (in units of 0.1 s)* <sup>4</sup>	
<b>Proportional band (cooling) (C-P)</b>	Temperature input: 0.1 to 999.9°C or °F (in units of 0.1°C or °F) Analog input: 0.1% to 999.9% FS (in units of 0.1% FS)	
<b>Integral time (cooling) (C-I)</b>	0 to 9,999 s (in units of 1 s), 0.0 to 999.9 s (in units of 0.1 s)* <sup>4</sup>	
<b>Derivative time (cooling) (C-D)</b>	0 to 9,999 s (in units of 1 s), 0.0 to 999.9 s (in units of 0.1 s)* <sup>4</sup>	
<b>Control Period</b>	0.1, 0.2, 0.5, or 1 to 99 s (in units of 1 s)	
<b>Manual reset value</b>	0.0% to 100.0% (in units of 0.1%)	
<b>Alarm setting range</b>	-1,999 to 9,999 (decimal point position depends on input type)	
<b>Influence of signal source resistance</b>	Thermocouple: 0.1°C/ $\Omega$ max. (100 $\Omega$ max.), Platinum resistance thermometer: 0.1°C/ $\Omega$ max. (10 $\Omega$ max.)	
<b>Insulation resistance</b>	20 M $\Omega$ min. (at 500 VDC)	
<b>Dielectric strength</b>	3,000 VAC, 50/60 Hz for 1 min between terminals of different charge	
<b>Vibration</b>	<b>Malfunction</b>	10 to 55 Hz, 20 m/s <sup>2</sup> for 10 min each in X, Y and Z directions
	<b>Durability</b>	10 to 55 Hz, 20 m/s <sup>2</sup> for 2 hr each in X, Y, and Z directions
<b>Shock</b>	<b>Malfunction</b>	100 m/s <sup>2</sup> , 3 times each in X, Y, and Z directions
	<b>Durability</b>	300 m/s <sup>2</sup> , 3 times each in X, Y, and Z directions
<b>Weight</b>	<b>E5CC-T</b>	Controller: Approx. 120 g, Adapter: Approx. 10 g Terminal Cover: Approx. 0.5 g each
	<b>E5EC-T</b>	Controller: Approx. 210 g, Adapters: Approx. 4 g $\times$ 2 Terminal Cover: Approx. 1 g each
	<b>E5AC-T</b>	Controller: Approx. 250 g, Adapters: Approx. 4 g $\times$ 2 Terminal Cover: Approx. 1 g each
<b>Degree of protection</b>	Front panel: IP66, rear case: IP20, terminals: IP00	
<b>Memory protection</b>	Non-volatile memory (number of writes: 1,000,000)	
<b>Setup Tool</b>	CX-Thermo version 4.61 or higher	

<b>Setup Tool ports</b>	<p>Top panel: An E58-CIFQ2 USB-Serial Conversion Cable is used to connect to a USB port on the computer.*5</p> <p>Front panel (E5EC-T/E5AC-T): An E58-CIFQ2 USB-Serial Conversion Cable and E58-CIFQ2-E Conversion Cable are used together to connect a USB port on the computer.*5</p>
-------------------------	---



- \*1 The indication accuracy of K thermocouples in the -200 to 1,300°C range, T and N thermocouples at a temperature of -100°C or less, and U and L thermocouples at any temperature is  $\pm 2^\circ\text{C} \pm 1$  digit maximum.  
 The indication accuracy of B thermocouples at a temperature of 400°C max. is not specified.  
 The indication accuracy of B thermocouples at a temperature of 400 to 800°C is  $\pm 3^\circ\text{C}$  max.  
 The indication accuracy of R and S thermocouples at a temperature of 200°C max. is  $\pm 3^\circ\text{C} \pm 1$  digit max.  
 The indication accuracy of W thermocouples is ( $\pm 0.3\%$  of PV or  $\pm 3^\circ\text{C}$ , whichever is greater)  $\pm 1$  digit max.  
 The indication accuracy of PLII thermocouples is ( $\pm 0.3\%$  of PV or  $\pm 2^\circ\text{C}$ , whichever is greater)  $\pm 1$  digit max.
- \*2 Ambient temperature: -10°C to 23°C to 55°C  
 Voltage range: -15% to +10% of rated voltage
- \*3 K thermocouple at -100°C max.:  $\pm 10^\circ\text{C}$  max.
- \*4 The unit is determined by the setting of the Integral/Derivative Time Unit parameter.
- \*5 External serial communications (RS-485) and USB-Serial Conversion Cable communications can be used at the same time.

### A-1-3 Program Controls

<b>Number of programs (patterns)</b>		8
<b>Number of segments (steps)</b>		32
<b>Segment setting method</b>		Step time programming (SP and time are set for each segment.)
		Rate of rise programming (Segment format, SP, slope, and/or time are set for each segment.)
<b>Segment time</b>		0 hr 0 min to 99 hr 59 min
		0 min 0 s to 99 min 59 s
<b>Alarm settings</b>		Alarms are set for each program.
<b>Reset operation</b>		You can select either to stop control or use fixed SP control.
<b>Startup operation</b>		You can select one of the following: Continue, reset, run, or Manual Mode.
<b>PID sets</b>	<b>Number of sets</b>	8 sets
	<b>Setting method</b>	A PID set is specified for each program. (Automatic PID set selection is also possible.)
<b>Alarm SP selection</b>		You can select from the ramp SP or target SP.
<b>Program status control</b>	<b>Segment operation</b>	Advance, segment jump, hold, and wait
	<b>Program operation</b>	Repeating and linking programs
<b>Waiting</b>	<b>Wait method</b>	At the end of segments
	<b>Wait band setting</b>	The same wait band is used for the entire program.
<b>Time signals</b>	<b>Number of outputs</b>	2
	<b>Number of ON/OFF operations</b>	One time per output
	<b>Setting method</b>	Time signals are set for each program.
<b>Program status output</b>		Program end output (settable pulse width), RUN output, and stage output
<b>Program startup operation</b>	<b>PV start</b>	You can select an SP start or an PV start with slope priority.
	<b>Standby</b>	0 hr 0 min to 99 hr 59 min 0 days, 0 hr to 99 days 23 hr
<b>Operation end operation</b>		You can select from the following: reset, continue, and Fixed SP Mode.
<b>Program SP shift</b>		The same program SP shift is used for the entire program.

### A-1-4 Waterproof Packing

If the Waterproof Packing is lost or damage, order one of the following models.

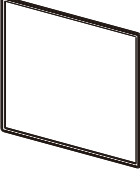
Y92S-P8 (for DIN 48 × 48)	Y92S-P9 (for DIN 48 × 96)
	
Y92S-P10 (for DIN 96 × 96)	
	

## A-1-5 Setup Tool Port Cover for Front Panel

A Y92F-P7 Setup Tool Port Cover for the front panel is included with the E5EC-T/E5AC-T. Order this Port Cover separately if the Port Cover on the front-panel Setup Tool port is lost or damaged. The Waterproof Packing must be periodically replaced because it may deteriorate, shrink, or harden depending on the operating environment.

Y92S-P7



Use the following procedure to replace the Setup Tool Port Cover for the front panel.

### ● Replacement Procedure

<p><b>1</b> Open the Setup Tool Port Cover on the front panel.</p>	
<p><b>2</b> Pull gently on the Setup Tool Port Cover to remove it from the Digital Controller.</p>	
<p><b>3</b> Insert the stopper on the Setup Tool Port Cover into the hole at the bottom of the port.</p>	
<p><b>4</b> Make sure that the Setup Tool Port Cover is closed.</p>	

# A-2 Current Transformer (CT)

## A-2-1 Specifications

Item	Specifications	
Model number	E54-CT1	E54-CT3
Max. continuous current	50 A	120 A <sup>*1</sup>
Dielectric strength	1,000 VAC (for 1 min)	
Vibration resistance	50 Hz, 98 m/s <sup>2</sup>	
Weight	Approx. 11.5 g	Approx. 50 g
Accessories	None	Armature (2), Plug (2)

\*1 The maximum continuous current of the E5□C-T is 50 A.

## A-2-2 Dimensions (Unit: mm)

- E54-CT1

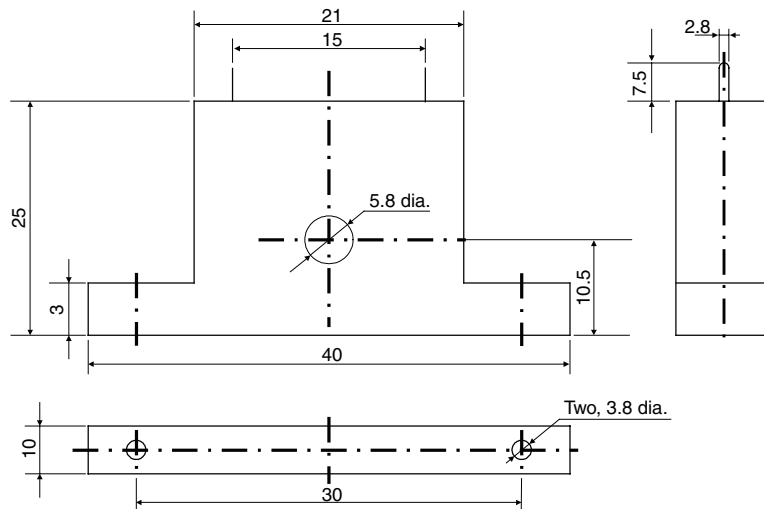

- E54-CT3

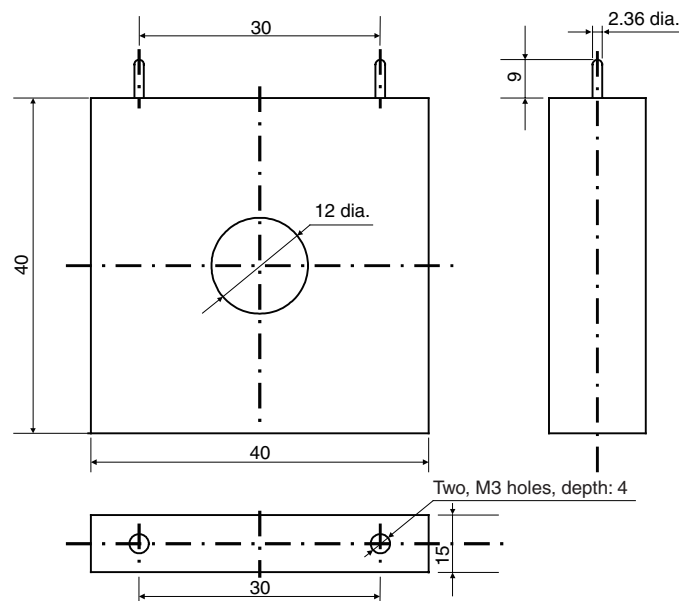



## A-3 USB-Serial Conversion Cable and Conversion Cable

A USB-Serial Conversion Cable is used to connect the E5□C-T to a computer. The E58-CIFQ2-E Conversion Cable is also required to connect to the Setup Tool port on the front panel of the E5EC-T or E5AC-T. The following table lists the cables and ports that are used.

Connection port	Cable
Setup Tool port on top panel	E58-CIFQ2 USB-Serial Conversion Cable
Front-panel Setup Tool port (E5EC-T/E5AC-T only)	E58-CIFQ2 USB-Serial Conversion Cable and E58-CIFQ2-E Conversion Cable

Refer to 2-4 *Using the Setup Tool Port* for the connection procedure.

### A-3-1 E58-CIFQ2 USB-Serial Conversion Cable

#### ● Specifications

Item	Specifications
Applicable OS	Windows XP, Vista, or 7
Applicable software	E5CC-T, E5EC-T, or E5AC-T: CX-Thermo version 4.61 or higher
Applicable models	E5CB Series, E5□C Series, and E5□C-T Series
USB interface rating	Conforms to USB Specification 2.0
DTE speed	38,400 bps
Connector specifications	Computer end: USB (type A plug) Digital Controller: Special serial connector
Power supply	Bus power (Supplied from USB host controller)
Power supply voltage	5 VDC
Current consumption	450 mA max.
Output voltage	4.7±0.2 VDC (Supplied through USB-Serial Conversion Cable to the Digital Controller.)
Output current	250 mA max. (Supplied through USB-Serial Conversion Cable to the Digital Controller.)
Ambient temperature	0 to 55°C (with no condensation or icing)
Ambient humidity	10% to 80%
Storage temperature	-20 to 60°C (with no condensation or icing)
Storage humidity	10% to 80%
Altitude	2,000 m max.
Weight	Approx. 120 g

Windows is a registered trademark of Microsoft Corporation in the United States and other countries.

Note: Use a high-power port for the USB port.

● Dimensions

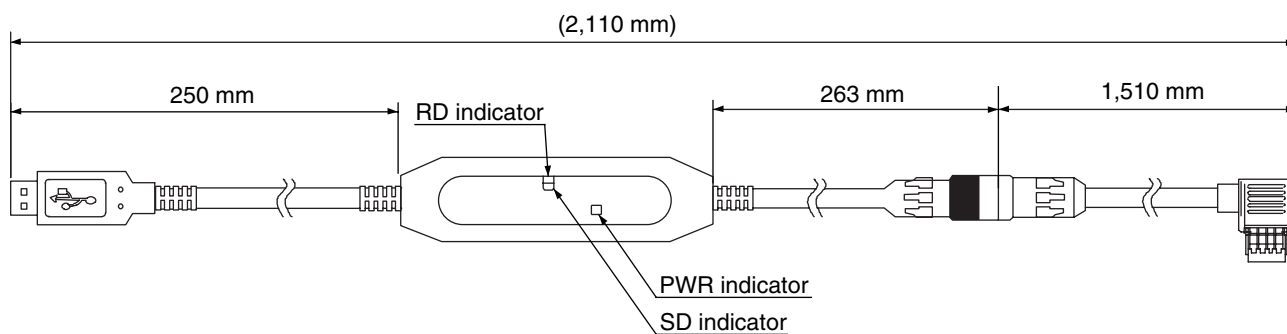

LED Indicator Display

Indicator	Color	Status	Meaning
PWR	Green	Lit.	USB bus power is being supplied.
		Not lit.	USB bus power is not being supplied.
SD	Yellow	Lit	Sending data from USB-Serial Conversion Cable
		Not lit	Not sending data from USB-Serial Conversion Cable
RD	Yellow	Lit	Receiving data from the USB-Serial Conversion Cable
		Not lit	Not receiving data from the USB-Serial Conversion Cable

**A-3-2 E58-CIFQ2-E Conversion Cable**

● Specifications

Item	Specification
Applicable models	E5EC/E5AC Series and E5EC-T/E5AC-T Series
Connector specifications	Digital Controller: 4-pin plug E58-CIFQ2: Small special connector
Ambient temperature	0 to 55°C (with no condensation or icing)
Ambient humidity	10% to 80%
Storage temperature	-20 to 60°C (with no condensation or icing)
Storage humidity	10% to 80%
Altitude	2,000 m max.
Weight	Approx. 60 g

● Dimensions

**E58-CIFQ2-E Conversion Cable**

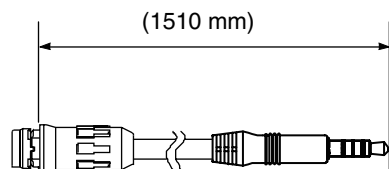

**Connected to the E58-CIFQ2 USB-Serial Conversion Cable**

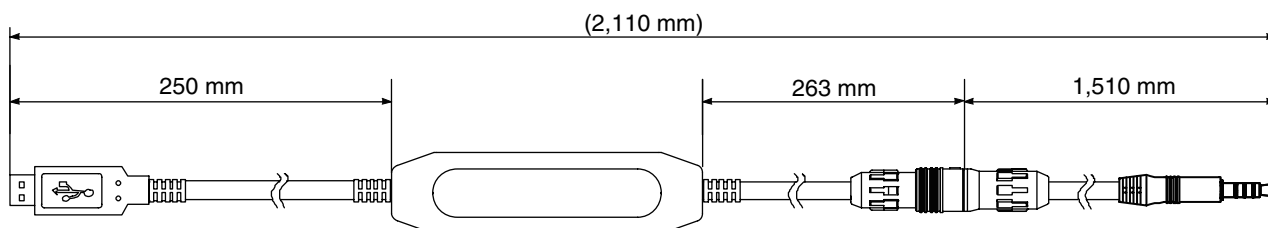

## A-4 Error Displays

When an error occurs, the error contents are shown on the No. 1 or the No. 2 display. This section describes how to check error codes on the display, and the actions to be taken to remedy the problems.

---

*S.ERR*    Input Error

---

### ● Meaning

The input value has exceeded the control range. \*

The input type setting is not correct.

The sensor is disconnected or shorted.

The sensor wiring is not correct.

The sensor is not wired.

\* Control Range

Resistance thermometer, thermocouple input:	Temperature setting lower limit $-20^{\circ}\text{C}$ to temperature setting upper limit $+20^{\circ}\text{C}$ (Temperature setting lower limit $-40^{\circ}\text{F}$ to temperature setting upper limit $+40^{\circ}\text{F}$ )
ES1B input:	Same as input indication range
Analog input:	$-5\%$ to $+105\%$ of scaling range

### ● Action

Check the wiring of inputs for miswiring, disconnections, and short-circuits and check the input type.

If no abnormality is found in the wiring and input type, turn the power OFF then back ON again.

If the display remains the same, the Controller must be replaced. If the display is restored, then the probable cause is electrical noise affecting the control system. Check for electrical noise.

Note: With resistance thermometer input, a break in the A, B, or B' line is regarded as a disconnection.

### ● Operation

After an error occurs, the error is displayed and the alarm outputs function as if the upper limit has been exceeded.

It will also operate as if transfer output exceeded the upper limit. If an input error is assigned to a control output or auxiliary output, the output will turn ON when the input error occurs. The error message will appear in the display for the PV.

Note: The heating and cooling control outputs will turn OFF. When the manual MV, MV at reset, or MV at PV error is set, the control output is determined by the set value.

cccc  
 9999  
**Display Range Exceeded**

● **Meaning**

Though this is not an error, it is displayed if the process value exceeds the display range when the control range is larger than the display range.

The display ranges are shown below (with decimal points omitted).

- When less than -1,999: ccccc
- When more than 9,999: 9999

● **Operation**

Control continues, allowing normal operation. The value will appear in the display for the PV.

Resistance thermometer input (Except for models with a setting range of -199.9 to 500.0°C)  
 Thermocouple input (Except for models with a setting range of -199.9 to 400.0°C)

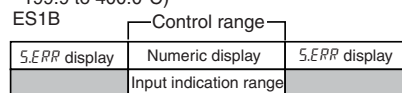

Resistance thermometer input (Except for models with a setting range of -1999. to 500.0°C)  
 Thermocouple input (Except for models with a setting range of -199.9 to 400.0°C)

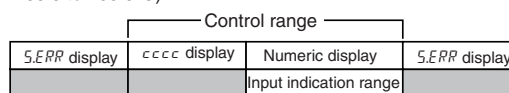

Analog Input  
 • When display range < control range

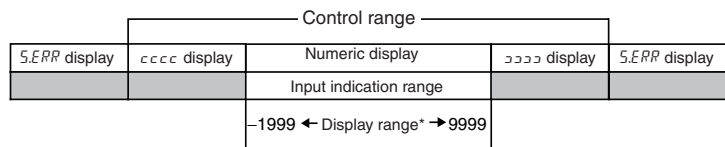

Analog Input  
 • When display range ≥ control range

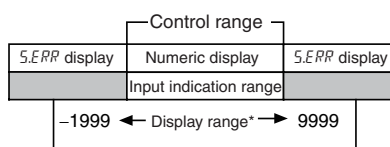

\*The display range is shown in numbers with decimal points omitted.

E333 **AD Converter Error**

● **Meaning**

There is an error in internal circuits.

● **Action**

First, turn the power OFF then back ON again. If the display remains the same, the Controller must be repaired. If the display is restored, then the probable cause is electrical noise affecting the control system. Check for electrical noise.

● **Operation**

The control, auxiliary, and transfer outputs turn OFF. (A linear current output will be approx. 0 mA. A linear voltage output will be approx. 0 V.)

---

**E111**    **Memory Error**

---

- **Meaning**

Internal memory operation is in error.

- **Action**

First, turn the power OFF then back ON again. If the display remains the same, the Controller must be repaired. If the display is restored, then the probable cause is electrical noise affecting the control system. Check for electrical noise.

- **Operation**

The control, auxiliary, and transfer outputs turn OFF. (A linear current output will be approx. 0 mA. A linear voltage output will be approx. 0 V.)

---

**FFFF**    **Current Value Exceeds**

---

- **Meaning**

This error is displayed when the heater current value exceeds 55.0 A.

- **Operation**

Control continues, allowing normal operation. An error message is displayed when the following items are displayed.

Heater current 1 value monitor

Heater current 2 value monitor

Leakage current 1 monitor

Leakage current 2 monitor

---

```

  LL1
  LL2      HB Alarm
  LCR1     HS Alarm
  LCR2

```

---

- **Meaning**

If there is an HB or HS alarm, the relevant parameter will flash on the No. 1 display.

- **Operation**

The relevant Heater Current 1 Value Monitor, Heater Current 2 Value Monitor, Leakage Current 1 Monitor, or Leakage Current 2 Monitor parameters in the Operation or Adjustment Level will flash on the No. 1 display. However, control continues and operation is normal.

---

---- Potentiometer Input Error (Position-proportional Models Only)

---

● **Meaning**

“----” will be displayed for the Valve Opening Monitor parameter if any of the following error occurs.

- Motor calibration has not been performed.
- The wiring of the potentiometer is incorrect or broken.
- The potentiometer input value is incorrect (e.g., the input is out of range or the potentiometer has failed).

● **Action**

Check for the above errors.

● **Operation**

Close control: The control output is OFF or the value that is set for the MV at PV Error parameter is output.

Floating control: Operation will be normal.

# A-5 Troubleshooting

## Checking Problems

If the Digital Controller is not operating normally, check the following points before requesting repairs. If the problem persists, contact your OMRON representative for details on returning the product.

Timing	Status	Meaning	Countermeasures	Page
Turning ON the power for the first time	Temperature error is large. Input error (S.Err display)	Input type mismatch	Check the sensor type and reset the input type correctly.	4-19
		Thermometer is not installed properly.	Check the thermometer installation location and polarity and install correctly.	2-8, 2-12
	Communications are not possible.	Non-recommended adapter is being used.	Make sure that the connected device is not faulty.	*
During operation	Overshooting Undershooting Hunting	ON/OFF control is enabled (default: PID control selected).	Select PID control and perform autotuning.	4-49
		Control period is longer compared with the speed of rise and fall in temperature.	Shorten the control period. A shorter control period improves control performance, but a cycle of 20 ms minimum is recommended in consideration of the service life of the relays.	4-22
		Unsuitable PID constant	Set appropriate PID constants using either of the following methods. <ul style="list-style-type: none"> <li>Execute AT (autotuning).</li> <li>Set PID constants individually using manual settings.</li> </ul>	4-49
		HS alarm operation fault	Use breeder resistance if the problem is due to leakage current. Also investigate the errors detected by the HS alarm function.	4-66
	Temperature is not rising	Specified operation is unsuitable for required control (default: Reverse operation).	Select either forward or reverse operation depending on the required control. Reverse operation is used for heating operations.	4-22
		Heater is burnt out or deteriorated.	Check whether heater burnout or deterioration have occurred. Also investigate the errors detected by the heater burnout alarm.	4-64
		Insufficient heater capacity	Check whether the heater's heating capacity is sufficient.	---
		Cooling system in operation.	Check whether a cooling system is operating.	---
		Peripheral devices have heat prevention device operating.	Set the heating prevention temperature setting to a value higher than the set temperature of the Digital Controller.	---

\* Also refer to the *E5□C-T Digital Temperature Controllers Communications Manual* (Cat. No. H186) for details.

Timing	Status	Meaning	Countermeasures	Page
During operation (continued)	Output will not turn ON	The Digital Controller is set to reset status. (default: RST)	Set the Run/Reset parameter to Run. If the reset operation is set to stop control, control will stop when the RST indicator lights.	5-12
		Specified operation is unsuitable for required control (default: Reverse operation).	Select either forward or reverse operation depending on the required control. Reverse operation is used for heating operations.	4-22
		A high hysteresis is set for ON/OFF operation (default: 1.0°C)	Set a suitable value for the hysteresis.	4-74
		The specified power is not being supplied from the terminals.	The output will not turn ON while the Digital Controller is being operated with power supplied through the USB-Serial Conversion Cable. Supply the specified power from the terminals.	---
	Temperature Controller will not operate	The Digital Controller is set to reset status. (default: RST)	Set the Run/Reset parameter to Run. If the reset operation is set to stop control, control will stop when the RST indicator lights.	5-12
	Temperature error is large Input error (S.err display)	Thermometer has burnt out or short-circuited.	Check whether the thermometer has burnt out or short-circuited.	---
		Thermometer lead wires and power lines are in the same conduit, causing noise from the power lines (generally, display values will be unstable).	Wire the lead wires and power lines in separate conduits, or wire them using a more direct path.	---
		Connection between the Digital Controller and thermocouple is using copper wires.	Connect the thermocouple's lead wires directly, or connect compensating conductors that are suitable for the thermocouple.	---
		Installation location of thermometer is unsuitable.	Make sure that the location that is being measured with the temperature sensor is suitable.	---
		Input shift is not set correctly (default: 0°C)	Set a suitable input shift. If input shift is not required, set the input shift value to 0.0.	5-3
	Keys will not operate	Setting change protect is ON.	Turn OFF setting change protect.	5-18
	Cannot shift levels	Operations limited due to protection.	Set the operation/adjustment protect, initial setting/communications protect, and setting change protect values as required.	5-19
	SP does not change as programmed.	The Temperature Controller is in Fixed SP Mode.	Set Program SP Mode.	
	The segment does not advance.	The wait operation is functioning.	Set the wait band correctly.	
The SP is being held.		Check the HOLD indicator. If it is lit, change the Hold parameter to OFF.		
After long service life	Control is unstable	Terminal screws may be loose.	Retighten terminal screws to a torque of 0.43 to 0.58 N·m.	2-16
		The internal components have reached the end of their service life.	The Digital Controller's internal electrolytic capacitor depends on the ambient temperature, and load rate. The structural life depends on the ambient environment (shock, vibration). The life expectancy of the output relays varies greatly with the switching capacity and other switching conditions. Always use the output relays within their rated load and electrical life expectancy. If an output relay is used beyond its life expectancy, its contacts may become welded or burned. Replace the Digital Controller and all other Digital Controllers purchased in the same time period.	---



**Symptom: Cannot Communicate or a Communications Error Occurs**

Meaning	Countermeasures
The communications wiring is not correct.	Correct the wiring.
The communications line has become disconnected.	Connect the communications line securely and tighten the screws.
The communications cable is broken.	Replace the cable.
The communications cable is too long.	The total cable length for RS-485 is 500 m max.
The wrong communications cable has been used.	Use a shielded, AWG24 to AWG18 (cross-sectional area of 0.205 to 0.823 mm <sup>2</sup> ) twisted-pair cable for the communications cable.
More than the specified number of communications devices are connected to the same communications path.	When 1:N communications are used, a maximum of 32 nodes may be connected, including the host node.
An end node has not been set at each end of the communications line.	Set or connect terminating resistance at each end of the line. If the E5□C-T is the end node, 120-Ω (1/2-W) terminating resistance is used. Be sure that the combined resistance with the host device is 54 Ω minimum.
The specified power supply voltage is not being supplied to the Controller.	Supply the specified power supply voltage.
The specified power supply voltage is not being supplied to an Interface Converter (such as the K3SC).	Supply the specified power supply voltage.
The same baud rate and communications method are not being used by all of the Controllers, host devices, and other devices on the same communications line.	Set the same values for the baud rate, protocol, data length, stop bits, and parity on all nodes.
The unit number specified in the command frame is different from the unit number set by the Controller.	Use the same unit number.
The same unit number as the Controller is being used for another node on the same communications line.	Set each unit number for only one node.
There is a mistake in programming the host device.	Use a line monitor to check the commands. Check operation using a sample program.
The host device is detecting the absence of a response as an error before it receives the response from the Controller.	Shorten the send data wait time in the Controller or increase the response wait time in the host device.
The host device is detecting the absence of a response as an error after broadcasting a command.	The Controller does not return responses for broadcast commands.
The host device sent another command before receiving a response from the Controller.	The response must always be read after sending a command (except for broadcast commands).
The host device sent the next command too soon after receiving a response from the Controller.	After receiving a response, wait at least 2 ms before sending the next command.
The communications line became unstable when Controller power was turned ON or interrupted, and the host device read the unstable status as data.	Initialize the reception buffer in the host device before sending the first command and after turning OFF the power to the Controller.
The communications data was corrupted from noise from the environment.	Try using a slower baud rate. Separate the communications cable from the source of noise. Use a shielded, twisted-pair cable for the communications cable. Use as short a communications cable as possible, and do not lay or loop extra cable. To prevent inductive noise, do not run the communications cable parallel to a power line. If noise countermeasures are difficult to implement, use an Optical Interface.

\* Also refer to the *E5□C-T Digital Temperature Controllers Communications Manual* (Cat. No. H186) for details on errors.

## A-6 Parameter Operation Lists

### A-6-1 Operation Level

Parameter	Characters	Setting (monitor) value	Display	Default	Unit
Process Value (1) (2)		Temperature: According to indication range for each sensor. Analog: Scaling lower limit -5% FS to Scaling upper limit +5% FS			EU
Set Point (1) (2)		SP lower limit to SP upper limit		0	EU
Auto/Manual Switch	<i>R-M</i>		Auto/Manual	Automatic	None
Program No. Monitor/ Segment No. Monitor	<i>PGSG</i>	During Program Operation Program number: 0 to 7 Segment number: 0 to 31		0.00	None
Program Number	<i>PRG</i>	0 to 7		0	None
Hold	<i>HOLD</i>	ON or OFF	<i>ON, OFF</i>	OFF	None
Segment Number	<i>SEG</i>	0 to 31			None
Remaining Standby Time Monitor	<i>StbM</i>	Standby time in hours and minutes: 0.00 to 99.59 Standby time in days and hours: 0.00 to 99.23			Hours and minutes, or days and hours
Elapsed Program Time Monitor	<i>PRGT</i>	0.00 to 99.59			Hours and minutes, or minutes and seconds
Program Execution Repetitions Monitor	<i>RPLM</i>	0 to 9,999			Repetitions
Heater Current 1 Value Monitor	<i>Et1</i>	0.0 to 55.0			A
Heater Current 2 Value Monitor	<i>Et2</i>	0.0 to 55.0			A
Leakage Current 1 Monitor	<i>LER1</i>	0.0 to 55.0			A
Leakage Current 2 Monitor	<i>LER2</i>	0.0 to 55.0			A
Run/Reset (program)	<i>R-R</i>	Run or Reset	<i>RUN, RSt</i>	RST	None
MV Monitor (Heating)	<i>Δ</i>	-5.0 to 105.5 (standard) 0.0 to 105.0 (heating/cooling)		0.0	%
MV Monitor (Cooling)	<i>[-Δ]</i>	0.0 to 105.0		0.0	%
Valve Opening Monitor	<i>V-M</i>	-10.0 to 110.0		0.0	%

**A-6-2 Program Setting Level**

Parameter	Characters	Setting (monitor) value	Display	Default	Unit
Display Program Selection	<i>d.PRG</i>	0 to 7		Number of program currently used for control.	None
Number of Segments Used	<i>S-Nā</i>	1 to 32		8	None
Display Segment Selection	<i>d.SEG</i>	END or 0 to Number of segments used – 1		END	None
Segment n Format	<i>SEYP</i>	n = 0 to 31 Ramp, Soak, or Step	<i>RAMP, SOAK, STEP</i>	Ramp	None
Segment n SP	<i>SP</i>	n = 0 to 31 SP lower limit to SP upper limit		0	EU
Segment n Slope	<i>PR</i>	n = 0 to 31 0 to 9,999		0	EU/Time Unit of Ramp Rate
Segment n Time	<i>TIME</i>	n = 0 to 31 0.00 to 99.59		0.00	Program Time Unit
PID Set No.	<i>PID</i>	0 to 8 (0: Auto selection)		1	None
Alarm Value 1	<i>RL-1</i>	Alarms Other Than an MV Alarm –1999 to 9999		0	EU
		MV Alarms –199.9 to 999.9		0.0	%
Alarm Upper Limit 1	<i>RL1H</i>	–1999 to 9999		0	EU
Alarm Lower Limit 1	<i>RL1L</i>	–1999 to 9999		0	EU
Alarm Value 2	<i>RL-2</i>	Alarms Other Than an MV Alarm –1999 to 9999		0	EU
		MV Alarms –199.9 to 999.9		0.0	%
Alarm Upper Limit 2	<i>RL2H</i>	–1999 to 9999		0	EU
Alarm Lower Limit 2	<i>RL2L</i>	–1999 to 9999		0	EU
Alarm Value 3	<i>RL-3</i>	Alarms Other Than an MV Alarm –1999 to 9999		0	EU
		MV Alarms –199.9 to 999.9		0.0	%
Alarm Upper Limit 3	<i>RL3H</i>	–1999 to 9999		0	EU
Alarm Lower Limit 3	<i>RL3L</i>	–1999 to 9999		0	EU
Alarm Value 4	<i>RL-4</i>	Alarms Other Than an MV Alarm –1999 to 9999		0	EU
		MV Alarms –199.9 to 999.9		0.0	%
Alarm Upper Limit 4	<i>RL4H</i>	–1999 to 9999		0	EU
Alarm Lower Limit 4	<i>RL4L</i>	–1999 to 9999		0	EU
Program Repetitions	<i>RPE</i>	0 to 9999		0	Repetitions
Program Link Destination	<i>LNK</i>	END or 0 to 7		END	None
Time Signal 1 Set Segment	<i>TS1S</i>	0 to 31		0	None
Time Signal 1 ON Time	<i>āN1</i>	0.00 to 99.59		0.00	Program Time Unit
Time Signal 1 OFF Time	<i>āF1</i>	0.00 to 99.59		0.00	Program Time Unit
Time Signal 2 Set Segment	<i>TS2S</i>	0 to 31		0	None
Time Signal 2 ON Time	<i>āN2</i>	0.00 to 99.59		0.00	Program Time Unit
Time Signal 2 OFF Time	<i>āF2</i>	0.00 to 99.59		0.00	Program Time Unit

### A-6-3 Adjustment Level

Parameters	Characters	Setting (monitor) value	Display	Default	Unit
Adjustment Level Display	<i>LAdj</i>				
AT Execute/Cancel	<i>At</i>	OFF, AT Cancel AT-2: 100%AT Execute AT-1: 40%AT Execute* <sup>1</sup> ATA1: All PID 40% AT Execute* <sup>1</sup> ATA2: All PID 100% AT Execute	<i>OFF, At-2, At-1, AtA1, AtA2</i>	OFF	None
Communications Writing	<i>CMWt</i>	OFF, ON	<i>OFF, ON</i>	OFF	None
SP Mode	<i>SPMd</i>	PSP: Program SP FSP: Fixed SP	<i>PSP, FSP</i>	PSP	None
Fixed SP	<i>FSP</i>	SP lower limit to SP upper limit		0	EU
Heater Current 1 Value Monitor	<i>Et1</i>	0.0 to 55.0			A
Heater Burnout Detection 1	<i>Hb1</i>	0.0 to 50.0		0.0	A
Heater Current 2 Value Monitor	<i>Et2</i>	0.0 to 55.0			A
Heater Burnout Detection 2	<i>Hb2</i>	0.0 to 50.0		0.0	A
Leakage Current 1 Value Monitor	<i>LEr1</i>	0.0 to 55.0			A
HS Alarm 1	<i>HS1</i>	0.0 to 50.0		50.0	A
Leakage Current 2 Value Monitor	<i>LEr2</i>	0.0 to 55.0			A
HS Alarm 2	<i>HS2</i>	0.0 to 50.0		50.0	A
PV Input Shift	<i>INS</i>	Temperature input: -199.9 to 999.9		0.0	°C or °F
		Analog input: -1,999 to 9,999		0	EU
PV Slope Coefficient	<i>INRt</i>	0.001 to 9.999		1.000	None
Wait Band	<i>Wt-b</i>	Temperature input: OFF, or 0.1 to 999.9	<i>OFF or 0.1 to 999.9</i>	OFF	°C or °F
		Analog input: OFF, or 0.01 to 99.99	<i>OFF or 0.01 to 99.99</i>	OFF	%FS
Standby Time	<i>Stb</i>	0.00 to 99.59 (hours.minutes)		0.00	Standby Time Unit
		0.00 to 99.23 (days.hours)			
Program SP Shift Value	<i>PSPS</i>	-1,999 to 9,999		0	EU
Proportional Band	<i>P</i>	Temperature input: 0.1 to 999.9		8.0	°C or °F
		Analog input: 0.1 to 999.9		10.0	%FS
Integral Time	<i>I</i>	Standard, heating/cooling, or close position-proportional control:	Integral/Derivative Time Unit of 1 s: 0 to 9,999	233	Seconds
			Integral/Derivative Time Unit of 0.1 s: 0.0 to 999.9	233.0	Seconds
		Floating position-proportional control:	Integral/Derivative Time Unit of 1 s: 1 to 9,999	233	Seconds
			Integral/Derivative Time Unit of 0.1 s: 0.1 to 999.9	233.0	Seconds
Derivative Time	<i>d</i>	Integral/Derivative Time Unit of 1 s: 0 to 9,999		40	Seconds
		Integral/Derivative Time Unit of 0.1 s: 0.0 to 999.9		40.0	
Proportional Band (Cooling)	<i>I-P</i>	Temperature input: 0.1 to 999.9		8.0	°C or °F
		Analog input: 0.1 to 999.9		10.0	%FS
Integral Time (Cooling)	<i>I-I</i>	Integral/Derivative Time Unit of 1 s: 0 to 9,999		233	Seconds
		Integral/Derivative Time Unit of 0.1 s: 0.0 to 999.9		233.0	
Derivative Time (Cooling)	<i>I-d</i>	Integral/Derivative Time Unit of 1 s: 0 to 9,999		40	Seconds
		Integral/Derivative Time Unit of 0.1 s: 0.0 to 999.9		40.0	
Dead Band	<i>I-db</i>	Temperature input: -199.9 to 999.9		0.0	°C or °F
		Analog input: -19.99 to 99.99		0.00	%FS
Manual Reset Value	<i>MR-R</i>	0.0 to 100.0		50.0	%

Parameters	Characters	Setting (monitor) value	Display	Default	Unit
Hysteresis (Heating)	HY5	Temperature input: 0.1 to 999.9		1.0	°C or °F
		Analog input: 0.01 to 99.99		0.10	%FS
Hysteresis (Cooling)	LHY5	Temperature input: 0.1 to 999.9		1.0	°C or °F
		Analog input: 0.01 to 99.99		0.10	%FS
MV at Reset	MV-R	Standard: -5.0 to 105.0 Heating/cooling: -105.0 to 105.0		0.0	%
		Floating position-proportional control or the Direct Setting of Position-proportional MV parameter set to OFF: CLOS, HOLD, or OPEN	LCLdS, HdLd, dPEN	HOLD	None
		Close position-proportional control with the Direct Setting of Position-proportional MV parameter set to ON: -5.0 to 105.0		0.0	%
MV at PV Error	MV-E	Same as for MV at Reset.			
MV Upper Limit	dL-H	Standard control: MV lower limit + 0.1 to 105.0 Heating/cooling control: 0.0 to 105.0		100.0	%
		Close position-proportional control: MV lower limit + 0.1 to 105.0			
MV Lower Limit	dL-L	Standard control: -5.0 to MV upper limit - 0.1		0.0	%
		Heating/cooling control: -105.0 to 0.0		-100.0	
		Close position-proportional control: -5.0 to MV upper limit -0.1		0.0	
MV Change Rate Limit	dRL	0.0 to 100.0 (0.0: MV Change Rate Limit Disabled)		0.0	%/s
Position Proportional Dead Band	db	Close position-proportional control: 0.1 to 10.0		4.0	%
		Floating position-proportional control: 0.1 to 10.0		2.0	
Open/Close Hysteresis	dC-H	0.1 to 20.0		0.8	%
Extraction of Square Root Low-cut Point	SORP	0.0 to 100.0		0.0	%
Work Bit * ON Delay	W1 to BdN	0 to 9999		0	Seconds
Work Bit * OFF Delay	W1 to BdF	0 to 9999		0	Seconds
Communications Monitor	PLEM	0 to 9999			ms

\*1 This setting is not displayed for heating and cooling control or for floating position-proportional control.

### A-6-4 PID Setting Level

Parameters	Characters	Setting (monitor) value		Display	Default	Unit
Display PID Selection	<i>d.P<sup>-</sup>d</i>	1 to 8			Currently selected PID set number	
PID * Proportional Band	<i>*P</i>	Temperature input: 0.1 to 999.9			8.0	°C or °F
		Analog input: 0.1 to 999.9			10.0	%FS
PID * Integral Time	<i>*I</i>	Standard, heating/cooling, or close position-proportional control:	Integral/derivative time unit of 1 s: 0 to 9,999		233	Seconds
			Integral/derivative time unit of 0.1 s: 0.0 to 9,999		233.0	Seconds
		Floating position-proportional control:	Integral/derivative time unit of 1 s: 1 to 9,999		233	Seconds
			Integral/derivative time unit of 0.1 s: 0.1 to 9,999		233.0	Seconds
PID * Derivative Time	<i>*d</i>	Integral/derivative time unit of 1 s: 0 to 9,999			40	Seconds
		Integral/derivative time unit of 0.1 s: 0.0 to 9,999			40.0	
PID * Proportional Band (Cooling)	<i>*I<sup>-</sup>P</i>	Temperature input: 0.1 to 999.9			8.0	°C or °F
		Analog input: 0.1 to 999.9			10.0	%FS
PID * Integral Time (Cooling)	<i>*I<sup>-</sup>I</i>	Integral/derivative time unit of 1 s: 0 to 9,999			233	Seconds
		Integral/derivative time unit of 0.1 s: 0.0 to 999.9			233.0	
PID * Derivative Time (Cooling)	<i>*I<sup>-</sup>d</i>	Integral/derivative time unit of 1 s: 0 to 9,999			40	Seconds
		Integral/derivative time unit of 0.1 s: 0.0 to 999.9			40.0	
PID * Dead Band	<i>*I<sup>-</sup>db</i>	Temperature input: -199.9 to 999.9			0.0	°C or °F
		Analog input: -19.99 to 99.99			0.00	%FS
PID * Manual Reset Value	<i>*oFR</i>	0.0 to 100.0			50.0	%
PID * MV Upper Limit	<i>*oLH</i>	Standard: MV lower limit + 0.1 to 105.0			100.0	%
		Heating/cooling: 0.0 to 105.0				
PID * MV Lower Limit	<i>*oLL</i>	Standard: -5.0 to MV upper limit - 0.1			0.0	%
		Heating/cooling: -105.0 to 0.0			-100.0	
		Close position-proportional control:			0.0	
		-5.0 to MV upper limit - 0.1				
PID * Automatic Selection Range Upper Limit	<i>*Aut</i>	Temperature input: -1,999 to 9,999			0	EU
		Analog input: -5.0 to 105.0			105.0	%
PID * LBA Detection Time	<i>*LbR</i>	0 to 9,999			0	Seconds

### A-6-5 Initial Setting Level

Parameters	Characters	Setting (monitor) value	Display	Default	Unit
Input Type	IN-L	Temperature input 0: Pt100 1: Pt100 2: Pt100 3: JPt100 4: JPt100 5: K 6: K 7: J 8: J 9: T 10: T 11: E 12: L 13: U 14: U 15: N 16: R 17: S 18: B 19: W 20: PLII 21: 10 to 70°C 22: 60 to 120°C 23: 115 to 165°C 24: 140 to 260°C		5	None
		Analog input 25: 4 to 20 mA 26: 0 to 20 mA 27: 1 to 5 V 28: 0 to 5 V 29: 0 to 10 V		5	None
Scaling Upper Limit	IN-H	Scaling lower limit + 1 to 9,999		100	None
Scaling Lower Limit	IN-L	-1,999 to scaling upper limit -1		0	None
Decimal Point	dP	0 to 3		0	None
Temperature Unit	d-U	°C, °F	E, F	°C	None
SP Upper Limit	SL-H	Temperature input: SP lower limit + 1 to Input setting range upper limit		1300	EU
		Analog input: SP lower limit + 1 to scaling upper limit		100	
SP Lower Limit	SL-L	Temperature input: Input setting range lower limit to SP upper limit - 1		-200	EU
		Analog input: Scaling lower limit to SP upper limit - 1		0	
Program Time Unit	E-U	H-M: Hours and minutes M-S: Minutes and seconds	H-M M-S	Hours and minutes	None
Step Time/Rate of Rise Programming:	E-PR	TIME: Step time programming PR: Rate of rise programming	E-TIME PR	Step time programming	None
Time Unit of Ramp Rate	PRU	H: Hours M: Minutes	H M	Min	None
Reset Operation	RESM	STOP: Stop control FSP: Fixed SP operation	STOP FSP	Stop control	None
Startup Operation	P-ON	CONT: Continue RST: Reset Run: Run MANU: Manual Mode	CONT RST RUN MANU	Continue	None
Operation End Operation	ESL	RST: Reset CONT: Continue FSP: Fixed SP Mode	RST CONT FSP	Reset	None
PV Start	PVSL	SP: SP start (SP priority) PV: PV start (slope priority)	SP PV	SP start	
All PID AT Upper Limit SP	ESPU	SP lower limit to SP upper limit		0	EU
PID ON/OFF	ENEL	ON/OFF 2-PID	ON, OFF, PID	PID	None

Parameters	Characters	Setting (monitor) value	Display	Default	Unit
Standard or Heating/Cooling	<i>S-HC</i>	Standard or heating/cooling	<i>StNd, H-C</i>	Standard	None
Control Period (Heating)	<i>CP</i>	0.1, 0.2, 0.5, or 1 to 99	<i>0.1, 0.2, 0.5, 1 to 99</i>	Relay output: 20 Voltage output (for driving SSR): 2	Seconds
Control Period (Cooling)	<i>C-CP</i>	0.1, 0.2, 0.5, or 1 to 99	<i>0.1, 0.2, 0.5, 1 to 99</i>	Relay output: 20 Voltage output (for driving SSR): 2	Seconds
Direct/Reverse Operation	<i>REV</i>	Reverse operation, direct operation	<i>RR-d</i>	Reverse operation	None
Alarm 1 Type	<i>AL1</i>	0: Alarm function OFF 1: Upper and lower-limit alarm 2: Upper-limit alarm 3: Lower-limit alarm 4: Upper and lower-limit range alarm 5: Upper- and lower-limit alarm with standby sequence 6: Upper-limit alarm with standby sequence 7: Lower-limit alarm with standby sequence 8: Absolute-value upper-limit alarm 9: Absolute-value lower-limit alarm 10: Absolute-value upper-limit alarm with standby sequence 11: Absolute-value lower-limit alarm with standby sequence 12: LBA (Loop Burnout Alarm) (A Standard Model must be used.) 13: PV change rate alarm 14: SP absolute-value upper-limit alarm 15: SP absolute-value lower-limit alarm 16: MV absolute-value upper-limit alarm 17: MV absolute-value lower-limit alarm		2	None
Alarm 1 Hysteresis	<i>ALH1</i>	Temperature input: 0.1 to 999.9 for all alarms except for MV absolute-value upper-limit or MV lower-limit alarms		0.2	°C or °F
		Analog input: 0.01 to 99.99 for all alarms except for MV absolute-value upper-limit or MV lower-limit alarms		0.02	%FS
		0.01 to 99.99 for MV absolute-value upper-limit or MV lower-limit alarms		0.50	%
Alarm 2 Type	<i>AL2</i>	Same as Alarm 1 Type except that 12 (LBA) cannot be set.		2	None
Alarm 2 Hysteresis	<i>ALH2</i>	Temperature input: 0.1 to 999.9 for all alarms except for MV absolute-value upper-limit or MV lower-limit alarms		0.2	°C or °F
		Analog input: 0.01 to 99.99 for all alarms except for MV absolute-value upper-limit or MV lower-limit alarms		0.02	%FS
		0.01 to 99.99 for MV absolute-value upper-limit or MV lower-limit alarms		0.50	%
Alarm 3 Type	<i>AL3</i>	Same as Alarm 1 Type except that 12 (LBA) cannot be set.		2	None
Alarm 3 Hysteresis	<i>ALH3</i>	Temperature input: 0.1 to 999.9 for all alarms except for MV absolute-value upper-limit or MV lower-limit alarms		0.2	°C or °F
		Analog input: 0.01 to 99.99 for all alarms except for MV absolute-value upper-limit or MV lower-limit alarms		0.02	%FS
		0.01 to 99.99 for MV absolute-value upper-limit or MV lower-limit alarms		0.50	%



Parameters	Characters	Setting (monitor) value	Display	Default	Unit
Alarm 4 Type	<i>RL4</i>	Same as Alarm 1 Type except that 12 (LBA) cannot be set.		2	None
Alarm 4 Hysteresis	<i>RLH4</i>	Temperature input: 0.1 to 999.9 for all alarms except for MV absolute-value upper-limit or MV lower-limit alarms		0.2	°C or °F
		Analog input: 0.01 to 99.99 for all alarms except for MV absolute-value upper-limit or MV lower-limit alarms		0.02	%FS
		0.01 to 99.99 for MV absolute-value upper-limit or MV lower-limit alarms		0.50	%
Control Output 1 Signal	<i>o15t</i>	4-20: 4-20 mA 0-20: 0-20 mA	<i>4-20, 0-20</i>	4-20	None
Control Output 2 Signal	<i>o25t</i>	4-20: 4-20 mA 0-20: 0-20 mA	<i>4-20, 0-20</i>	4-20	None
Transfer Output Signal	<i>tR5t</i>	4-20: 4-20 mA 1-5V: 1-5 V	<i>4-20, 1-5V</i>	4-20	None
Transfer Output Type	<i>tR-t</i>	OFF: OFF SP-M: Present SP PV: Process value MV: MV (heating) (Not supported for Position-proportional Models.) CMV: MV (cooling) (Supported only for heating/cooling control.) V-M: Valve opening (Supported only for Position-proportional Models.)	<i>oFF</i> <i>SP-M</i> <i>PV</i> <i>MV</i>  <i>C-MV</i>  <i>V-M</i>	OFF	None
Transfer Output Upper Limit	<i>tR-H</i>	*1		*1	*1
Transfer Output Lower Limit	<i>tR-L</i>	*1		*1	*1
Event Input Assignment 1	<i>EV-1</i>	NONE: None RR-1: Run (OFF)/Reset (ON) RR-2: Run (ON)/Reset (OFF) MANU: Auto/Manual Switch RST: Reset RUN: Run HLD1: Hold/clear hold HLD2: Hold ADV: Advance PRG0: Program number switch 0 PRG1: Program number switch 1 PRG2: Program number switch 2 DRS: Invert Direct/Reverse Operation SPM: Program SP Mode/Fixed SP Mode AT-2: 100% AT Execute/Cancel AT-1: 40% AT Execute/Cancel *2 ATA2: All PID 100% AT execute/cancel ATA1: All PID 40% AT execute/cancel *2 WTPT: Setting Change Enable/Disable CMWT: Communications Writing Enable/Disable LAT: Alarm Latch Cancel WAIT: Wait enable (ON)/disable (OFF)	<i>NONE</i> <i>RR-1</i> <i>RR-2</i> <i>MANU</i> <i>RSt</i> <i>RUN</i> <i>HLD1</i> <i>HLD2</i> <i>Adv</i> <i>PRG0</i> <i>PRG1</i> <i>PRG2</i> <i>DRS</i> <i>SPM</i> <i>At-2</i> <i>At-1</i> <i>AtA2</i> <i>AtA1</i> <i>WTPT</i> <i>CMWT</i> <i>LAt</i> <i>WAIt</i>	RR-1	None
Event Input Assignment 2	<i>EV-2</i>	Same as Event Input Assignment 1.	Same as Event Input Assignment 1.	ADV	None
Event Input Assignment 3	<i>EV-3</i>	Same as Event Input Assignment 1.	Same as Event Input Assignment 1.	NONE	None
Event Input Assignment 4	<i>EV-4</i>	Same as Event Input Assignment 1.	Same as Event Input Assignment 1.	NONE	None

Parameters	Characters	Setting (monitor) value	Display	Default	Unit
Event Input Assignment 5	EV-5	Same as Event Input Assignment 1.	Same as Event Input Assignment 1.	NONE	None
Event Input Assignment 6	EV-6	Same as Event Input Assignment 1.	Same as Event Input Assignment 1.	NONE	None
Close/Floating	CLFL	FLOT: Floating control CLOS: Close control	FLOT, CLFS	FLOT	None
Motor Calibration	CRLB	OFF or ON	OFF, ON	OFF	None
Travel Time	MOT	1 to 999		30	Seconds
Valve Completely Closed Position	VL-C	0 to 9,999		0	None
Valve Completely Open Position	VL-O	0 to 9,999		9999	None
Potentiometer Specification Setting	PMS	0 to 5		0	None
Extraction of Square Root Enable	SDR	OFF: ON	OFF, ON	OFF(0)	None
Move to Advanced function Setting Level	AMOV	-1,999 to 9,999		0	None

\*1

Transfer output type	Setting (monitor) range	Default*1.1 (transfer output upper/lower limits)	Unit
Present SP	SP lower limit to SP upper limit	SP upper limit/lower limit	EU
PV	Temperature input: Input setting range lower limit to Input setting range upper limit	Input setting range upper/lower limit	EU
	Analog input: Scaling lower limit to Scaling upper limit	Scaling upper/lower limit	
MV (Heating)	Standard: -5.0 to 105.0 Heating/cooling: 0.0 to 105.0	100.0/0.0	%
MV (Cooling)	0.0 to 105.0	100.0/0.0	%
Valve opening	-10.0 to 110.0	100.0/0.0	%

\*1.1 Initialized when the transfer output type is changed.

Initialized if the input type, temperature unit, scaling upper/lower limit, or SP upper/lower limit is changed when the transfer output type is SP or PV.

(When initialized by the initializing settings, it is initialized to 100.0/0.0.)

\*2 This function can be set for heating/cooling control or for floating control for Position-proportional Models, but the setting will be disabled.

### A-6-6 Manual Control Level

Parameters	Setting (monitor) value	Default	Unit
Manual MV	-5.0 to 105.0 (standard)*1 -105.0 to 105.0 (heating/cooling)*2 -5.0 to 105.0 (position-proportional)*1*2	0.0	%

\*1 When the Manual MV Limit Enable parameter is set to ON, the setting range will be the MV lower limit to the MV upper limit.

\*2 The valve opening is monitored for floating control or for close control with the Direct Setting of Position-proportional MV parameter set to OFF.

### A-6-7 Monitor/Setting Item Level

The contents displayed vary depending on the Monitor/Setting 1 to 5 (advanced function setting level) setting.

**A-6-8 Advanced Function Setting Level**

Parameters	Characters	Setting (monitor) value	Display	Default	Unit
Parameter Initialization	<i>INCL</i>	OFF, FACT	<i>OFF, FRCt</i>	OFF	None
Program End ON Time	<i>PENd</i>	ON: Continue output, 0.0: No output, or 0.1 to 10.0	<i>ON, 0.0, or 0.1 to 10.0</i>	0.0	Seconds
Standby Time Unit	<i>S-U</i>	H-M: Hours and minutes M-S: Minutes and seconds	<i>H-M M-S</i>	Hours and minutes	None
Standby Sequence Reset	<i>RESL</i>	Condition A, condition B	<i>A, b</i>	Condition A	None
Auxiliary Output 1 Open in Alarm	<i>Sb1N</i>	N-O: Close in alarm N-C: Open in alarm	<i>N-O, N-C</i>	N-O	None
Auxiliary Output 2 Open in Alarm	<i>Sb2N</i>	N-O: Close in alarm N-C: Open in alarm	<i>N-O, N-C</i>	N-O	None
Auxiliary Output 3 Open in Alarm	<i>Sb3N</i>	N-O: Close in alarm N-C: Open in alarm	<i>N-O, N-C</i>	N-O	None
Auxiliary Output 4 Open in Alarm	<i>Sb4N</i>	N-O: Close in alarm N-C: Open in alarm	<i>N-O, N-C</i>	N-O	None
HB ON/OFF	<i>HbU</i>	OFF, ON	<i>OFF, ON</i>	ON	None
Heater Burnout Latch	<i>HbL</i>	OFF, ON	<i>OFF, ON</i>	OFF	None
Heater Burnout Hysteresis	<i>HbH</i>	0.1 to 50.0		0.1	A
$\alpha$	<i>ALFA</i>	0.00 to 1.00		0.65	None
Integral/Derivative Time Unit	<i>ICDU</i>	1, 0.1	<i>1, 0.1</i>	1	Second
AT Calculated Gain	<i>RE-G</i>	0.1to 10.0		Standard Model: 0.8 Position-proportional Model: 1.0	None
AT Hysteresis	<i>RE-H</i>	Temperature input: 0.1 to 999.9		0.8 (for °C) 1.4 (for °F)	°C or °F
		Analog input: 0.01 to 9.99		0.20	%FS
Limit Cycle MV Amplitude	<i>LCMA</i>	5.0 to 50.0		20.0	%
Input Digital Filter	<i>INF</i>	0.0 to 999.9		0.0	Second
Moving Average Count	<i>MAV</i>	OFF, 2, 4, 8, 16, or 32		OFF	Times
Automatic Display Return Time	<i>REt</i>	OFF, 1 to 99	<i>OFF, 1 to 99</i>	OFF	Second
Display Brightness	<i>BRGt</i>	1 to 3		3	None
Alarm 1 Latch	<i>R1Lt</i>	OFF, ON	<i>OFF, ON</i>	OFF	None
Alarm 2 Latch	<i>R2Lt</i>	OFF, ON	<i>OFF, ON</i>	OFF	None
Alarm 3 Latch	<i>R3Lt</i>	OFF, ON	<i>OFF, ON</i>	OFF	None
Alarm 4 Latch	<i>R4Lt</i>	OFF, ON	<i>OFF, ON</i>	OFF	None
Move to Protect Level Time	<i>PRLt</i>	1 to 30		3	Second
Cold Junction Compensation Method	<i>CLC</i>	OFF, ON	<i>OFF, ON</i>	ON	None
Alarm 1 ON Delay	<i>R1ON</i>	0 to 999 (0: ON delay disabled)		0	Second
Alarm 2 ON Delay	<i>R2ON</i>	0 to 999 (0: ON delay disabled)		0	Second
Alarm 3 ON Delay	<i>R3ON</i>	0 to 999 (0: ON delay disabled)		0	Second
Alarm 4 ON Delay	<i>R4ON</i>	0 to 999 (0: ON delay disabled)		0	Second
Alarm 1 OFF Delay	<i>R1OF</i>	0 to 999 (0: OFF delay disabled)		0	Second
Alarm 2 OFF Delay	<i>R2OF</i>	0 to 999 (0: OFF delay disabled)		0	Second
Alarm 3 OFF Delay	<i>R3OF</i>	0 to 999 (0: OFF delay disabled)		0	Second
Alarm 4 OFF Delay	<i>R4OF</i>	0 to 999 (0: OFF delay disabled)		0	Second
Manual Output Method	<i>MANL</i>	HOLD or INIT	<i>HOLD, INCL</i>	HOLD	None
Manual MV Initial Value	<i>MANL</i>	-5.0 to 105.0 for standard control *1 -105.0 to 105.0 for heating/cooling control *1		0.0	%
RT	<i>REt</i>	OFF, ON	<i>OFF, ON</i>	OFF	None

Parameters	Characters	Setting (monitor) value	Display	Default	Unit
HS Alarm Use	<i>HSU</i>	OFF, ON	<i>OFF, ON</i>	ON	None
HS Alarm Latch	<i>HSL</i>	OFF, ON	<i>OFF, ON</i>	OFF	None
HS Alarm Hysteresis	<i>HSH</i>	0.1 to 50.0		0.1	A
LBA Detection Time	<i>LbR</i>	0 to 9999 (0: LBA function disabled)		0	Second
LBA Level	<i>LbRL</i>	Temperature input: 0.1 to 999.9		8.0	°C or °F
		Analog input: 0.01 to 99.99		10.00	%FS
LBA Band	<i>LbRb</i>	Temperature input: 0.0 to 999.9		3.0	°C or °F
		Analog input: 0.00 to 99.99		0.20	%FS
Control Output 1 Assignment	<i>OUT 1</i>	Relay Output or Voltage Output (for Driving SSR) *2 NONE: No assignment O: Control output (heating) C-O: Control output (cooling) ALM1: Alarm 1 ALM2: Alarm 2 ALM3: Alarm 3 ALM4: Alarm 4 HA: Heater alarm (HB + HS) HB: Heater burnout alarm (HB) HS: Heater short alarm (HS) S.ERR: Input error P.END: Program End output STG: Stage output RUN: RUN output TS1: Time signal 1 output TS2: Time signal 2 output ALM: Integrated alarm WR1: Work bit 1 *3 WR2: Work bit 2 *3 WR3: Work bit 3 *3 WR4: Work bit 4 *3 WR5: Work bit 5 *3 WR6: Work bit 6 *3 WR7: Work bit 7 *3 WR8: Work bit 8 *3 For Linear Current Output *2 NONE: Not assigned. O: Control output (heating) C-O: Control output (cooling)	<i>NONE</i> <i>o</i> <i>C-o</i> <i>ALM 1</i> <i>ALM 2</i> <i>ALM 3</i> <i>ALM 4</i> <i>HA</i> <i>HB</i> <i>HS</i> <i>S.ERR</i> <i>P.END</i> <i>STG</i> <i>RUN</i> <i>TS 1</i> <i>TS 2</i> <i>ALM</i> <i>WR 1</i> <i>WR 2</i> <i>WR 3</i> <i>WR 4</i> <i>WR 5</i> <i>WR 6</i> <i>WR 7</i> <i>WR 8</i>  <i>NONE</i> <i>o</i> <i>C-o</i>	0	None
Control Output 2 Assignment	<i>OUT 2</i>	Same as the Control Output 1 Assignment parameter.	Same as the Control Output 1 Assignment parameter.	NONE	None

Parameters	Characters	Setting (monitor) value	Display	Default	Unit
Auxiliary Output 1 Assignment	<i>SUB1</i>	NONE: No assignment O: Control output (heating) C-O: Control output (cooling) ALM1: Alarm 1 ALM2: Alarm 2 ALM3: Alarm 3 ALM4: Alarm 4 HA: Heater alarm (HB + HS) HB: Heater burnout alarm (HB) HS: Heater short alarm (HS) S.ERR: Input error P.END: Program end output STG: Stage output RUN: RUN output TS1: Time signal 1 output TS2: Time signal 2 output ALM: Integrated alarm WR1: Work bit 1 *3 WR2: Work bit 2 *3 WR3: Work bit 3 *3 WR4: Work bit 4 *3 WR5: Work bit 5 *3 WR6: Work bit 6 *3 WR7: Work bit 7 *3 WR8: Work bit 8 *3	<i>NONE</i> <i>0</i> <i>C-0</i> <i>ALM1</i> <i>ALM2</i> <i>ALM3</i> <i>ALM4</i> <i>HA</i> <i>HB</i> <i>HS</i> <i>S.ERR</i> <i>P.END</i> <i>STG</i> <i>RUN</i> <i>TS1</i> <i>TS2</i> <i>ALM</i> <i>WR1</i> <i>WR2</i> <i>WR3</i> <i>WR4</i> <i>WR5</i> <i>WR6</i> <i>WR7</i> <i>WR8</i>	ALM1 *Controllers without HB and HS alarm detection: HA	None
Auxiliary Output 2 Assignment	<i>SUB2</i>	Same as the Auxiliary Output 1 Assignment parameter.	Same as the Auxiliary Output 1 Assignment parameter.	ALM2	None
Auxiliary Output 3 Assignment	<i>SUB3</i>	Same as the Auxiliary Output 1 Assignment parameter.	Same as the Auxiliary Output 1 Assignment parameter.	ALM3	None
Auxiliary Output 4 Assignment	<i>SUB4</i>	Same as the Auxiliary Output 1 Assignment parameter.	Same as the Auxiliary Output 1 Assignment parameter.	ALM4	None
Integrated Alarm Assignment	<i>ALMR</i>	0 to 255 Alarm 1: +1 Alarm 2: +2 Alarm 3: +4 Alarm 4: +8 HB alarm: +16 HS alarm: +32 Input error: +64 Not used: +128		49	None
Alarm SP Selection	<i>ALSP</i>	SP-M: Present SP TSP: Segment SP	<i>SP-M, TSP</i>	SP-M	None
SP Tracking	<i>SPTR</i>	OFF, ON	<i>OFF, ON</i>	OFF	None
PID Set Automatic Selection Data	<i>PIDC</i>	PV, deviation, or SP	<i>PV, dV, SP</i>	PV	None
PID Set Automatic Selection Hysteresis	<i>PIDH</i>	0.10 to 99.99		0.50	%FS
PV Dead Band	<i>PVdb</i>	0 to 9999		0	EU
Manual MV Limit Enable	<i>MANL</i>	OFF, ON	<i>OFF, ON</i>	OFF	None

Parameters	Characters	Setting (monitor) value	Display	Default	Unit
Direct Setting of Position Proportional MV	<i>PMVd</i>	OFF, ON	<i>OFF, ON</i>	OFF	None
PV Rate of Change Calculation Period	<i>PVrP</i>	1 to 999		20	Sampling period
Heating/Cooling Tuning Method	<i>HCLM</i>	0: Same as heating control 1: Linear 2: Air cooling 3: Water cooling		0	None
Minimum Output ON/OFF Band	<i>OMPW</i>	0.0 to 50.0		1.0	%
LCT Cooling Output Min. ON Time	<i>LCLt</i>	0.1 to 1.0		0.2	Seconds
PF Setting	<i>PF</i>	OFF: OFF RUN: RUN RST: Reset R-R: Run/reset HOLD: Hold/clear hold ADV: Advance AT-2: 100% AT execute/cancel AT-1: 40% AT execute/cancel ATA2: All PID 100% AT execute/cancel ATA1: All PID 40% AT execute/cancel LAT: Alarm Latch Cancel A-M: Auto/manual PFDP: Monitor/setting item SHFT: Digit Shift Key	<i>OFF RUN RSt R-R HOLD AdV Rt-2 Rt-1 RtR2 RtR1 LRt R-M PFdP SHFt</i>	SHFT	None
PF Monitor/Setting Item 1	<i>PFd1</i>	0: Disabled 1: PV/SP/Multi-SP/Program No. monitor and segment No. monitor 2: PV/SP/MV (heating) (valve opening for Position-proportional Models) 3: PV/SP/MV monitor (cooling) 4: PV/SP/Remaining segment time 5: Program Number 6: Segment No. monitor 7: Remaining standby time monitor 8: Elapsed program time monitor 9: Remaining program time monitor 10: Elapsed segment time monitor 11: Remaining segment time monitor 12: Program execution repetitions monitor 13: Proportional band 14: Integral time 15: Derivative time 16: Proportional band (cooling) 17: Integral time (cooling) 18: Derivative time (cooling) 19: Alarm value 1 20: Alarm value upper limit 1 21: Alarm value lower limit 1 22: Alarm value 2 23: Alarm value upper limit 2 24: Alarm value lower limit 2 25: Alarm value 3 26: Alarm value upper limit 3 27: Alarm value lower limit 3 28: Alarm value 4 29: Alarm value upper limit 4 30: Alarm value lower limit 4		1	None
PF Monitor/Setting Item 2	<i>PFd2</i>	Same as Monitor/Setting Item 1.		0	None
PF Monitor/Setting Item 3	<i>PFd3</i>	Same as Monitor/Setting Item 1.		0	None
PF Monitor/Setting Item 4	<i>PFd4</i>	Same as Monitor/Setting Item 1.		0	None
PF Monitor/Setting Item 5	<i>PFd5</i>	Same as Monitor/Setting Item 1.		0	None

Parameters	Characters	Setting (monitor) value	Display	Default	Unit
PV/SP No. 1 Display Selection	<i>SPd1</i>	0: Nothing is displayed. 1: PV/SP/Nothing displayed 2: PV/Nothing displayed/Nothing displayed 3: SP/SP (character display)/Nothing displayed 4: PV/SP/MV (heating) (valve opening for Position-proportional Models) 5: PV/SP/MV monitor (cooling) 6: PV/SP/Program number and segment number 7: PV/SP/Remaining segment time		6	None
PV/SP No. 2 Display Selection	<i>SPd2</i>	Same as PV/SP No. 1 Display Selection.		E5CC-T: 0, E5EC-T/E5A C-T: 7	None
PV Status Display Function	<i>PVSt</i>	OFF: OFF MANU: Manual RST: Reset ALM1: Alarm 1 ALM2: Alarm 2 ALM3: Alarm 3 ALM4: Alarm 4 ALM: OR of alarms 1 to 4 HA: Heater alarm STB: Standby	<i>OFF</i> <i>MANU</i> <i>RSt</i> <i>ALM1</i> <i>ALM2</i> <i>ALM3</i> <i>ALM4</i> <i>ALM</i> <i>HA</i> <i>Stb</i>	OFF	None
SV Status Display Function	<i>SVSt</i>	OFF: OFF MANU: Manual RST: Reset ALM1: Alarm 1 ALM2: Alarm 2 ALM3: Alarm 3 ALM4: Alarm 4 ALM: OR of alarms 1 to 4 HA: Heater alarm STB: Standby	<i>OFF</i> <i>MANU</i> <i>RSt</i> <i>ALM1</i> <i>ALM2</i> <i>ALM3</i> <i>ALM4</i> <i>ALM</i> <i>HA</i> <i>Stb</i>	OFF	None
Display Refresh Period	<i>dREF</i>	OFF, 0.25, 0.5, 1.0	<i>OFF, 0.25, 0.5, 1.0</i>	0.25	Second
Burnout Method	<i>bURN</i>	Upscale or downscale	<i>UP, dOWN</i>	Upscale	None
Parameter Mask Settings	<i>PMSE</i>	OFF, ON	<i>OFF, ON</i>	OFF	None
Move to Calibration Level	<i>CMdV</i>	-1999 to 9999		0	None

- \*1 If the Manual MV Limit Enable parameter is set to ON, the setting range will be the MV lower limit to the MV upper limit.
- \*2 The setting ranges are different for relay and voltage outputs (for driving SSR) and for linear current outputs.
- \*3 WR1 to WR8 are not displayed when the logic operation function is not used.

### A-6-9 Protect Level

Parameters	Characters	Setting (monitor) value	Display	Default	Unit
Move to Protect level	<i>PMdV</i>	-1999 to 9999		0	None
Operation/Adjustment Protect	<i>oAPt</i>	0 to 5		0	None
Initial Setting/Communications Protect	<i>iCPt</i>	0 to 2		1	None
Setting Change Protect	<i>WtPt</i>	OFF, ON	<i>OFF, ON</i>	OFF	None
PF Key Protect	<i>PFPt</i>	OFF, ON	<i>OFF, ON</i>	OFF	None
Parameter Mask Enable	<i>PMSE</i>	OFF, ON	<i>OFF, ON</i>	ON	None
Password to Move to Protect Level	<i>PRLP</i>	-1,999 to 9,999		0	None

## A-6-10 Communications Setting Level

Parameters	Characters	Setting (monitor) value	Display	Default	Unit
Protocol Setting	<i>PSEL</i>	CWF: CompoWay/F MOD: Modbus CMP: Component communications FINS: Host Link (FINS) MCP4: MC Protocol (Type 4)	<i>CWF</i> <i>Mod</i> <i>CMP</i> <i>FINS</i> <i>MCP4</i>	CompoWay/ F	None
Communications Unit No.	<i>U-Nō</i>	0 to 99		1	None
Communications Baud Rate	<i>bPS</i>	9.6, 19.2, 38.4, or 57.6	<i>9.6, 19.2,</i> <i>38.4, 57.6</i>	9.6	kbps
Communications Data Length	<i>LEN</i>	7, 8		7	Bit
Communications Stop Bits	<i>StLt</i>	1, 2		2	Bit
Communications Parity	<i>PRtY</i>	NONE: None EVEN: Even ODD: Odd	<i>NōNE, EVEN,</i> <i>ōdd</i>	Even	None
Send Data Wait Time	<i>SdWt</i>	0 to 99		20	ms
Highest Communications Unit No.	<i>MRxU</i>	0 to 99		0	None
Area	<i>ARER</i>	0 to 25		0	None
First Address Upper Word	<i>AdRH</i>	0 to 99		0	None
First Address Lower Word	<i>AdRL</i>	0 to 9999		0	None
Receive Data Wait Time	<i>RdWt</i>	100 to 9999		1000	ms
Communications Node Number	<i>UNLt</i>	0 to 99		0	None
Upload Settings 1 to 23	<i>UP 1 to 23</i>	0 to 179			None
Download Settings 1 to 43	<i>dN 1 to 43</i>	30 to 179			None
Copy	<i>CōPY</i>	OFF, ALL, or 1 to 31		OFF	None



### A-6-11 Initialization According to Parameter Changes

The parameters that are initialized when parameters are changed are shown under Related initialized parameters.

Changed parameter \ Related initialized parameters	Input Type	Temperature Unit	Scaling Lower Limit	Scaling Upper Limit	SP Lower Limit	SP Upper Limit	PID ON/OFF	Standard or Heating/Cooling	Transfer Output Type	Close/Floating	RT	Direct Setting of Position Proportional MV	PID Set Automatic Selection Data	Integral/Derivative Time Unit	Alarm 1 Type	Alarm 2 Type	Alarm 3 Type	Alarm 4 Type	Program Time Unit	Startup Operation	Operation End Operation	Step Time/Rate of Rise Programming	Time Unit of Ramp Rate	Reset Operation	Standby Time Unit	Heating/Cooling Tuning Method	Password to Move to Protect Level	Run/Reset
SP Upper Limit	●	●	●	---	---	---	---	---	---	---	---	---	---	---	---	---	---	---	---	---	---	---	---	---	---	---	---	---
SP Lower Limit	*1	*1	*1	---	---	---	---	---	---	---	---	---	---	---	---	---	---	---	---	---	---	---	---	---	---	---	---	---
Segment SP	●	●	●	●	●	---	---	---	---	---	---	---	---	---	---	---	---	---	---	---	---	---	---	---	---	---	---	---
RT	●	---	---	---	---	---	---	---	---	---	---	---	---	---	---	---	---	---	---	---	---	---	---	---	---	---	---	---
Integral/Derivative Time Unit	---	---	---	---	---	---	---	---	---	---	●	---	---	---	---	---	---	---	---	---	---	---	---	---	---	---	---	---
MV at Reset	---	---	---	---	---	---	---	●	---	●	---	●	---	---	---	---	---	---	---	---	---	---	---	---	---	---	---	---
MV at PV Error	---	---	---	---	---	---	---	●	---	●	---	●	---	---	---	---	---	---	---	---	---	---	---	---	---	---	---	---
Manual MV	---	---	---	---	---	---	---	---	---	●	---	●	---	---	---	---	---	---	---	---	---	---	---	---	---	---	---	---
Manual MV Initial Value	---	---	---	---	---	---	---	●	---	---	---	---	---	---	---	---	---	---	---	---	---	---	---	---	---	---	---	---
Transfer Output Upper Limit, Transfer Output Lower Limit	●	●	●	●	●	---	---	●	●	---	---	---	---	---	---	---	---	---	---	---	---	---	---	---	---	---	---	---
SP Mode	---	---	---	---	---	---	---	---	---	---	---	---	---	---	---	---	---	---	---	---	---	---	---	●	---	---	---	---
Fixed SP	●	●	●	●	●	---	---	---	---	---	---	---	---	---	---	---	---	---	---	---	---	---	---	---	---	---	---	---
All PID AT Upper Limit	●	●	●	●	●	---	---	---	---	---	---	---	---	---	---	---	---	---	---	---	---	---	---	---	---	---	---	---
SP	*8	*8	*8	*8	---	---	---	---	---	---	---	---	---	---	---	---	---	---	---	---	---	---	---	---	---	---	---	---
Standby Time	---	---	---	---	---	---	---	---	---	---	---	---	---	---	---	---	---	---	---	---	---	---	---	---	●	---	---	---
Control Output 1 Assignment	---	---	---	---	---	---	---	●	---	---	---	---	---	---	---	---	---	---	---	---	---	---	---	---	---	---	---	---
Control Output 2 Assignment	---	---	---	---	---	---	---	●	---	---	---	---	---	---	---	---	---	---	---	---	---	---	---	---	---	---	---	---
Auxiliary Output 1 Assignment	---	---	---	---	---	---	---	●	---	---	---	---	---	---	---	---	---	---	---	---	---	---	---	---	---	---	---	---
Auxiliary Output 2 Assignment	---	---	---	---	---	---	---	●	---	---	---	---	---	---	---	---	---	---	---	---	---	---	---	---	---	---	---	---
Auxiliary Output 3 Assignment	---	---	---	---	---	---	---	●	---	---	---	---	---	---	---	---	---	---	---	---	---	---	---	---	---	---	---	---
Auxiliary Output 4 Assignment	---	---	---	---	---	---	---	●	---	---	---	---	---	---	---	---	---	---	---	---	---	---	---	---	---	---	---	---
Move to Protect Level	---	---	---	---	---	---	---	---	---	---	---	---	---	---	---	---	---	---	---	---	---	---	---	---	---	---	●	---
Position Proportional Dead Band	---	---	---	---	---	---	---	---	---	●	---	---	---	---	---	---	---	---	---	---	---	---	---	---	---	---	---	---
Dead Band	●	---	---	---	---	---	---	---	---	---	---	---	---	---	---	---	---	---	---	---	---	---	---	---	---	---	---	---
Hysteresis (Heating)	*13	---	---	---	---	---	---	---	---	---	---	---	---	---	---	---	---	---	---	---	---	---	---	---	---	---	---	---
Hysteresis (Cooling)	*13	---	---	---	---	---	---	---	---	---	---	---	---	---	---	---	---	---	---	---	---	---	---	---	---	---	---	---
Wait Band	●	---	---	---	---	---	---	---	---	---	---	---	---	---	---	---	---	---	---	---	---	---	---	---	---	---	---	---
Alarm 1 Hysteresis	*14	---	---	---	---	---	---	---	---	---	---	---	---	---	---	---	---	---	---	---	---	---	---	---	---	---	---	---
Alarm 2 Hysteresis	●	---	---	---	---	---	---	---	---	---	---	---	---	---	---	---	---	---	---	---	---	---	---	---	---	---	---	---
Alarm 3 Hysteresis	*14	---	---	---	---	---	---	---	---	---	---	---	---	---	---	---	---	---	---	---	---	---	---	---	---	---	---	---

Changed parameter \ Related initialized parameters	Input Type	Temperature Unit	Scaling Lower Limit	Scaling Upper Limit	SP Lower Limit	SP Upper Limit	PID ON/OFF	Standard or Heating/Cooling	Transfer Output Type	Close/Floating	RT	PID Set Automatic Selection Data	Direct Setting of Position Proportional MV	Integral/Derivative Time Unit	Alarm 1 Type	Alarm 2 Type	Alarm 3 Type	Alarm 4 Type	Program Time Unit	Startup Operation	Operation End Operation	Step Time/Rate of Rise Programming	Time Unit of Ramp Rate	Reset Operation	Standby Time Unit	Heating/Cooling Tuning Method	Password to Move to Protect Level	Run/Reset
Alarm 4 Hysteresis	● <sup>*14</sup>	---	---	---	---	---	---	---	---	---	---	---	---	---	---	---	---	● <sup>*15</sup>	---	---	---	---	---	---	---	---	---	---
AT Hysteresis	● <sup>*13</sup> ● <sup>*18</sup>	● <sup>*18</sup>	---	---	---	---	---	---	---	---	---	---	---	---	---	---	---	---	---	---	---	---	---	---	---	---	---	---
LBA Level	● <sup>*13</sup>	---	---	---	---	---	---	---	---	---	---	---	---	---	---	---	---	---	---	---	---	---	---	---	---	---	---	---
LBA Band	● <sup>*13</sup>	---	---	---	---	---	---	---	---	---	---	---	---	---	---	---	---	---	---	---	---	---	---	---	---	---	---	---
Startup Operation	---	---	---	---	---	---	● <sup>*17</sup>	---	---	---	---	---	---	---	---	---	---	---	---	---	---	---	---	---	---	---	---	---
Operation End Operation	---	---	---	---	---	---	---	---	---	---	---	---	---	---	---	---	---	---	---	---	---	---	---	● <sup>*16</sup>	---	---	---	---
Proportional Band	● <sup>*13</sup>	---	---	---	---	---	---	---	---	● <sup>*9</sup>	---	---	---	● <sup>*19</sup>	---	---	---	---	---	---	---	---	---	---	---	---	---	---
Proportional Band (Cooling)	● <sup>*13</sup>	---	---	---	---	---	---	---	---	● <sup>*9</sup>	---	---	---	● <sup>*19</sup>	---	---	---	---	---	---	---	---	---	---	---	---	---	---
Integral Time	● <sup>*13</sup>	---	---	---	---	---	---	---	---	● <sup>*21</sup>	● <sup>*9</sup>	---	---	● <sup>*19</sup>	---	---	---	---	---	---	---	---	---	---	---	---	---	---
Integral Time (Cooling)	● <sup>*13</sup>	---	---	---	---	---	---	---	---	---	● <sup>*9</sup>	---	---	● <sup>*19</sup>	---	---	---	---	---	---	---	---	---	---	---	---	---	---
Derivative Time	● <sup>*13</sup>	---	---	---	---	---	---	---	---	---	● <sup>*9</sup>	---	---	● <sup>*19</sup>	---	---	---	---	---	---	---	---	---	---	---	---	---	---
Derivative Time (Cooling)	● <sup>*13</sup>	---	---	---	---	---	---	---	---	---	● <sup>*9</sup>	---	---	● <sup>*19</sup>	---	---	---	---	---	---	---	---	---	---	---	---	---	---
MV Upper Limit	---	---	---	---	---	---	---	● <sup>*5</sup>	---	---	---	---	---	---	---	---	---	---	---	---	---	---	---	---	---	---	---	---
MV Lower Limit	---	---	---	---	---	---	---	● <sup>*5</sup>	---	---	---	---	---	---	---	---	---	---	---	---	---	---	---	---	---	---	---	---
Automatic Selection Range Upper Limit	● <sup>*12</sup>	● <sup>*12</sup>	---	---	---	---	---	---	---	---	---	● <sup>*12</sup>	---	---	---	---	---	---	---	---	---	---	---	---	---	---	---	---
Program Start (Run/Reset)	---	---	---	---	---	---	● <sup>*17</sup>	---	---	---	---	---	---	---	---	---	---	---	●	●	●	●	●	●	●	---	---	---
Auto/Manual	---	---	---	---	---	---	● <sup>*17</sup>	---	---	---	---	---	---	---	---	---	---	---	---	---	---	---	---	---	---	---	---	---
Hold	---	---	---	---	---	---	● <sup>*17</sup>	---	---	---	---	---	---	---	---	---	---	---	●	●	●	●	●	●	●	---	---	●
Minimum Output ON/OFF Band	---	---	---	---	---	---	---	● <sup>*22</sup>	---	---	---	---	---	---	---	---	---	---	---	---	---	---	---	---	---	● <sup>*22</sup>	---	---

\*1 Initialized to input setting range upper and lower limits, or scaling upper and lower limits.  
 \*2 Clamped by SP upper and lower limits.  
 \*3 This parameter is initialized only if the input type is changed to analog input when the RT parameter is ON. The RT parameter turns OFF.  
 \*4 Initialization is performed as shown below according to the transfer output type setting. The initialization differs depending on the changed parameter and the output type setting.  
 • Present SP: SP upper and lower limits  
 • PV: Input setting range upper and lower limits or scaling upper and lower limits  
 • MV (Heating): 100.0/0.0  
 • MV (Cooling): 100.0/0.0  
 • Valve opening: 100.0/0.0  
 \*4.1 Initialized only when the Transfer Output Type parameter is set to Present SP.  
 \*4.2 Initialized only when the Transfer Output Type parameter is set to Present SP or PV.  
 \*4.3 Initialized only when the Transfer Output Type parameter is set to MV (Heating) or MV (Cooling).  
 \*4.4 Initialized to the above default values regardless of the settings for changing the transfer output type.  
 \*5 Initialized as follows according to the Standard or Heating/Cooling parameter setting.  
 • MV Upper Limit: 100.0

- MV Lower Limit: Standard 0.0, heating/cooling –100.0
- \*6 For heating and cooling control, initialized to Control Output (Cooling) as follows:  
(The defaults for standard control are the defaults in the parameter list.)
- With control output 2: The Control Output 2 Assignment parameter is initialized to control output (cooling).
  - If the Controller does not have control output 2 but has four auxiliary outputs, the Auxiliary Output 4 Assignment parameter is initialized to Control Output (Cooling).
  - Otherwise, the Auxiliary Output 2 Assignment parameter is initialized to Control Output (Cooling).
- \*7 The Auxiliary Output 1 Assignment parameter is initialized as follows:
- Controllers with HB and HS alarms: Heater alarm
  - Controllers without HB and HS alarms: Alarm 1
- \*8 The All PID AT upper limit SP is clamped to the input setting range upper or lower limit, or the scaling upper or lower limit.
- \*9 For a temperature input, the Integral/Derivative Time Unit parameter is initialized only when the RT parameter is turned ON. The default is as follows:
- Integral/Derivative Time Unit: 0.1 s (The PID parameters are also initialized when the Integral/Derivative Time Unit parameter is initialized.)<sup>\*19</sup>
- \*10 This parameter is initialized to the new Password to Move to Protect Level password.
- \*11 If you change the reset operation from stopping control to fixed control, the SP Mode is initialized to FSP if it was PSP.
- \*12 The defaults are as follows:
- Temperature input: The upper and lower limits of the input setting range change to the following values according to the temperature unit and based on the setting of the PID Set Automatic Selection Data parameter.
- PID Set Automatic Selection Data set to PV: Input setting range upper limit + 20°C (40°F)
  - PID Set Automatic Selection Data set to DV: Input setting range upper limit – Input setting range lower limit + 20°C (40°F)
  - PID Set Automatic Selection Data set to SP: Input setting range upper limit
- Analog input: 105.0 (regardless of the setting of the PID Set Automatic Selection Data parameter)
- \*13 These parameters are initialized when the Input Type parameter is changed from a temperature input to an analog input or from an analog input to a temperature input.
- \*14 This parameter is initialized when the Input Type parameter is changed from a temperature input to an analog input or from an analog input to a temperature input. However, it is not initialized if the applicable alarm is an MV absolute-value upper-limit alarm or an MV absolute-value lower-limit alarm.
- \*15 This parameter is initialized to 50 (0.50%) if a non-MV alarm is changed to an MV alarm. This parameter is initialized to 2 (0.2°C or 0.02%FS) if an MV alarm is changed to a non-MV alarm.
- \*16 The Operation End Operation parameter is initialized when the Reset Operation parameter is set to fixed SP operation.
- \*17 Initialized only when the PID ON/OFF parameter is set to ON/OFF control.
- \*18 Initialized to 0.8 when the temperature unit is °C, and to 1.4 when the temperature unit is °F.
- \*19 These parameters are initialized as follows:
- Integral/Derivative Time Unit of 1 s: Proportional band to 8, integral time to 233, and derivative time to 40. (This applies to both the heating and cooling constants.)
  - Integral/Derivative Time Unit of 0.1 s: Proportional band to 8.0, integral time to 233.0, and derivative time to 40.0. (This applies to both the heating and cooling constants.)
- \*20 This parameter is initialized to 4.0 for closed control and 2.0 for floating control.
- \*21 If the Close/Floating parameter is set to floating and the integral time is 0, the parameter is initialized to 233. If the integral time is 0.0, it is initialized to 233.0.
- \*22 The Minimum Output ON/OFF Band parameter is initialized as follows depending on the settings of the Standard or Heating/Cooling and Heating/Cooling Tuning Method parameters:
- Standard or Heating/Cooling parameter set to Standard: 1.0
  - Standard or Heating/Cooling parameter set to Heating/Cooling and Heating/Cooling Tuning Method parameter set to Same as Heating Control: 1.0
  - Standard or Heating/Cooling parameter set to Heating/Cooling and Heating/Cooling Tuning Method parameter set to Linear: 1.0
  - Standard or Heating/Cooling parameter set to Heating/Cooling and Heating/Cooling Tuning Method parameter set to Air Cooling: 0.0
  - Standard or Heating/Cooling parameter set to Heating/Cooling and Heating/Cooling Tuning Method parameter set to Water Cooling: 0.0

# A-7 Sensor Input Setting Range, Indication Range, Control Range

	Specifications	Set value	Input setting range	Input indication range	
Resistance thermometer	Pt100	0	-200 to 850 (°C)/-300 to 1500 (°F)	-220 to 870 (°C)/-340 to 1540 (°F)	
		1	-199.9 to 500.0 (°C)/-199.9 to 900.0 (°F)	-199.9 to 520.0 (°C)/-199.9 to 940.0 (°F)	
	JPt100	2	0.0 to 100.0 (°C)/0.0 to 210.0 (°F)	-20.0 to 120.0 (°C)/-40.0 to 250.0 (°F)	
		3	-199.9 to 500.0 (°C)/-199.9 to 900.0 (°F)	-199.9 to 520.0 (°C)/-199.9 to 940.0 (°F)	
Thermocouple	K	4	0.0 to 100.0 (°C)/0.0 to 210.0 (°F)	-20.0 to 120.0 (°C)/-40.0 to 250.0 (°F)	
		5	-200 to 1300 (°C)/-300 to 2300 (°F)	-220 to 1320 (°C)/-340 to 2340 (°F)	
	J	6	-20.0 to 500.0 (°C)/0.0 to 900.0 (°F)	-40.0 to 520.0 (°C)/-40.0 to 940.0 (°F)	
		7	-100 to 850 (°C)/-100 to 1500 (°F)	-120 to 870 (°C)/-140 to 1540 (°F)	
	T	8	-20.0 to 400.0 (°C)/0.0 to 750.0 (°F)	-40.0 to 420.0 (°C)/-40.0 to 790.0 (°F)	
		9	-200 to 400 (°C)/-300 to 700 (°F)	-220 to 420 (°C)/-340 to 740 (°F)	
	E	10	-199.9 to 400.0 (°C)/-199.9 to 700.0 (°F)	-199.9 to 420.0 (°C)/-199.9 to 740.0 (°F)	
		11	-200 to 600 (°C)/-300 to 1100 (°F)	-220 to 620 (°C)/-340 to 1140 (°F)	
	L	12	-100 to 850 (°C)/-100 to 1500 (°F)	-120 to 870 (°C)/-140 to 1540 (°F)	
		13	-200 to 400 (°C)/-300 to 700 (°F)	-220 to 420 (°C)/-340 to 740 (°F)	
	U	14	-199.9 to 400.0 (°C)/-199.9 to 700.0 (°F)	-199.9 to 420.0 (°C)/-199.9 to 740 (°F)	
		15	-200 to 1300 (°C)/-300 to 2300 (°F)	-220 to 1320 (°C)/-340 to 2340 (°F)	
	R	16	0 to 1700 (°C)/0 to 3000 (°F)	-20 to 1720 (°C)/-40 to 3040 (°F)	
		17	0 to 1700 (°C)/0 to 3000 (°F)	-20 to 1720 (°C)/-40 to 3040 (°F)	
	B	18	100 to 1800 (°C)/300 to 3200 (°F)	0 to 1820 (°C)/0 to 3240 (°F)	
		19	0 to 2300 (°C)/0 to 3200 (°F)	-20 to 2320 (°C)/-40 to 3240 (°F)	
	W	20	0 to 1300 (°C)/0 to 2300 (°F)	-20 to 1320 (°C)/-40 to 2340 (°F)	
		21	10 to 70°C	0 to 90 (°C)/0 to 190 (°F)	-20 to 130 (°C)/-40 to 270 (°F)
	ES1B Infrared Temperature Sensor	60 to 120°C	22	0 to 120 (°C)/0 to 240 (°F)	-20 to 160 (°C)/-40 to 320 (°F)
		115 to 165°C	23	0 to 165 (°C)/0 to 320 (°F)	-20 to 205 (°C)/-40 to 400 (°F)
140 to 260°C		24	0 to 260 (°C)/0 to 500 (°F)	-20 to 300 (°C)/-40 to 580 (°F)	
Current input	4 to 20 mA	25	Any of the following ranges, by scaling: -1999 to 9999 -199.9 to 999.9 -19.99 to 99.99 -1.999 to 9.999	-5% to 105% of setting range. The display shows -1999 to 9999 (numeric range with decimal point omitted).	
	0 to 20 mA	26			
	Voltage input	1 to 5 V			27
Voltage input	0 to 5 V	28			
	0 to 10 V	29			

- The default is 5.
- The applicable standards for each of the above input ranges are as follows:  
K, J, T, E, N, R, S, B: JIS C1602-1995, IEC 60584-1  
L: Fe-CuNi, DIN 43710-1985  
U: Cu-CuNi, DIN 43710-1985  
W: W5Re/W26Re, ASTM E988-1990  
JPt100: JIS C 1604-1989, JIS C 1606-1989  
Pt100: JIS C 1604-1997, IEC 60751  
PLII: According to Platinel II Electromotive Force Table by Engelhard Corp.

# A-8 Setting Levels Diagram

This diagram shows all of the setting levels. To move to the Advanced Function Setting Level and Calibration Level, you must enter passwords. Some parameters are not displayed depending on the protect level setting and the conditions of use.

Control stops when you move from the Operation Level to the Initial Setting Level.

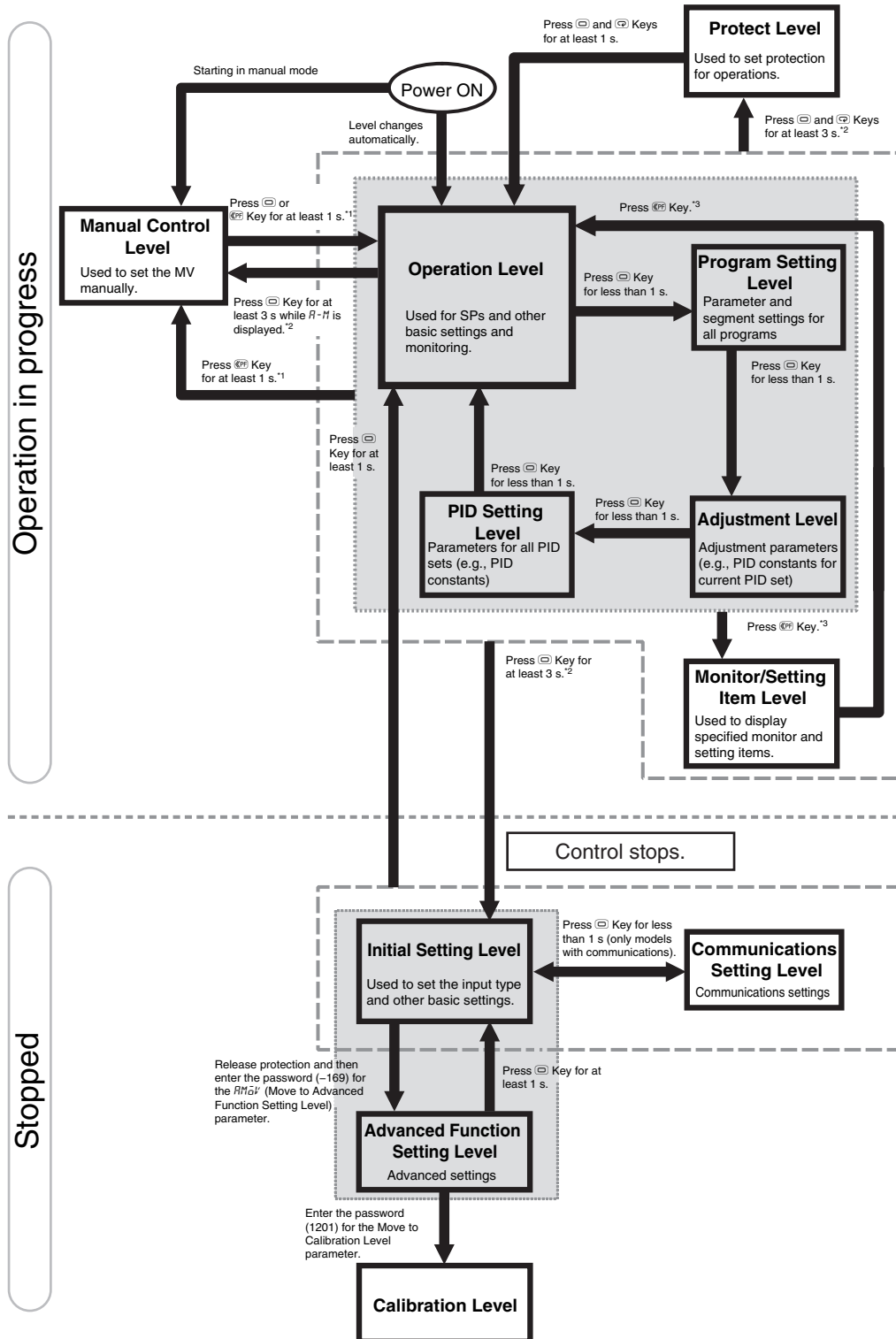

\*1 Set the PF Setting parameter to  $R-M$  (Auto/Manual).  
 \*2 The No. 1 display will flash when the keys are pressed for 1 s or longer.  
 \*3 Set the PF Setting parameter to  $PFdP$  (monitor/setting items).

# A-9 Parameter Flow

Some parameters may not be displayed depending on the model and other settings.

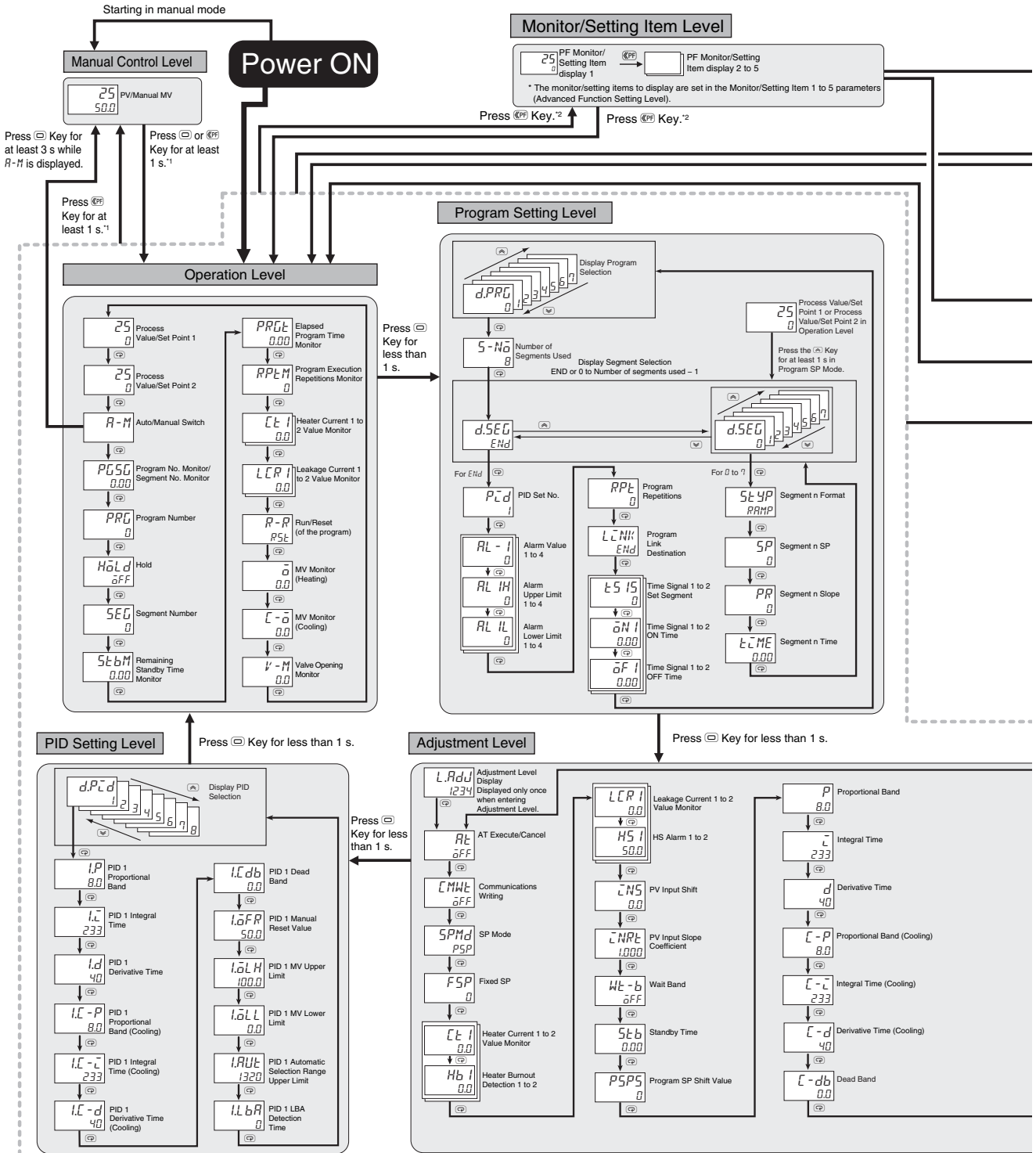

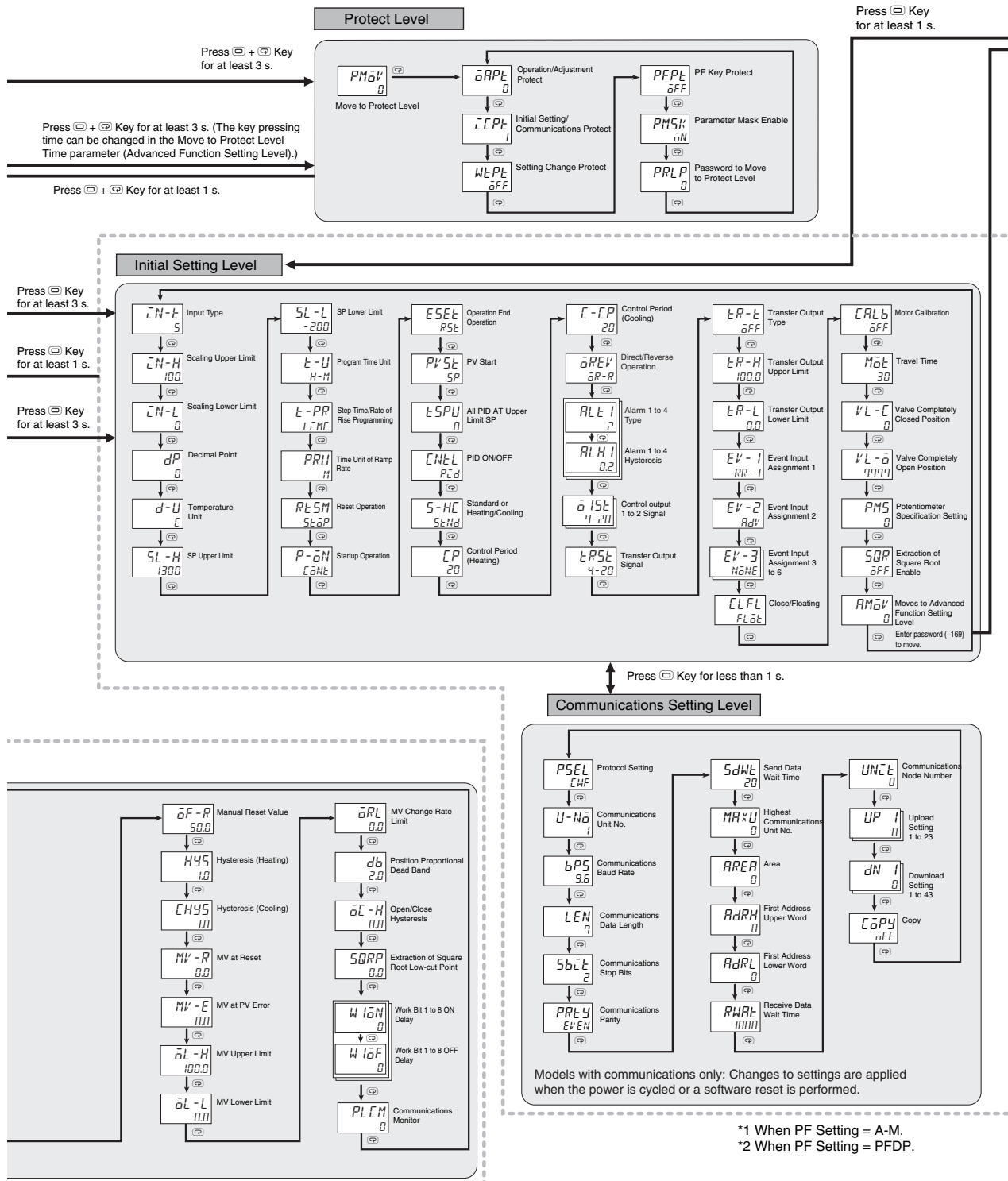

Advanced Function Setting Level

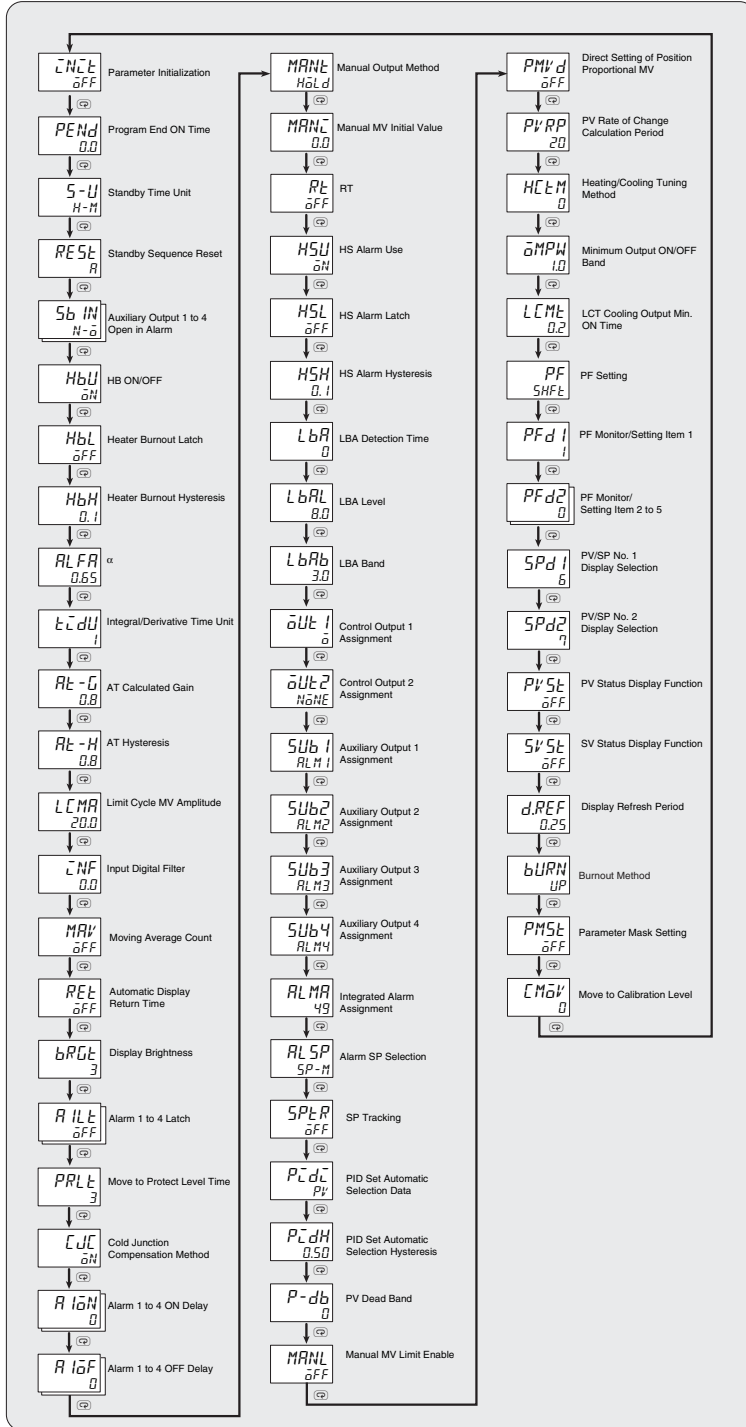





# Index



## Numerics

---

2-PID control ..... 4-21, 6-63

## A

---

AD Converter Error ..... A-12  
Adjustment Level ..... 6-24, A-20  
Advanced Function Setting Level ..... 6-80, A-27  
air cooling/water cooling tuning ..... 5-9  
alarm delays ..... 5-25  
alarm hysteresis ..... 4-62  
alarm latches ..... 4-63  
alarm operation ..... 4-63  
alarm outputs ..... 4-56  
alarm types ..... 4-56  
alarm values ..... 4-59  
alarms ..... 4-24  
alarms (standard alarms) ..... 1-4  
analog inputs ..... 5-5, 7-9  
assigning outputs ..... 4-23  
AT (auto-tuning) ..... 4-50  
auto/manual control ..... 5-12  
auto-tuning (AT) ..... 4-50, 6-27  
auxiliary output opening and closing in alarm ..... 4-26  
auxiliary outputs 1 to 4 ..... 2-18

## C

---

calibrating a current input ..... 7-9  
calibrating a voltage input ..... 7-10  
calibrating inputs ..... 7-2  
calibrating the transfer output ..... 7-11  
characteristics ..... A-4  
checking indication accuracy ..... 7-13  
    analog input ..... 7-15  
    infrared temperature sensor ..... 7-13  
    resistance thermometer ..... 7-14  
cold junction compensator ..... 7-13  
communications ..... 2-22  
communications operation command ..... 5-20  
Communications Setting Level ..... 6-111, A-32  
CompoWay/F ..... 6-112, A-32  
connecting the cold junction compensator ..... 7-4  
control outputs ..... 1-3, 4-25  
control outputs 1 and 2 ..... 2-17  
control periods ..... 4-22  
control ranges ..... A-36  
CT  
    dimensions ..... A-8  
        E54-CT1 ..... A-8  
        E54-CT3 ..... A-8  
    specifications ..... A-8  
CT inputs ..... 2-20  
current transformer (CT) ..... 4-68, A-8  
Current Value Exceeds ..... A-13  
CX-Thermo ..... 5-91

## D

---

derivative time ..... 4-55  
detection current values ..... 4-70  
Digit Shift Key ..... 3-8  
dimensions ..... 2-2  
direct and reverse operation ..... 4-22  
Display Range Exceeded ..... A-12  
Down Key (☑ Key) ..... 3-7

## E

---

error displays ..... A-11  
event inputs ..... 1-4, 2-19, 5-11  
extraction of square roots ..... 5-70

## F

---

front panel ..... 3-4  
    E5AC-T ..... 3-5  
    E5CC-T ..... 3-4  
    E5EC-T ..... 3-4

## H

---

HB alarm ..... 4-64, A-3, A-13  
heater burnout alarm ..... 6-84, A-3  
heater short alarm ..... 4-64, A-3  
heating/cooling control ..... 5-7, 6-64  
HS alarm ..... 4-66, A-3, A-13  
HS alarms ..... 1-4

## I

---

I/O configuration ..... 1-5  
indication ranges ..... A-36  
infrared temperature sensor ..... 7-13  
Initial Setting Level ..... 3-4, 6-54, A-23  
initialization ..... 6-82  
Input Error ..... A-11  
input error ..... 6-39  
input sensor types ..... 1-3  
input type ..... 4-18  
inputs ..... 2-16  
installation ..... 2-2  
    mounting the Terminal Covers  
        E5AC-T ..... 2-6  
        E5CC-T ..... 2-5  
        E5EC-T ..... 2-6  
    mounting to the panel  
        E5CC-T ..... 2-5  
        E5EC-T ..... 2-6  
insulation block diagrams ..... 2-23  
integral time ..... 4-55  
integral/derivative time unit ..... 5-9

## K

### Keys

Down Key	3-7
Level Key	3-6
Mode Key	3-7
Shift Key (PF Key)	3-7
Up Key	3-7

## L

Level Key (Key)	3-6
linear tuning	5-9
logic operations	5-82
loop burnout alarm	5-27

## M

main functions	1-3
manual control	5-31
Manual Control Level	6-52, A-26
manual setup	4-54
Memory Error	A-13
Modbus-RTU	A-32
Mode Key (Key)	3-7
model number legends	1-7
Monitor/Setting Item Level	6-50, A-26
mounting the Terminal Covers	
E5CC-T	2-5
E5EC-T	2-6

## N

No. 1 display	3-4, 4-76, 6-8
No. 2 display	3-4, 4-76, 6-8
No. 3 display	3-4, 4-76, 6-8

## O

ON/OFF control	4-21, 4-74, 6-63
operation indicators	3-4, 3-6
Operation Level	6-7, A-18
output limits	5-67
output periods	6-65

## P

panel cutout	2-3
parameter flow	A-38
parameter operation lists	A-18
parameter structure	7-3
parameters	
$\alpha$	6-86
Adjustment Level Display	6-26, 6-31, 6-32, 6-33, 6-35, 6-37, 6-38, 6-47, 6-49, 6-63, 6-64, 6-65, 6-76, 6-77, 6-78
Alarm 1 to 4 Hysteresis	6-70
Alarm 1 to 4 Latch	6-89

Alarm 1 To 4 OFF Delay	6-92
Alarm 1 to 4 ON Delay	6-91
Alarm 1 to 4 Type	4-56, 6-66
Alarm 1 to 4 Upper Limit	4-59
Alarm Lower Limit Value	4-59
Alarm SP Selection	6-99
Alarm Upper Limit Value	4-59
Alarm Value 1 to 4	4-59
Alpha	6-86
AT Calculated Gain	6-87
AT Calculation Gain	4-51
AT Execute/Cancel	6-27
AT Hysteresis	4-51, 6-87
Auto/Manual Switch	6-9
Automatic Display Return Time	6-88
Auxiliary Output 1 to 4 Assignment	4-23, 5-7, 6-98
Auxiliary Output 1 to 4 Open in Alarm	6-84
Cold Junction Compensation Method	6-90
Communications Baud Rate	6-111
Communications Data Length	6-111
Communications Parity	6-111
Communications Stop Bits	6-111
Communications Unit No.	6-111
Communications Wait Time	6-111
Communications Writing	6-28
Control Output 1 Assignment	6-97
Control Output 1 Signal	6-71
Control Output 2 Assignment	6-97
Control Output 2 Signal	6-71
Control Period (Cooling)	6-65
Control Period (Heating)	6-65
Dead Band	5-8, 6-37
Decimal Point	6-57
Derivative Time	6-36
Derivative Time (Cooling)	4-21, 5-9, 6-37
Direct Setting of Position Proportional MV	5-31, 6-102
Direct/Reverse Operation	6-66
Display Brightness	6-88
Display Refresh Period	6-109
Event Input Assignment	5-11
Event Input Assignment 1 to 6	6-74
event inputs	5-11
Extraction of Square Root Enable	5-70, 6-78
Extraction of Square Root Low-cut Point	5-70, 6-42
HB ON/OFF	6-84
Heater Burnout Detection 1	6-30
Heater Burnout Detection 2	6-31
Heater Burnout Hysteresis	6-85
Heater Burnout Latch	6-85
Heater Current 1 Value Monitor	6-12, 6-29
Heater Current 2 Value Monitor	6-13, 6-30
Heating/Cooling Tuning Method	5-9, 6-103
HS Alarm 1	6-32
HS Alarm 2	6-33
HS Alarm Hysteresis	6-95
HS Alarm Latch	6-94
HS Alarm Use	4-67, 6-94
Hysteresis	4-74
Hysteresis (Cooling)	6-38

Hysteresis (Heating) .....	6-38
Initial Setting/Communications Protect .....	6-4
Input Digital Filter .....	6-87
Input Type .....	6-56, A-23
input type .....	4-18
Integral Time .....	6-36
Integral Time (Cooling) .....	4-21, 5-9, 6-37
Integral/Derivative Time Unit .....	6-37, 6-86
Integrated Alarm Assignment .....	5-23, 6-99
LBA Band .....	5-28, 6-96
LBA Detection Time .....	5-28, 6-95
LBA Level .....	5-28, 6-96
LCT Cooling Output Minimum ON Time .....	6-104
Leakage Current 1 Monitor .....	6-13, 6-31, 6-47, 6-49, 6-63, 6-64, 6-65, 6-76, 6-77, 6-78
Leakage Current 2 Monitor .....	6-14, 6-32
Limit Cycle MV Amplitude .....	4-51, 6-87
Loop Burnout Alarm (LBA) .....	5-27
Manual Control Level .....	5-33
Manual MV Initial Value .....	6-93
Manual MV Limit Enable .....	6-101
Manual Output Method .....	6-92
Manual Reset Value .....	6-38
Minimum Output ON/OFF Band .....	6-104
Monitor/Setting Item 1 to 5 .....	6-106
Monitor/Setting Item Display 1 to 5 .....	6-51
Move to Advanced Function Setting Level .....	6-79
Move to Calibration Level .....	6-110
Move to Protect Level .....	6-3
Move to Protect Level Time .....	6-90
Move to the Protect Level .....	5-19
Moving Average Count .....	5-3, 6-88
MV (Manual MV) .....	6-53
MV at Error .....	6-39
MV at PV Error .....	5-68
MV at Reset .....	5-67
MV Change Rate Limit .....	5-72, 6-41
MV Lower Limit .....	6-40
MV Monitor (Cooling) .....	6-15
MV Monitor (Heating) .....	6-14
MV Upper Limit .....	6-40
Operation/Adjustment Protect .....	6-4
Parameter Initialization .....	6-82
Parameter Mask Enable .....	6-5
password .....	5-19
Password to Move to Protect Level .....	6-6, 6-13, 6-14, 6-15
PF Setting .....	6-51, 6-105
PID * LBA detection time .....	6-49
PID * MV lower limit .....	6-48
PID automatic selection range upper limit .....	6-49
PID MV upper limit .....	6-48
PID ON/OFF .....	6-63
PID ON/OFF parameter .....	4-75
Position Proportional Dead Band .....	5-80, 6-41
Process Value Input Shift .....	5-3
Process Value Slope Coefficient .....	5-3
Process Value/Set Point 1 .....	6-8
Process Value/Set Point 2 .....	6-8
Proportional Band .....	6-36
Proportional Band (Cooling) .....	4-21, 5-9, 6-37
Protocol Setting .....	6-111
PV Rate of Change Calculation Period .....	4-60, 6-102
PV Status Display Function .....	6-108
PV/MV (Manual MV) .....	6-53
PV/SP Display Selection .....	6-8
PV/SP No. 1 Display Selection .....	4-76, 6-8, 6-107
PV/SP No. 2 Display Selection .....	4-76, 6-8, 6-107
RT .....	6-94, 6-95, 6-96
RT (Robust Tuning) .....	6-93
Scaling Lower Limit .....	6-57
Scaling Upper Limit .....	6-57
Set Point Lower Limit .....	5-16
Set Point Upper Limit .....	5-16
Setting Change Protect .....	6-5
SP Lower Limit .....	6-58
SP Mode .....	6-28
SP Tracking .....	6-100
SP Upper Limit .....	6-58
Standard or Heating/Cooling .....	6-64
Standby Sequence Reset .....	6-83
SV Status Display Function .....	6-109
Temperature Unit .....	6-57
Transfer Output Lower Limit .....	6-73
Transfer Output Signal .....	6-71
Transfer Output Type .....	5-34, 6-72
Transfer Output Upper Limit .....	6-73
Work Bit 1 to 8 OFF Delay .....	6-43
Work Bit 1 to 8 ON Delay .....	6-43
password .....	5-19, 5-20
setting .....	5-20
PF Key (PF Key) .....	3-7, 3-8, 5-19, 5-33, 5-74, 6-5
PF setting .....	5-74
PID constants .....	4-49
PID control .....	4-21
position-proportional control .....	5-79
Potentiometer Input .....	2-21
potentiometer input error .....	5-31, 5-68
potentiometer input error (Position-proportional Models Only) .....	A-14
power supply .....	2-16
process value/set point 1 .....	4-76
process value/set point 2 .....	4-76
proportional action .....	4-54
proportional band .....	4-55
Protect Level .....	6-3, A-31
protection .....	5-18
Initial Setting/Communications Protect .....	5-19
Operation/Adjustment Protect .....	5-18
PF Key Protect .....	5-19
Setting Change Protect .....	5-19
PV change rate alarm .....	4-60
PV status display .....	5-77
<b>R</b>	
ratings .....	A-2
registering calibration data .....	7-2
resistance thermometer calibration .....	7-7

RS-485 .....	2-22
run/stop control .....	5-12

## S

---

sampling cycle .....	1-2, 4-60
sensor input setting ranges .....	A-36
set point limiter .....	5-16
setting levels diagram .....	A-37
setting monitor/setting items .....	5-76
setting output specifications .....	4-22
setting the input type .....	4-18
setting the SP upper and lower limit values .....	5-16
Setup Tool ports .....	2-24, 2-25, 3-8
Shift Key (⌘ Key) .....	3-8
shifting input values .....	5-3
shifting inputs .....	5-3
specifications .....	A-2
standard control .....	6-64
standby sequences .....	4-62
SV status display .....	5-77
switching the SP mode .....	5-13

## T

---

temperature unit .....	4-20
terminal arrangement .....	2-7
terminal block wiring examples	
E5AC-T .....	2-11
E5CC-T .....	2-7
E5EC-T .....	2-11
thermocouple calibration .....	7-4
thermocouple or infrared temperature sensor .....	7-13
three-position control .....	5-10
transfer output .....	2-21, 5-34
transfer output signal .....	5-34
transfer scaling .....	5-35
troubleshooting .....	A-15

## U

---

Up Key (⬆ Key) .....	3-7
USB-Serial Conversion Cable .....	2-24, 2-26, A-9
user calibration .....	7-2
using the terminals .....	2-7

## V

---

versions .....	1-12
----------------	------

## W

---

wiring .....	2-16
wiring precautions .....	2-16
work bit 1 to 8 .....	5-85





**OMRON Corporation Industrial Automation Company**

Tokyo, JAPAN

Contact: [www.ia.omron.com](http://www.ia.omron.com)

**Regional Headquarters**

**OMRON EUROPE B.V.**

Wegalaan 67-69-2132 JD Hoofddorp  
The Netherlands

Tel: (31)2356-81-300/Fax: (31)2356-81-388

**OMRON ELECTRONICS LLC**

One Commerce Drive Schaumburg,  
IL 60173-5302 U.S.A.

Tel: (1) 847-843-7900/Fax: (1) 847-843-7787

**OMRON ASIA PACIFIC PTE. LTD.**

No. 438A Alexandra Road # 05-05/08 (Lobby 2),  
Alexandra Technopark,  
Singapore 119967

Tel: (65) 6835-3011/Fax: (65) 6835-2711

**OMRON (CHINA) CO., LTD.**

Room 2211, Bank of China Tower,  
200 Yin Cheng Zhong Road,  
PuDong New Area, Shanghai, 200120, China

Tel: (86) 21-5037-2222/Fax: (86) 21-5037-2200

**Authorized Distributor:**

© OMRON Corporation 2014 All Rights Reserved.  
In the interest of product improvement,  
specifications are subject to change without notice.

**Cat. No. H185-E1-01**

0114