

# UHF RFID System

V780 Series

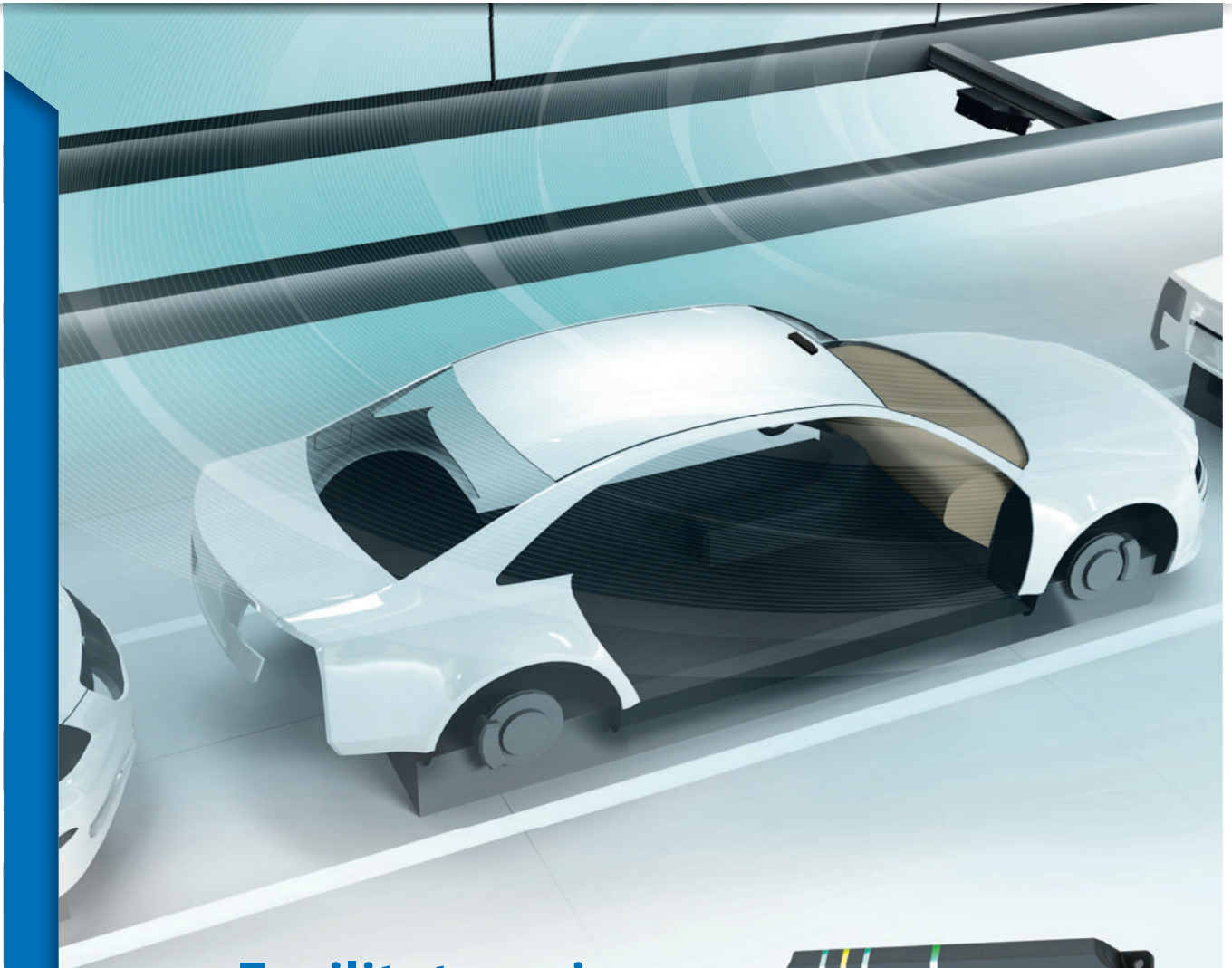

**Facilitate unique  
identification of  
large objects**



# Easy to use long range RFID for unique of large objects like car bodies



UHF RFID System  
**V780** Series

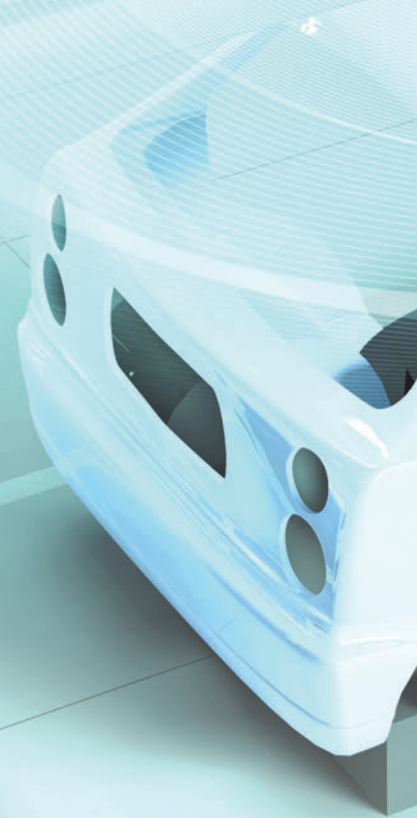

# identification

## Increasing high-mix/low-volume production and modular production lines

### Challenges when introducing RFID

### V780 Series

**Install into high-mix  
production lines**

**Reliable RF tag reading from several meters away**  
Can be used for a production line on which  
objects with various heights are conveyed

p.4

**Quickly install and tune**

**Automatic setting adjustment according  
to environment**  
Can be installed without RFID expertise

p.5

**Make troubleshooting easy**

**Visualizing causes from 8,000 logged results**  
Helps reduce troubleshooting time

p.6



## Stable communications even in high-mix production lines

# Reliable long distance communications

### Stable detection of objects with different heights

The UHF RFID system with a wide communication range can identify the objects in various sizes on a line or the carts which take different routes.

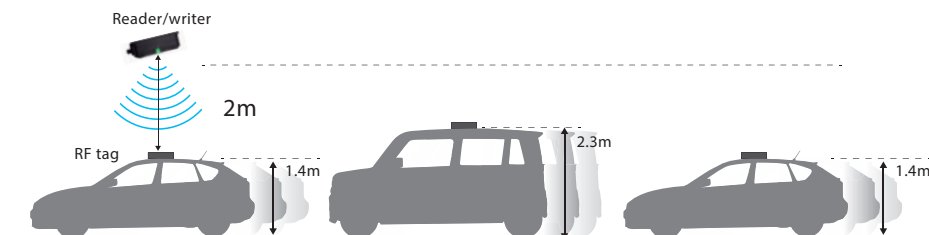

### Focus Mode prevents misreads and reads only target tags **PATENT PENDING**

Even when two or more RF tags exist in the communication range, the reader/writer can read the target tag just in front of it. It reads RF tags in the order in which they are conveyed while ignoring RF tags on pallets around the line.



### Multi-Reader/Writer function\* for high-mix production

This function enables up to eight reader/writers to communicate as if they are one reader/writer. When a wider communication range is required (e.g., checking all stacked pallets with an RF tag at the same time), multiple reader/writers can be installed one above the other to cover the required communication range. The host device sends commands only to the master reader/writer to communicate.

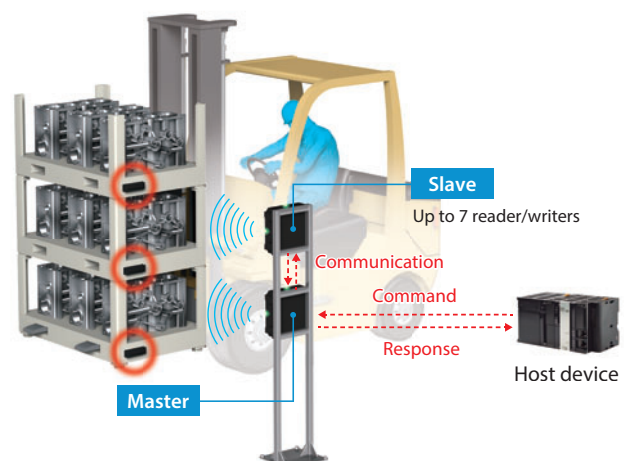

\*.Version 3 or later provides this function.

## No RFID expertise required for installation

# Automatic setting adjustment according to environment

### Automatic transmission power tuning

The transmission power required for communications between the reader/writer and RF tags are measured and automatically set to appropriate values. The set power will be large enough to communicate with RF tags and minimize interference with other reader/writers.

This function is useful when multiple reader/writers are installed in one factory. The transmission power can be easily set via the web browser.

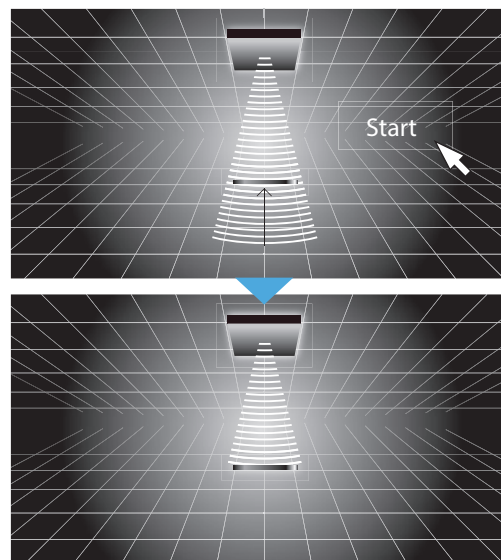

Power is tuned to the target RF tag, which reduces installation and adjustment time

### Reception Level Monitor shows reception levels over time for installation/adjustment

This function visualizes reception levels, helping adjust installation positions of reader/writers and RF tags and check communication ranges.

When RF tags on two or more objects are read for adjustment, connect your PC with the reader/writer to check a time series graph of the reception levels via the web browser.

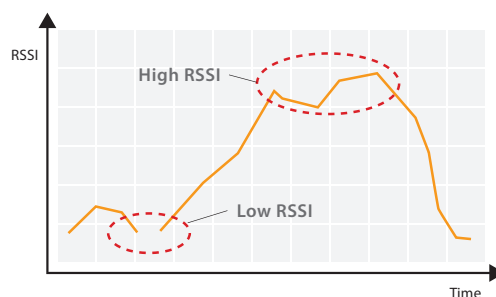

### LED indicators help you adjust installation positions

In addition to the web browser, the flashing speed of the LED indicators on the reader/writer provides a visual indication of the reception level. This makes it easier to install and adjust a reader/writer or RF tag at a production site.



Check the reception level with the indicators on the reader/writer to find the best installation position of an RF tag

## Easy troubleshooting during operation

# Visualizing causes from 8,000 logged results

### Monitor communication status via the web browser

By connecting a PC, you can set parameters and monitor communication status, noise levels, and communication log via the web browser. This facilitates maintenance and troubleshooting.

- **RF communications diagnostics log** (displayed as a list or graph)

The latest 8,000 communication diagnostic results are listed in a table. When communications are unstable, the probable causes and workarounds are displayed to make troubleshooting easier. Also, a graph shows RSSI levels and noise levels to aid identify the causes of unstable communications. The diagnostic results can be output to CSV files.

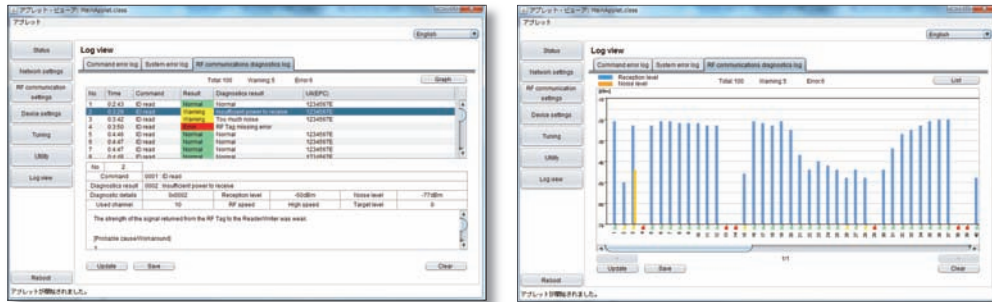

- **Channel monitor**

Noise levels in the operating environment are displayed to allow you to check radio interference. You can identify noise sources and take measures to stabilize operation.

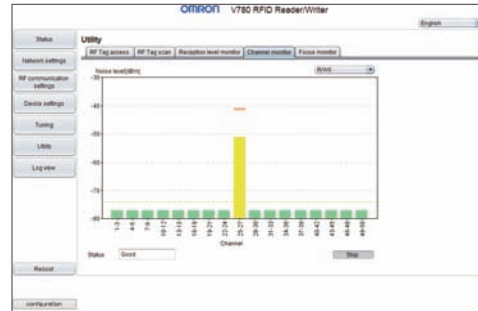

### Real-time communication status indication

You can immediately check the communication status with the indicators of the reader/writer. The indicators using high-brightness LED can be easily seen even from a distance.

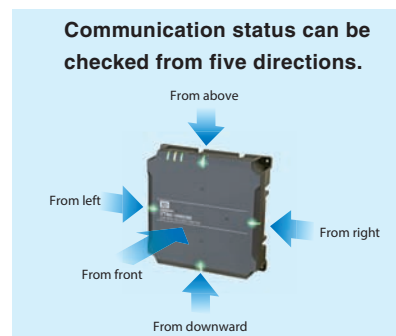

# Applications

## Automotive body assembly

**Introduce unique identification of bodies to high-mix production lines**

The wide communication range and focus mode enable bodyworks to be reliably detected from several meters away.

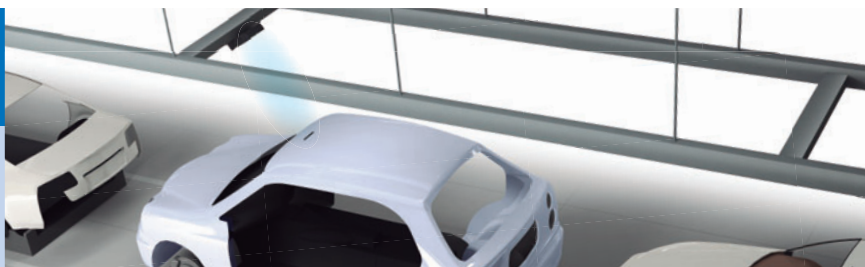

## Parts transportation

**Accurately supply parts even in high-mix production**

The passing pallets can be detected correctly. The LED indicators show in real time whether the pallet is detected.

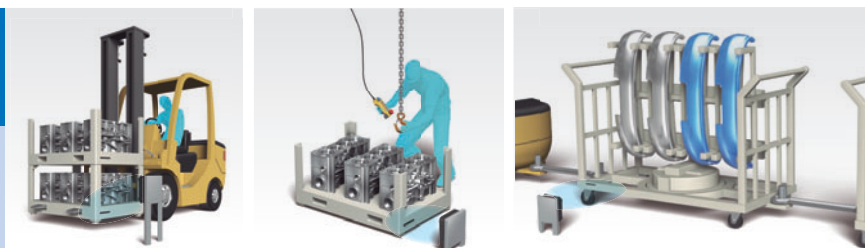

## Handling materials in containers

**Quickly set up detection of individual containers**

Reception Level Monitor that shows reception levels over time helps installation. No special knowledge required.

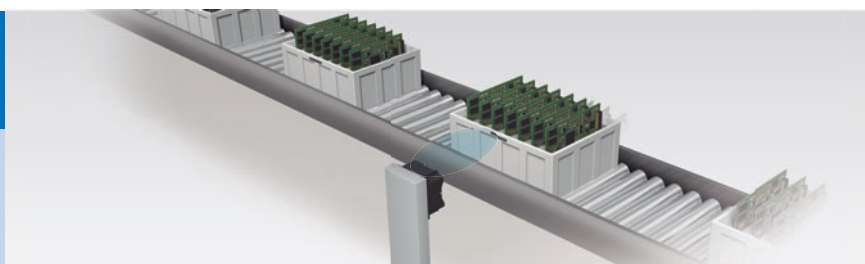

## Hanging conveyance

**Introduce unique identification for high-mix production**  
**Facilitate maintenance work at heights**

High-brightness LED indicators that provide clear status indication can be seen from a distance.

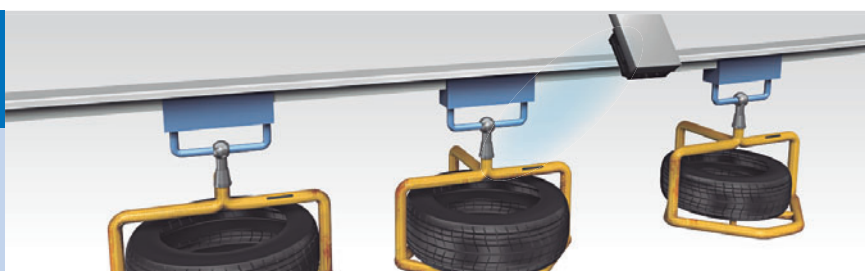

## Paper roll management

**Introduce unique identification for high-mix production**  
**Reduce effects of noise from other devices**

The causes are visualized from 8,000 logged results. Channel monitor shows noise levels in the web browser to help identify the causes.

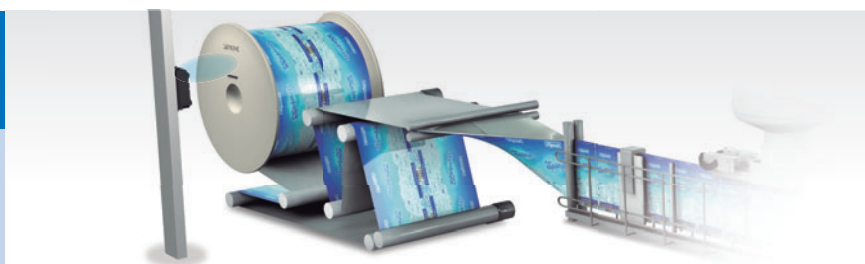

**Regulations for UHF wireless  
(radio regulations)  
will be complied with**

RFID systems as well as mobile phones and TVs must comply with national radio regulations. The V780 Series currently complies with radio regulations in many countries and will comply with them in other countries. For the list of countries where the V780 is available, please contact your Omron representative or visit our website: <http://www.ia.omron.com/>.

# System configurations

## When connecting one reader/writer to host device

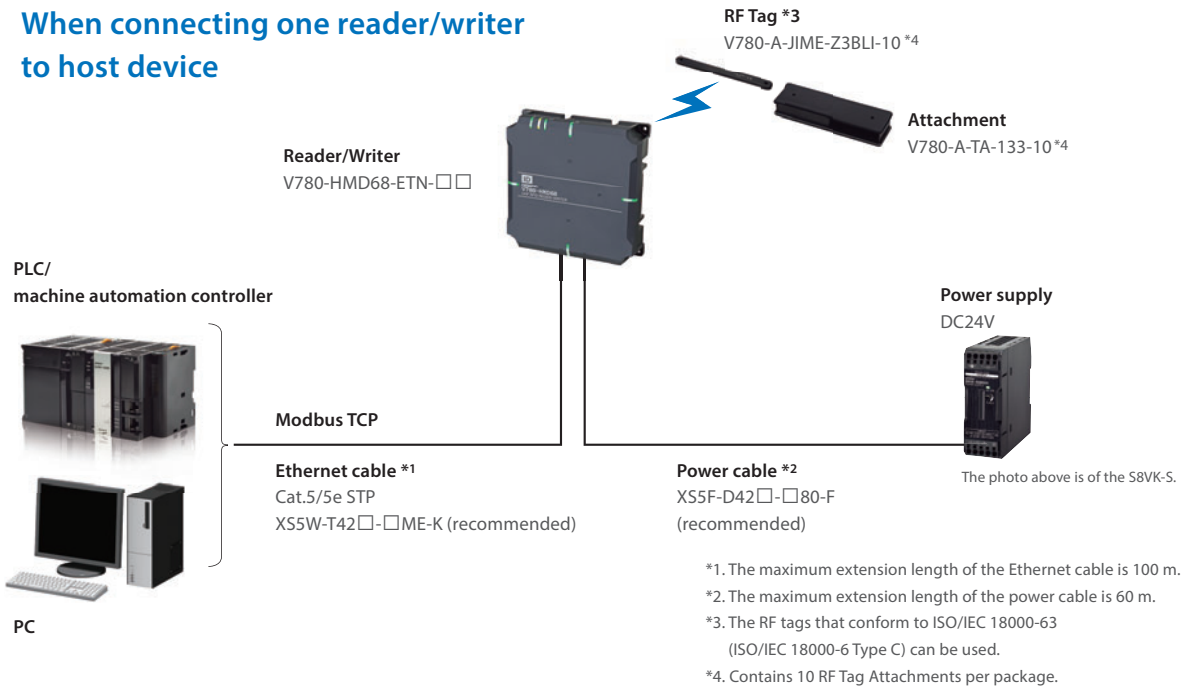

## When connecting two or more reader/writers to host device

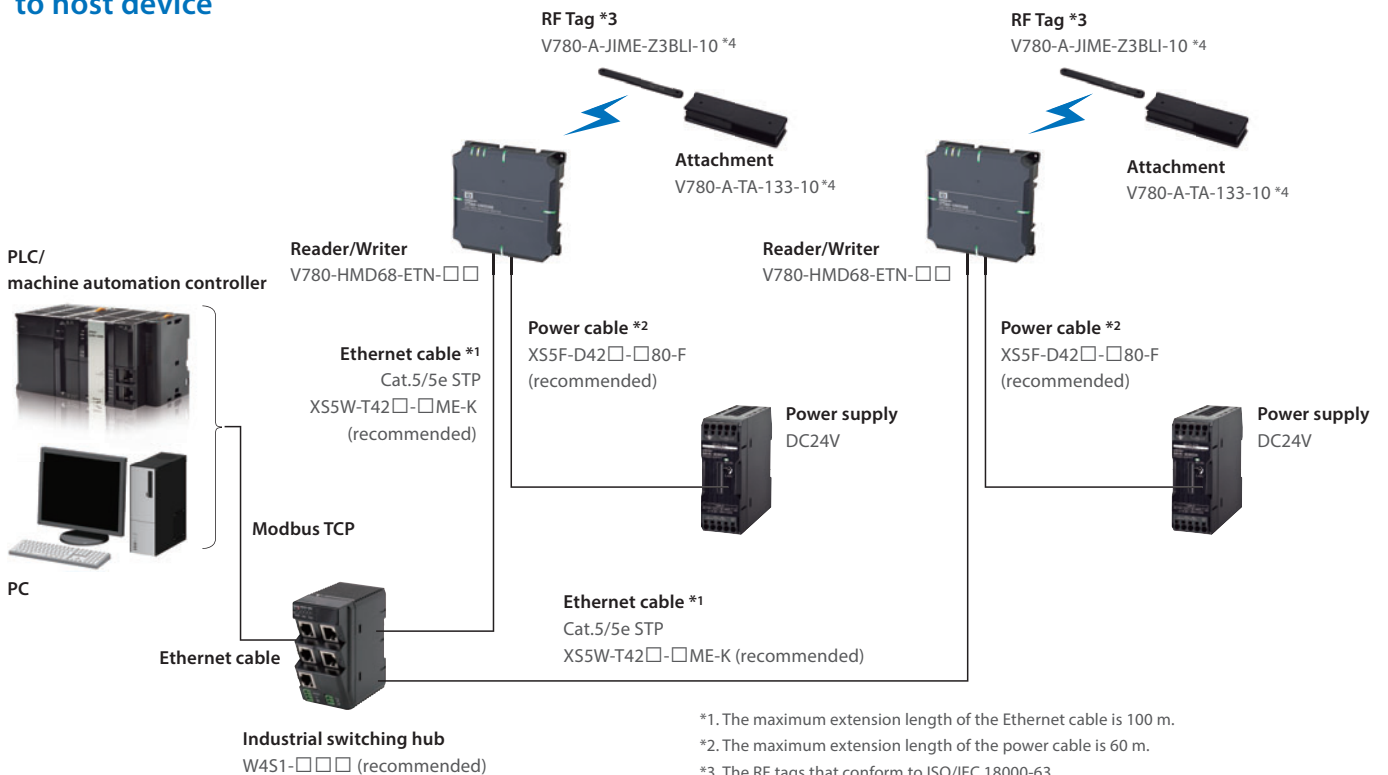

Note. The maximum number of reader/writers that can be connected to the Ethernet port depends on the host device. Contact your Omron representative for details.



# UHF RFID System

# V780 Series

## 3 in 1 UHF RFID System: Antenna, Amplifier & Controller

- Conforms to ISO/IEC 18000-63: 2013
- Long range and stable communications
- Reader/writer with integrated antenna
- Communications status visualized by LED indicators
- Host communications: Ethernet (Modbus/TCP base)
- Simple and easy to use



 Refer to the *Safety Precautions and Precautions for Correct Use* in the User's Manual.

## Ordering Information

### Reader/Writer

Appearance	Size (mm)	Network	Applicable countries *	Model
	250 × 250 × 70	Modbus/TCP base (TCP/IP)	Japan	V780-HMD68-ETN-JP
			Korea	V780-HMD68-ETN-KR
			China	V780-HMD68-ETN-CN
			Taiwan	V780-HMD68-ETN-TW
			India	V780-HMD68-ETN-IN
			Indonesia	V780-HMD68-ETN-ID
			Malaysia	V780-HMD68-ETN-MY
			Singapore and Thailand	V780-HMD68-ETN-SG
			Under RE direct.	V780-HMD68-ETN-EU
			Russia	V780-HMD68-ETN-RU
			United States and Canada	V780-HMD68-ETN-US
			Mexico	V780-HMD68-ETN-MX

\* Contact your Omron representative for details on products for other countries.

### RF Tag

Appearance	Memory capacity	Size (mm)	Model
	1 KB	150 × 14 × 6	V780-A-JIME-Z3BLI-10 *

\* Contains 10 RF Tags per package.

### RF Tag Attachment

Appearance	Material	Size (mm)	Model
	Polycarbonate plastic	180 × 50 × 30	V780-A-TA-133-10 *

\* Contains 10 RF Tag Attachments per package.

**Note:** 1. Use the RF Tag Attachment when mounting on metal surface. Refer to the User's Manual for how to mount.

2. Toppan Forms Co., Ltd. manufactures RF Tags and Attachments. For more information, visit the following website:  
<http://www.toppan-f.co.jp/english/>

# V780 Series

## Cables

### Recommended Ethernet Cables (Connection between Host Device and Reader/Writer)

Use STP (shielded twisted-pair) cable of category 5 or higher.

Specifications		Cable length (m) *	Model
Wire Gauge and Number of Pairs: AWG22, 2-pair Cable	Cable with Plug on One End and Socket on Other End (M12 Straight/RJ45)	0.5	XS5W-T421-BME-K
		1	XS5W-T421-CME-K
		2	XS5W-T421-DME-K
		5	XS5W-T421-GME-K
		10	XS5W-T421-JME-K

\* 3- and 15-m cables are also available.

**Note:** For details, refer to the *Industrial Ethernet Connectors Catalog* (Cat. No. G019).

Other cable lengths, robot cables, and extension cables are available. Contact your Omron representative for details.

### Recommended Power Cables (Connection between Power Supply and Reader/Writer)



XS5F-D42□-□80-F

Specifications	Cable length (m)	Cable outer diameter (mm)	Straight Connectors	Angled Connectors
			Model	Model
Fire-retardant, Robot Cable	1	6	XS5F-D421-C80-F	XS5F-D422-C80-F
	2		XS5F-D421-D80-F	XS5F-D422-D80-F
	3		XS5F-D421-E80-F	XS5F-D422-E80-F
	5		XS5F-D421-G80-F	XS5F-D422-G80-F
	10		XS5F-D421-J80-F	XS5F-D422-J80-F

**Note:** For details, refer to the XS5 datasheet (<http://www.ia.omron.com/>).

Other cable lengths and extension cables are available. Contact your Omron representative for details.

## Recommended Industrial Switching Hubs

Appearance	Specifications			Model
	Functions	No. of ports	Failure detection	
	Quality of Service (QoS): EtherNet/IP control data priority Failure detection:	3	No	W4S1-03B
	Broadcast storm and LSI error detection 10/100BASE-TX, Auto-Negotiation	5	No	W4S1-05B
		5	Yes	W4S1-05C

## Ratings and Performance

### Reader/Writer

#### General Specifications

Item	V780-HMD68-ETN-□□
Dimensions	250 × 250 × 70 mm (D × H × W, excluding protruding parts and cables)
Supply voltage	24 VDC (−15% to +10%)
Power consumption	10 W max.
Ambient operating temperature	−10 to 55°C (with no icing)
Ambient operating humidity	25% to 85% (with no condensation)
Ambient storage temperature	−25 to 70°C (with no icing)
Ambient storage humidity	25% to 85% (with no condensation)
Insulation resistance	20 MΩ min. (at 500 VDC) between cable terminals and case
Dielectric strength	1,000 VAC, 50/60 Hz for 1 min between cable terminals and case
Vibration resistance	No abnormality after application of 10 to 500 Hz, double amplitude: 1.5 mm, acceleration: 100 m/s <sup>2</sup> , 10 sweeps in each of 3 axis directions (up/down, left/right, and forward/backward) for 11 minutes each
Shock resistance	No abnormality after application of 500 m/s <sup>2</sup> , 3 times each in 6 directions (Total: 18 times)
Degree of protection	IP54 (IEC 60529:2001)
Materials	Plastic case: PBT Metal case: Die-cast aluminum (ADC12)
Weight	Approx. 3 kg
Mounting method	Four M6 bolts
Host communications interface	Ethernet 10BASE-T/100BASE-TX
Host communications protocol	Modbus/TCP base
Accessories	Instruction Sheet (1), IP address label (1), Startup Guide (1), Ferrite core (2) *1, and EU DECLARATION OF CONFORMITY (1) *2
Regulations	See <i>Regulations</i> on page 11 for the regulations.

\*1. A ferrite core is packaged with Model V780-HMD68-ETN-EU-IN.

\*2. A EU DECLARATION OF CONFORMITY is packaged with Model V780-HMD68-ETN-EU.

## Regulations

Model	Regulations
V780-HMD68-ETN-JP	Premises Radio Station (920-MHz-band Moving Object Differentiation Wireless Facilities), ARIB STD-T106
V780-HMD68-ETN-KR	무선설비규칙
V780-HMD68-ETN-CN	Ministry of Information Industry No. 205 (2007)
V780-HMD68-ETN-TW	NCC LP0002 4.8 RFID
V780-HMD68-ETN-IN	the G.S.R.36 (E)
V780-HMD68-ETN-ID	PERDIRJEN POSTEL Nomor: 221/DIRJEN/2007
V780-HMD68-ETN-MY	MCMC MTSFB TC T007:2014
V780-HMD68-ETN-SG	Singapore: IMDA TS SRD2 Thailand: NTC TS 1010-2550 (RFID 920-925 MHz)
V780-HMD68-ETN-EU	2014/53EU (RE Directive)
V780-HMD68-ETN-RU	к решению ГКПЧ от 07.05.2007 № 07-20-03-001
V780-HMD68-ETN-US	FCC 15.247 (United states) ISED RSS-247 (Canada)
V780-HMD68-ETN-MX	IFT-008 NYCE NOM-208

## Tag Communications Specifications

## V780-HMD68-ETN-JP

Item	V780-HMD68-ETN-JP
Applicable countries	Japan
Maximum Radiated Power	4 W e.i.r.p
Output power	15 to 27 dBm (Switchable in 1-dB increments.)
RSSI detection range	Signal level: -35 to -61 dBm Noise level: -35 to -70 dBm (at end of antenna cable)
Transmission speed from Reader/Writer to RF Tag	40 kbps (fixed)
Transmission speed from RF Tag to Reader/Writer	<ul style="list-style-type: none"> <li>• 80 kbps (High-speed Mode) *</li> <li>• 20 kbps (Standard Mode) *</li> </ul>
Used frequencies (Described at the center frequency of each channel)	3 channels (916.8/918.0/919.2 MHz) License station
Channel interval	200 kHz
Communications method with RF Tags	Miller-modulated subcarrier
Tag communications protocol	ISO/IEC 18000-63: 2013 (EPCglobal Class-1 Generation-2)
Polarization characteristic	RHCP
Multiaccess communications	Up to 64 RF Tags can be read.

\* The default setting is for Automatic Mode. The Reader/Writer will automatically change to High-speed Mode or Standard Mode depending on the interference waves.

## V780-HMD68-ETN-KR

Item	V780-HMD68-ETN-KR
Applicable countries	Korea
Maximum Radiated Power	4 W e.i.r.p
Output power	15 to 27 dBm (Switchable in 1-dB increments.)
RSSI detection range	Signal level: -35 to -61 dBm Noise level: -35 to -70 dBm (at end of antenna cable)
Transmission speed from Reader/Writer to RF Tag	40 kbps (fixed)
Transmission speed from RF Tag to Reader/Writer	<ul style="list-style-type: none"> <li>• 80 kbps (High-speed Mode) *</li> <li>• 31.25 kbps (Standard Mode) *</li> </ul>
Used frequencies	6 channels (917.3/917.9/918.5/919.1/919.7/920.3 MHz) FHSS
Channel interval	200 kHz
Communications method with RF Tags	Miller-modulated subcarrier
Tag communications protocol	ISO/IEC 18000-63: 2013 (EPCglobal Class-1 Generation-2)
Polarization characteristic	RHCP
Multiaccess communications	Up to 64 RF Tags can be read.

\* The default setting is for Automatic Mode. The Reader/Writer will automatically change to High-speed Mode or Standard Mode depending on the interference waves.

# V780 Series

## V780-HMD68-ETN-CN

	Item	V780-HMD68-ETN-CN
Tag Communications Specifications	Applicable countries	China
	Maximum Radiated power	2 W e.r.p
	Output power	15 to 27 dBm (Switchable in 1-dB increments.)
	RSSI detection range	Signal level: -35 to -61 dBm Noise level: -35 to -70 dBm (at end of antenna cable)
	Transmission speed from Reader/Writer to RF Tag	40 kbps (fixed)
	Transmission speed from RF Tag to Reader/Writer	<ul style="list-style-type: none"> <li>• 80 kbps (High-speed Mode) *</li> <li>• 20 kbps (Standard Mode) *</li> </ul>
	Used frequencies	16 channels (920.625 to 924.375 MHz) FHSS
	Channel interval	250 kHz
	Communications method with RF Tags	Miller-modulated subcarrier
	Tag communications protocol	ISO/IEC 18000-63: 2013 (EPCglobal Class-1 Generation-2)
	Polarization characteristic	RHCP
Multiaccess communications	Up to 64 RF Tags can be read.	

\* The default setting is for Automatic Mode. The Reader/Writer will automatically change to High-speed Mode or Standard Mode depending on the interference waves.

## V780-HMD68-ETN-TW

	Item	V780-HMD68-ETN-TW
Tag Communications Specifications	Applicable countries	Taiwan
	Maximum Radiated power	4 W e.i.r.p (indoor use only)
	Output power	15 to 27 dBm (Switchable in 1-dB increments.)
	RSSI detection range	Signal level: -35 to -61 dBm Noise level: -35 to -70 dBm (at end of antenna cable)
	Transmission speed from Reader/Writer to RF Tag	40 kbps (fixed)
	Transmission speed from RF Tag to Reader/Writer	<ul style="list-style-type: none"> <li>• 80 kbps (High-speed Mode) *</li> <li>• 31.25 kbps (Standard Mode) *</li> </ul>
	Used frequencies	10 channels (922.75 to 927.25 MHz) FHSS
	Channel interval	500 kHz
	Communications method with RF Tags	Miller-modulated subcarrier
	Tag communications protocol	ISO/IEC 18000-63: 2013 (EPCglobal Class-1 Generation-2)
	Polarization characteristic	RHCP
Multiaccess communications	Up to 64 RF Tags can be read.	

\* The default setting is for Automatic Mode. The Reader/Writer will automatically change to High-speed Mode or Standard Mode depending on the interference waves.

## V780-HMD68-ETN-IN

	Item	V780-HMD68-ETN-IN
Tag Communications Specifications	Applicable countries	India
	Maximum Radiated Power	2 W e.r.p
	Output power	15 to 27 dBm (Switchable in 1-dB increments.)
	RSSI detection range	Signal level: -35 to -61 dBm Noise level: -35 to -70 dBm (at end of antenna cable)
	Transmission speed from Reader/Writer to RF Tag	40 kbps (fixed)
	Transmission speed from RF Tag to Reader/Writer	<ul style="list-style-type: none"> <li>• 80 kbps (High-speed Mode) *</li> <li>• 31.25 kbps (Standard Mode) *</li> </ul>
	Used frequencies	3 channels (865.7/866.3/866.9 MHz) FHSS
	Channel interval	200 kHz
	Communications method with RF Tags	Miller-modulated subcarrier
	Tag communications protocol	ISO/IEC 18000-63: 2013 (EPCglobal Class-1 Generation-2)
	Polarization characteristic	RHCP
Multiaccess communications	Up to 64 RF Tags can be read.	

\* The default setting is for Automatic Mode. The Reader/Writer will automatically change to High-speed Mode or Standard Mode depending on the interference waves.

## V780-HMD68-ETN-ID

Item		V780-HMD68-ETN-ID
Tag Communications Specifications	Applicable countries	Indonesia
	Maximum Radiated power	2 W e.r.p
	Output power	15 to 27 dBm (Switchable in 1-dB increments.)
	RSSI detection range	Signal level: -35 to -61 dBm Noise level: -35 to -70 dBm (at end of antenna cable)
	Transmission speed from Reader/Writer to RF Tag	40 kbps (fixed)
	Transmission speed from RF Tag to Reader/Writer	<ul style="list-style-type: none"> <li>• 80 kbps (High-speed Mode) *</li> <li>• 31.25 kbps (Standard Mode) *</li> </ul>
	Used frequencies	4 channels (923.25/923.75/924.25/924.75 MHz) FHSS
	Channel interval	500 kHz
	Communications method with RF Tags	Miller-modulated subcarrier
	Tag communications protocol	ISO/IEC 18000-63: 2013 (EPCglobal Class-1 Generation-2)
	Polarization characteristic	RHCP
	Multiaccess communications	Up to 64 RF Tags can be read.

\* The default setting is for Automatic Mode. The Reader/Writer will automatically change to High-speed Mode or Standard Mode depending on the interference waves.

## V780-HMD68-ETN-MY

Item		V780-HMD68-ETN-MY
Tag Communications Specifications	Applicable countries	Malaysia
	Maximum Radiated power	2 W e.r.p
	Output power	15 to 27 dBm (Switchable in 1-dB increments.)
	RSSI detection range	Signal level: -35 to -61 dBm Noise level: -35 to -70 dBm (at end of antenna cable)
	Transmission speed from Reader/Writer to RF Tag	40 kbps (fixed)
	Transmission speed from RF Tag to Reader/Writer	<ul style="list-style-type: none"> <li>• 80 kbps (High-speed Mode) *</li> <li>• 31.25 kbps (Standard Mode) *</li> </ul>
	Used frequencies	8 channels (919.25 to 922.75 MHz) FHSS
	Channel interval	500 kHz
	Communications method with RF Tags	Miller-modulated subcarrier
	Tag communications protocol	ISO/IEC 18000-63: 2013 (EPCglobal Class-1 Generation-2)
	Polarization characteristic	RHCP
	Multiaccess communications	Up to 64 RF Tags can be read.

\* The default setting is for Automatic Mode. The Reader/Writer will automatically change to High-speed Mode or Standard Mode depending on the interference waves.

## V780-HMD68-ETN-SG

Item		V780-HMD68-ETN-SG
Tag Communications Specifications	Applicable countries	Singapore and Thailand
	Maximum Radiated Power	2 W e.r.p
	Output power	15 to 27 dBm (Switchable in 1-dB increments.)
	RSSI detection range	Signal level: -35 to -61 dBm Noise level: -35 to -70 dBm (at end of antenna cable)
	Transmission speed from Reader/Writer to RF Tag	40 kbps (fixed)
	Transmission speed from RF Tag to Reader/Writer	<ul style="list-style-type: none"> <li>• 80 kbps (High-speed Mode) *</li> <li>• 31.25 kbps (Standard Mode) *</li> </ul>
	Used frequencies	8 channels (920.75 to 924.25 MHz) FHSS
	Channel interval	500 kHz
	Communications method with RF Tags	Miller-modulated subcarrier
	Tag communications protocol	ISO/IEC 18000-63: 2013 (EPCglobal Class-1 Generation-2)
	Polarization characteristic	RHCP
	Multiaccess communications	Up to 64 RF Tags can be read.

\* The default setting is for Automatic Mode. The Reader/Writer will automatically change to High-speed Mode or Standard Mode depending on the interference waves.

# V780 Series

## V780-HMD68-ETN-EU

	Item	V780-HMD68-ETN-EU
Tag Communications Specifications	Applicable countries	Under RE direct
	Maximum Radiated Power	2 W e.r.p
	Output power	15 to 27 dBm (Switchable in 1-dB increments.)
	RSSI detection range	Signal level: -35 to -61 dBm Noise level: -35 to -70 dBm (at end of antenna cable)
	Transmission speed from Reader/Writer to RF Tag	40 kbps (fixed)
	Transmission speed from RF Tag to Reader/Writer	<ul style="list-style-type: none"> <li>• 80 kbps (High-speed Mode) *</li> <li>• 31.25 kbps (Standard Mode) *</li> </ul>
	Used frequencies	4 channels (865.7/866.3/866.9/867.5 MHz) FHSS
	Channel interval	200 kHz
	Communications method with RF Tags	Miller-modulated subcarrier
	Tag communications protocol	ISO/IEC 18000-63: 2013 (EPCglobal Class-1 Generation-2)
	Polarization characteristic	RHCP
Multiaccess communications	Up to 64 RF Tags can be read.	

\* The default setting is for Automatic Mode. The Reader/Writer will automatically change to High-speed Mode or Standard Mode depending on the interference waves.

## V780-HMD68-ETN-RU

	Item	V780-HMD68-ETN-RU
Tag Communications Specifications	Applicable countries	Russia
	Maximum Radiated Power	2 W e.r.p
	Output power	15 to 27 dBm (Switchable in 1-dB increments.)
	RSSI detection range	Signal level: -35 to -61 dBm Noise level: -35 to -70 dBm (at end of antenna cable)
	Transmission speed from Reader/Writer to RF Tag	40 kbps (fixed)
	Transmission speed from RF Tag to Reader/Writer	<ul style="list-style-type: none"> <li>• 80 kbps (High-speed Mode) *</li> <li>• 31.25 kbps (Standard Mode) *</li> </ul>
	Used frequencies	3 channels (866.3/866.9/867.5 MHz) FHSS
	Channel interval	200 kHz
	Communications method with RF Tags	Miller-modulated subcarrier
	Tag communications protocol	ISO/IEC 18000-63: 2013 (EPCglobal Class-1 Generation-2)
	Polarization characteristic	RHCP
Multiaccess communications	Up to 64 RF Tags can be read.	

\* The default setting is for Automatic Mode. The Reader/Writer will automatically change to High-speed Mode or Standard Mode depending on the interference waves.

## V780-HMD68-ETN-US

	Item	V780-HMD68-ETN-US
Tag Communications Specifications	Applicable countries	United States and Canada
	Maximum Radiated Power	4 W e.i.r.p
	Output power	15 to 27 dBm (Switchable in 1-dB increments.)
	RSSI detection range	Signal level: -35 to -61 dBm Noise level: -35 to -70 dBm (at end of antenna cable)
	Transmission speed from Reader/Writer to RF Tag	40 kbps (fixed)
	Transmission speed from RF Tag to Reader/Writer	<ul style="list-style-type: none"> <li>• 80 kbps (High-speed Mode) *</li> <li>• 31.25 kbps (Standard Mode) *</li> </ul>
	Used frequencies	50 channels (902.75 to 927.25 MHz) FHSS
	Channel interval	500 kHz
	Communications method with RF Tags	Miller-modulated subcarrier
	Tag communications protocol	ISO/IEC 18000-63: 2013 (EPCglobal Class-1 Generation-2)
	Polarization characteristic	RHCP
Multiaccess communications	Up to 64 RF Tags can be read.	

\* The default setting is for Automatic Mode. The Reader/Writer will automatically change to High-speed Mode or Standard Mode depending on the interference waves.

## V780-HMD68-ETN-MX

Item		V780-HMD68-ETN-MX
Tag Communications Specifications	Applicable countries	Mexico
	Maximum Radiated Power	4 W e.i.r.p
	Output power	15 to 27 dBm (Switchable in 1-dB increments.)
	RSSI detection range	Signal level: -35 to -61 dBm Noise level: -35 to -70 dBm (at end of antenna cable)
	Transmission speed from Reader/Writer to RF Tag	40 kbps (fixed)
	Transmission speed from RF Tag to Reader/Writer	<ul style="list-style-type: none"> <li>• 80 kbps (High-speed Mode) *</li> <li>• 31.25 kbps (Standard Mode) *</li> </ul>
	Used frequencies	50 channels (902.75 to 927.25 MHz) FHSS
	Channel interval	500 kHz
	Communications method with RF Tags	Miller-modulated subcarrier
	Tag communications protocol	ISO/IEC 18000-63: 2013 (EPCglobal Class-1 Generation-2)
	Polarization characteristic	RHCP
	Multiaccess communications	Up to 64 RF Tags can be read.

\* The default setting is for Automatic Mode. The Reader/Writer will automatically change to High-speed Mode or Standard Mode depending on the interference waves.

## Recommended Power Supply (24 VDC)

Item	Condition
Supply voltage	24 VDC -15% to +10%
Output current	500 mA min.
Safety standard	SELV (Safety Extra Low Voltage)

## RF Tag (Recommended)

Item	Model	V780-A-JIME-Z3BLI-10 (made by Toppan Forms Co., Ltd.)
Dimensions		150 × 14 × 6 mm (W × H × D)
IC chip, memory		Monza X 8K Ull(EPC): 128 bits User memory: 8,192 bits
Data retention		10 years
Write life		10,000 writes
Operating temperature		-20 to 65°C
Operating humidity		5% to 95%
Storage temperature		-30 to 70°C
Storage humidity		5% to 95%
Material		Polycarbonate plastic
Weight		Tag: Approx. 15 g
Degree of protection		IP68 (IEC 60529: 2001)

## RF Tag Attachment (Recommended)

Item	Model	V780-A-TA-133 (made by Toppan Forms Co., Ltd.)
Dimensions		180 × 50 × 30 mm (W × H × D)
Operating temperature		-20 to 65°C
Operating humidity		5% to 95%
Storage temperature		-30 to 70°C
Storage humidity		5% to 95%
Material		Polycarbonate plastic
Weight		Approx. 128 g

# V780 Series

## Characteristic Data V780-HMD68-ETN-JP (for Reference Only)

### Communications range

The communications range differs depending on the radio regulations of each country. Moreover, the communications range may change under the influence of the ambient environment, type of RF Tags, and the items on which RF Tags are mounted. Sufficiently verify the communications range in advance.

**RF Tag : V780-A-JIME-Z3BLI-10 (Toppan Forms Co., Ltd.)**  
**(Back Surface: Metal, with Attachment, V780-A-TA-133-10)**

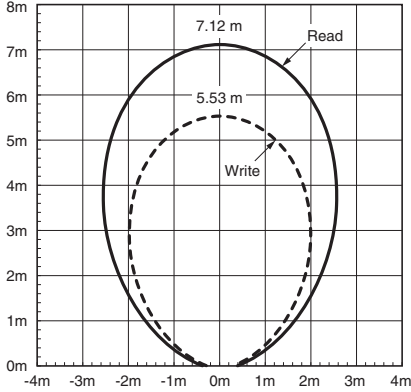

### RF Tag Communications Times

The communications time differs depending on the radio regulations of each country, or the settings of the RF communications command and RF communications speed. In actual usage, the communications time may change under the influence of the installation environment, system conditions, type of RF Tags, and other factors. Perform sufficient testing in advance.

**RF Tag : V780-A-JIME-Z3BLI-10 (Toppan Forms Co., Ltd.)**  
**ID READ (Single-access)**

During 6-word (96bit) data readout from the Ull (EPC) area

RF communications speed	Communications time
High speed	15 ms
Normal speed	27 ms

#### DATA READ (Single-access)

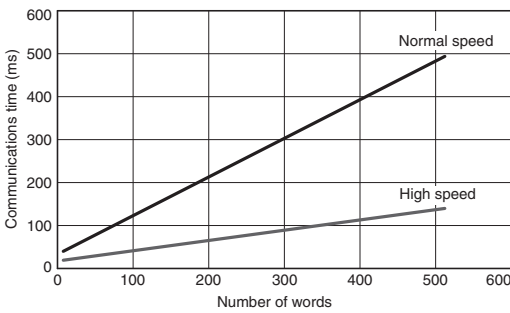

#### DATA WRITE (Single-access)

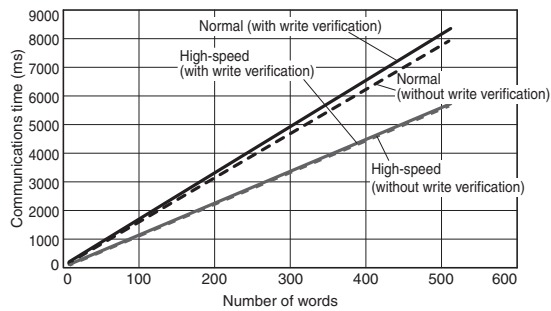

#### ID READ (Multi-access)

During 6-word (96bit) data readout from the Ull (EPC) area

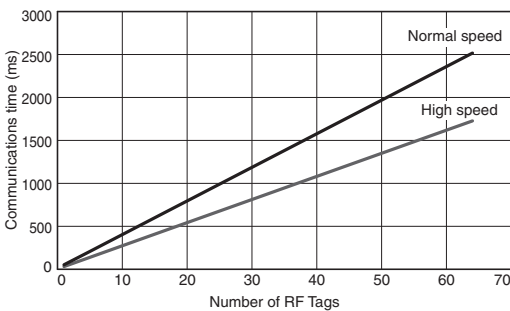

#### DATA READ (Multi-access)

Reading 32 Words of Data from the User Area

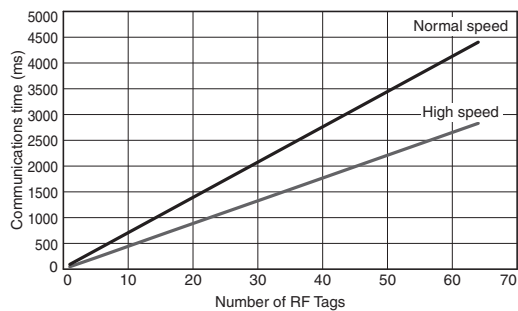



## Characteristic Data V780-HMD68-ETN-KR (for Reference Only)

### Communications range

The communications range differs depending on the radio regulations of each country. Moreover, the communications range may change under the influence of the ambient environment, type of RF Tags, and the items on which RF Tags are mounted. Sufficiently verify the communications range in advance.

**RF Tag : V780-A-JIME-Z3BLI-10 (Toppan Forms Co., Ltd.)**  
**(Back Surface: Metal, with Attachment, V780-A-TA-133-10)**

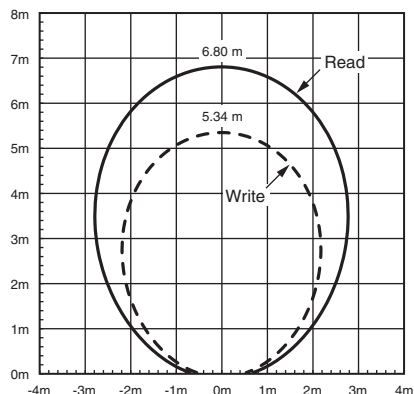

### RF Tag Communication Times

The communications time differs depending on the radio regulations of each country, or the settings of the RF communications command and RF communications speed. In actual usage, the communications time may change under the influence of the installation environment, system conditions, type of RF Tags, and other factors. Perform sufficient testing in advance.

**RF Tag : V780-A-JIME-Z3BLI-10 (Toppan Forms Co., Ltd.)**  
**ID READ (Single-access)**

During 6-word (96bit) data readout from the UII (EPC) area

RF communications speed	Communications time
High speed	21 ms
Normal speed	27 ms

#### DATA READ (Single-access)

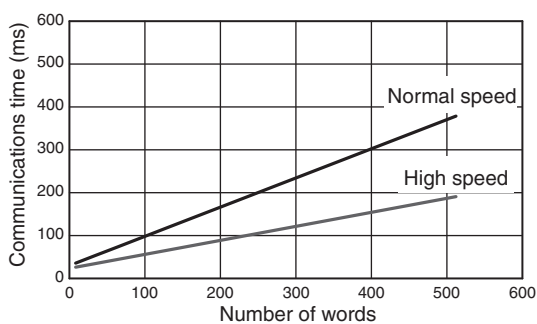

#### DATA WRITE (Single-access)

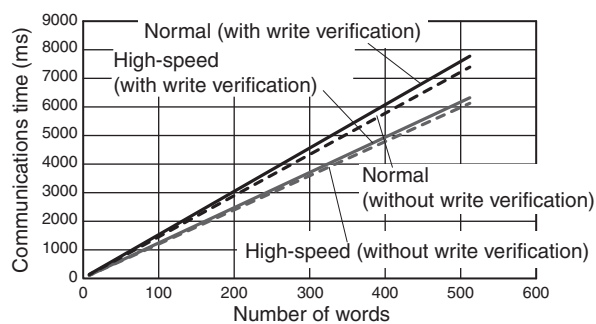

#### ID READ (Multi-access)

During 6-word (96bit) data readout from the UII (EPC) area

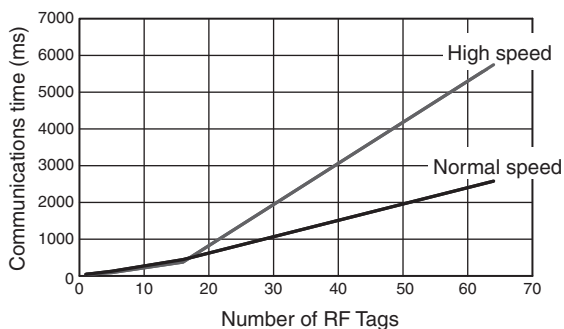

#### DATA READ (Multi-access)

Reading 32 Words of Data from the User Area

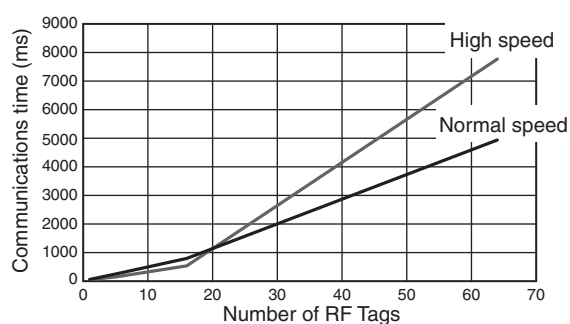

# V780 Series

## Characteristic Data V780-HMD68-ETN-CN (for Reference Only)

### Communications range

The communications range differs depending on the radio regulations of each country. Moreover, the communications range may change under the influence of the ambient environment, type of RF Tags, and the items on which RF Tags are mounted. Sufficiently verify the communications range in advance.

**RF Tag : V780-A-JIME-Z3BLI-10 (Toppan Forms Co., Ltd.)**  
**(Back Surface: Metal, with Attachment, V780-A-TA-133-10)**

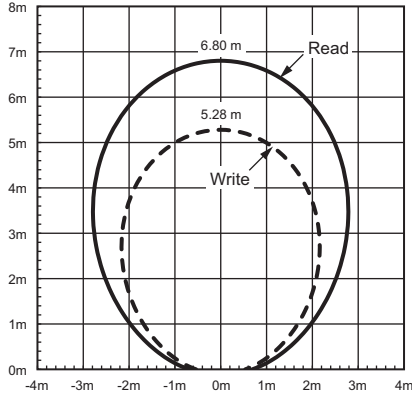

### RF Tag Communication Times

The communications time differs depending on the radio regulations of each country, or the settings of the RF communications command and RF communications speed. In actual usage, the communications time may change under the influence of the installation environment, system conditions, type of RF Tags, and other factors. Perform sufficient testing in advance.

**RF Tag : V780-A-JIME-Z3BLI-10 (Toppan Forms Co., Ltd.)**  
**ID READ (Single-access)**

During 6-word (96bit) data readout from the Ull (EPC) area

RF communications speed	Communications time
High speed	17 ms
Normal speed	29 ms

#### DATA READ (Single-access)

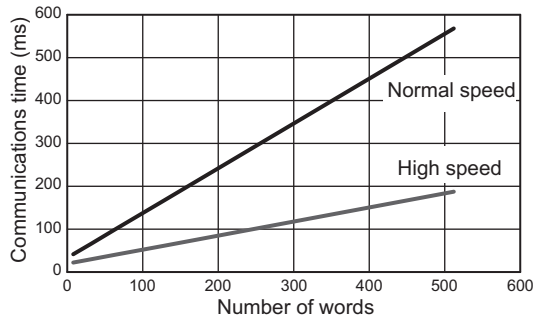

#### DATA WRITE (Single-access)

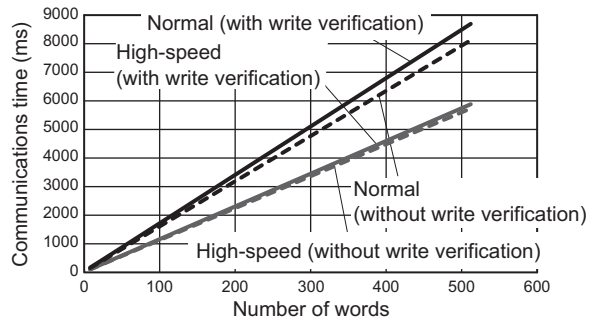

#### ID READ (Multi-access)

During 6-word (96bit) data readout from the Ull (EPC) area

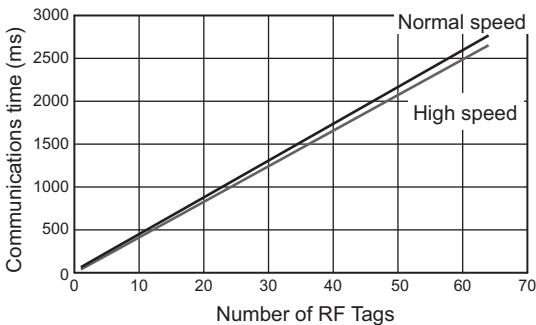

#### DATA READ (Multi-access)

Reading 32 Words of Data from the User Area

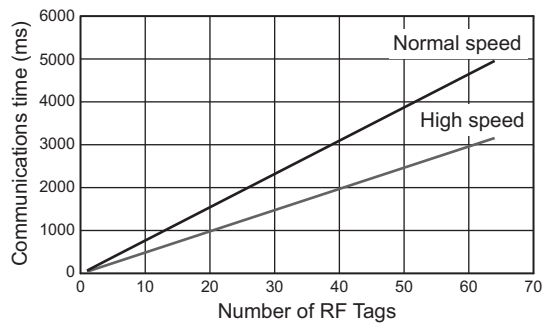

## Characteristic Data V780-HMD68-ETN-TW (for Reference Only)

### Communications range

The communications range differs depending on the radio regulations of each country. Moreover, the communications range may change under the influence of the ambient environment, type of RF Tags, and the items on which RF Tags are mounted. Sufficiently verify the communications range in advance.

**RF Tag : V780-A-JIME-Z3BLI-10 (Toppan Forms Co., Ltd.)**  
**(Back Surface: Metal, with Attachment, V780-A-TA-133-10)**

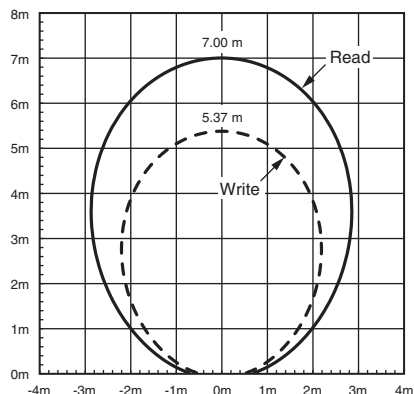

### RF Tag Communication Times

The communications time differs depending on the radio regulations of each country, or the settings of the RF communications command and RF communications speed. In actual usage, the communications time may change under the influence of the installation environment, system conditions, type of RF Tags, and other factors. Perform sufficient testing in advance.

**RF Tag : V780-A-JIME-Z3BLI-10 (Toppan Forms Co., Ltd.)**

#### ID READ (Single-access)

During 6-word (96bit) data readout from the UII (EPC) area

RF communications speed	Communications time
High speed	21 ms
Normal speed	27 ms

#### DATA READ (Single-access)

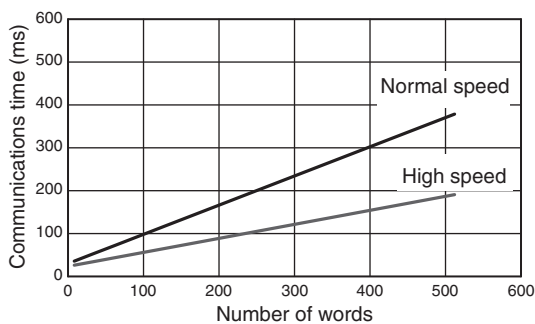

#### DATA WRITE (Single-access)

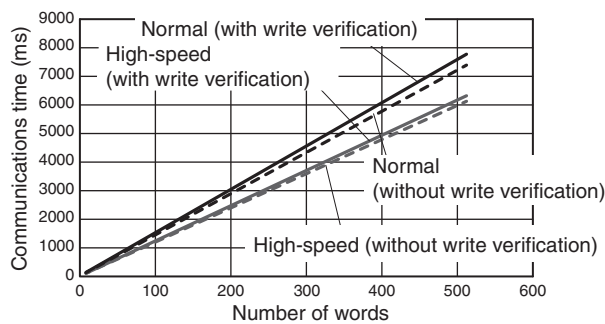

#### ID READ (Multi-access)

During 6-word (96bit) data readout from the UII (EPC) area

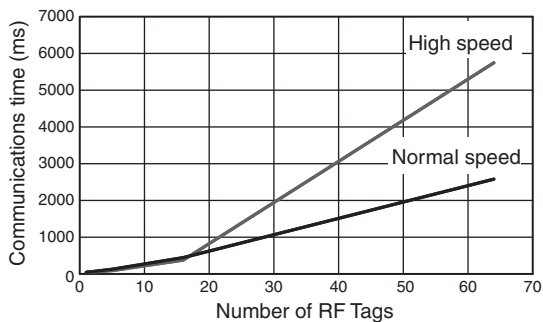

#### DATA READ (Multi-access)

Reading 32 Words of Data from the User Area

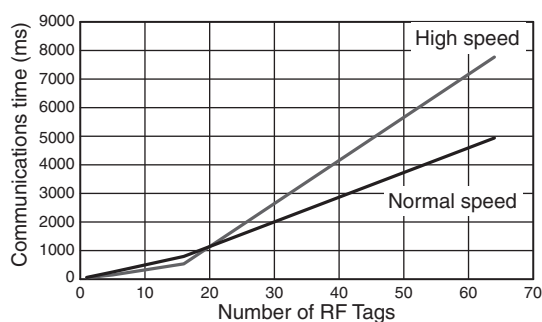

# V780 Series

## Characteristic Data V780-HMD68-ETN-IN (for Reference Only)

### Communications range

The communications range differs depending on the radio regulations of each country. Moreover, the communications range may change under the influence of the ambient environment, type of RF Tags, and the items on which RF Tags are mounted. Sufficiently verify the communications range in advance.

**RF Tag : V780-A-JIME-Z3BLI-10 (Toppan Forms Co., Ltd.)**  
**(Back Surface: Metal, with Attachment, V780-A-TA-133-10)**

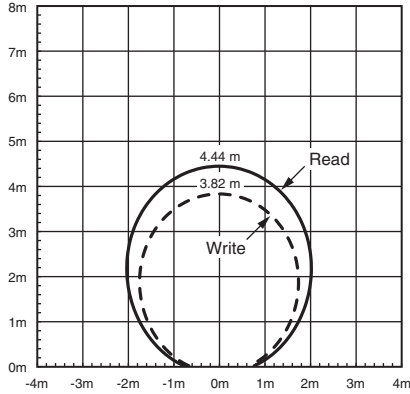

### RF Tag Communication Times

The communications time differs depending on the radio regulations of each country, or the settings of the RF communications command and RF communications speed. In actual usage, the communications time may change under the influence of the installation environment, system conditions, type of RF Tags, and other factors. Perform sufficient testing in advance.

**RF Tag : V780-A-JIME-Z3BLI-10 (Toppan Forms Co., Ltd.)**  
**ID READ (Single-access)**

During 6-word (96bit) data readout from the Ull (EPC) area

RF communications speed	Communications time
High speed	21 ms
Normal speed	27 ms

#### DATA READ (Single-access)

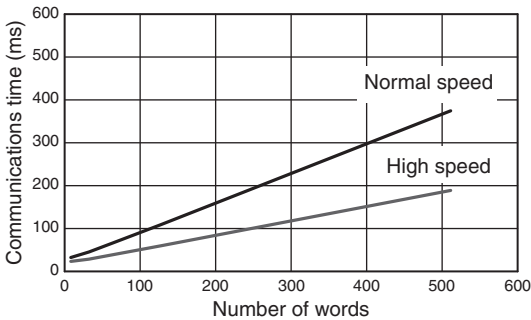

#### DATA WRITE (Single-access)

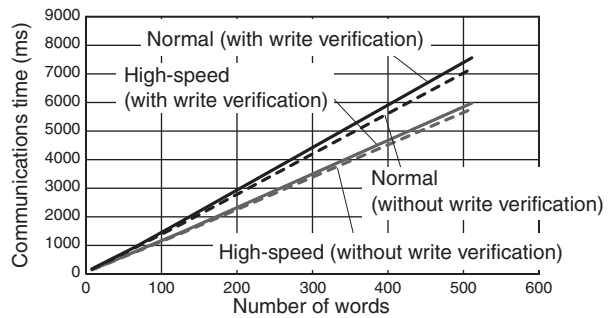

#### ID READ (Multi-access)

During 6-word (96bit) data readout from the Ull (EPC) area

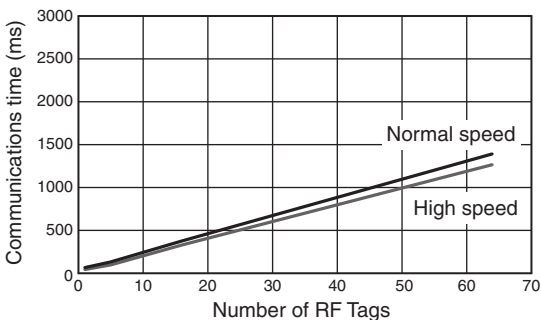

#### DATA READ (Multi-access)

Reading 32 Words of Data from the User Area

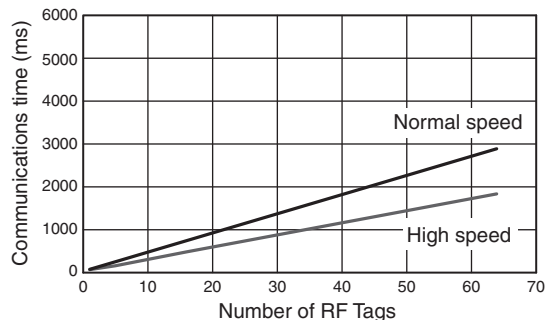

## Characteristic Data V780-HMD68-ETN-ID (for Reference Only)

### Communications range

The communications range differs depending on the radio regulations of each country. Moreover, the communications range may change under the influence of the ambient environment, type of RF Tags, and the items on which RF Tags are mounted. Sufficiently verify the communications range in advance.

**RF Tag : V780-A-JIME-Z3BLI-10 (Toppan Forms Co., Ltd.)**  
**(Back Surface: Metal, with Attachment, V780-A-TA-133-10)**

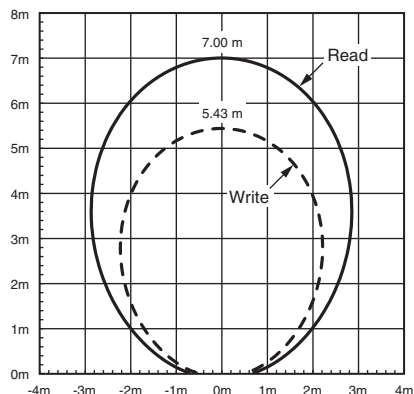

### RF Tag Communication Times

The communications time differs depending on the radio regulations of each country, or the settings of the RF communications command and RF communications speed. In actual usage, the communications time may change under the influence of the installation environment, system conditions, type of RF Tags, and other factors. Perform sufficient testing in advance.

**RF Tag : V780-A-JIME-Z3BLI-10 (Toppan Forms Co., Ltd.)**

#### ID READ (Single-access)

During 6-word (96bit) data readout from the UII (EPC) area

RF communications speed	Communications time
High speed	21 ms
Normal speed	27 ms

#### DATA READ (Single-access)

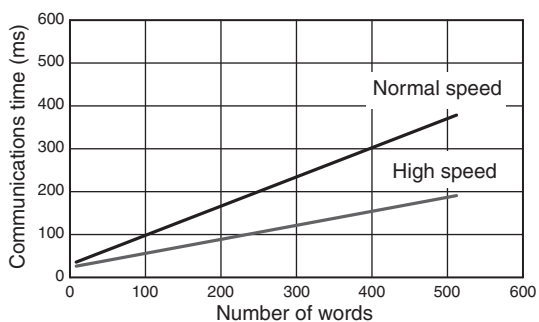

#### DATA WRITE (Single-access)

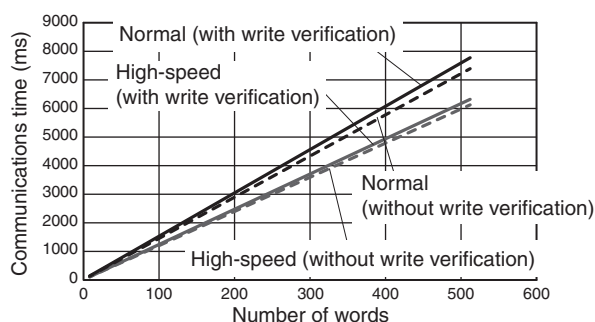

#### ID READ (Multi-access)

During 6-word (96bit) data readout from the UII (EPC) area

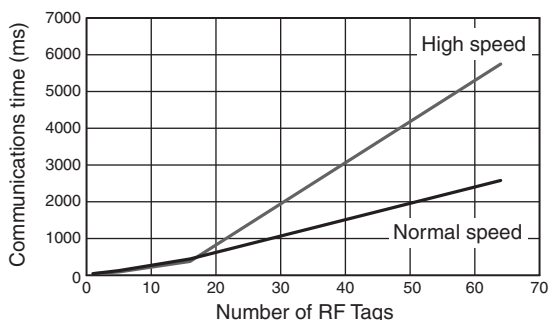

#### DATA READ (Multi-access)

Reading 32 Words of Data from the User Area

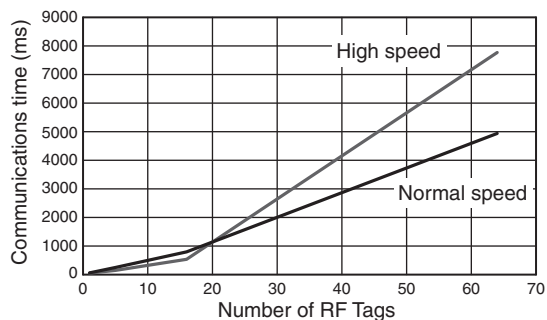

# V780 Series

## Characteristic Data V780-HMD68-ETN-MY (for Reference Only)

### Communications range

The communications range differs depending on the radio regulations of each country. Moreover, the communications range may change under the influence of the ambient environment, type of RF Tags, and the items on which RF Tags are mounted. Sufficiently verify the communications range in advance.

**RF Tag : V780-A-JIME-Z3BLI-10 (Toppan Forms Co., Ltd.)**  
**(Back Surface: Metal, with Attachment, V780-A-TA-133-10)**

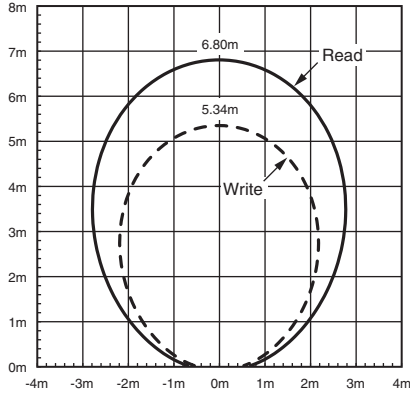

### RF Tag Communication Times

The communications time differs depending on the radio regulations of each country, or the settings of the RF communications command and RF communications speed. In actual usage, the communications time may change under the influence of the installation environment, system conditions, type of RF Tags, and other factors. Perform sufficient testing in advance.

**RF Tag : V780-A-JIME-Z3BLI-10 (Toppan Forms Co., Ltd.)**  
**ID READ (Single-access)**

During 6-word (96bit) data readout from the UII (EPC) area

RF communications speed	Communications time
High speed	21 ms
Normal speed	27 ms

#### DATA READ (Single-access)

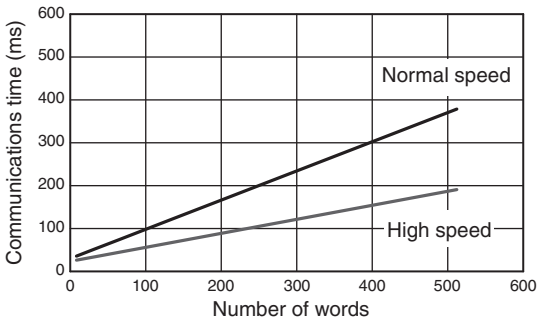

#### DATA WRITE (Single-access)

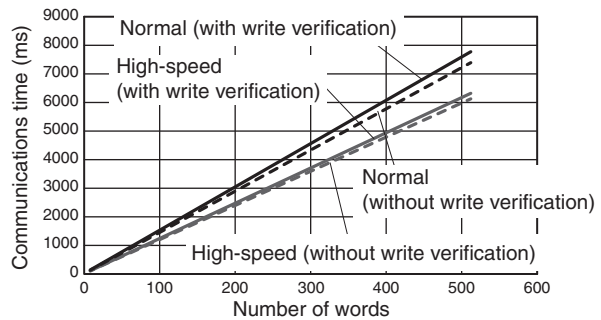

#### ID READ (Multi-access)

During 6-word (96bit) data readout from the UII (EPC) area

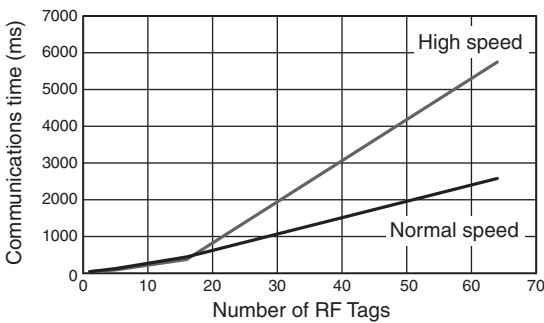

#### DATA READ (Multi-access)

Reading 32 Words of Data from the User Area

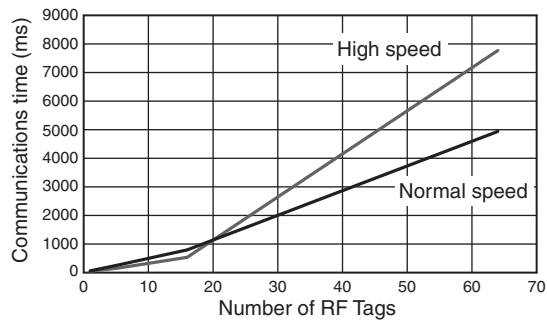

## Characteristic Data V780-HMD68-ETN-SG (for Reference Only)

### Communications range

The communications range differs depending on the radio regulations of each country. Moreover, the communications range may change under the influence of the ambient environment, type of RF Tags, and the items on which RF Tags are mounted. Sufficiently verify the communications range in advance.

**RF Tag : V780-A-JIME-Z3BLI-10 (Toppan Forms Co., Ltd.)**  
**(Back Surface: Metal, with Attachment, V780-A-TA-133-10)**

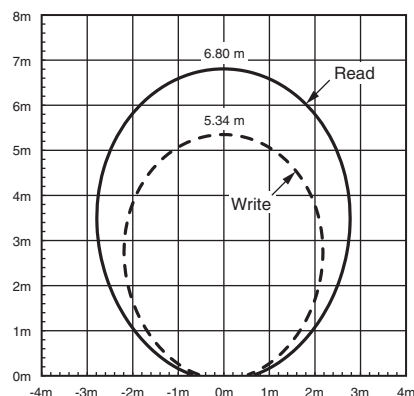

### RF Tag Communication Times

The communications time differs depending on the radio regulations of each country, or the settings of the RF communications command and RF communications speed. In actual usage, the communications time may change under the influence of the installation environment, system conditions, type of RF Tags, and other factors. Perform sufficient testing in advance.

**RF Tag : V780-A-JIME-Z3BLI-10 (Toppan Forms Co., Ltd.)**

#### ID READ (Single-access)

During 6-word (96bit) data readout from the UII (EPC) area

RF communications speed	Communications time
High speed	21 ms
Normal speed	27 ms

#### DATA READ (Single-access)

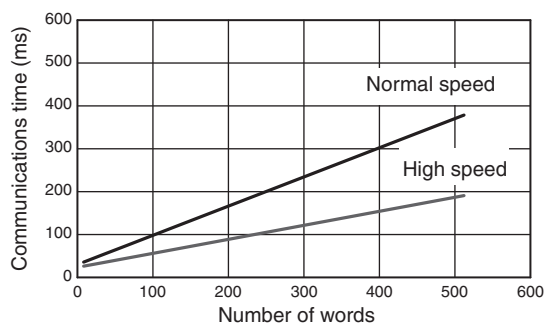

#### DATA WRITE (Single-access)

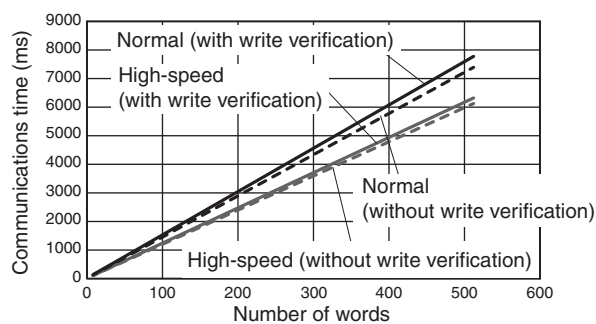

#### ID READ (Multi-access)

During 6-word (96bit) data readout from the UII (EPC) area

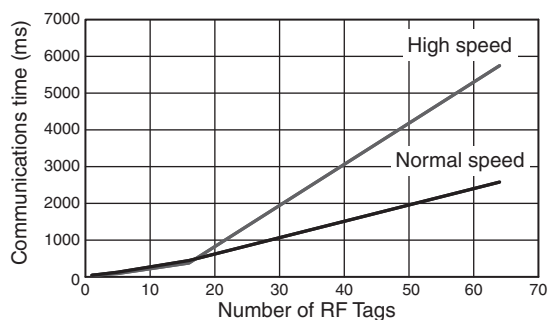

#### DATA READ (Multi-access)

Reading 32 Words of Data from the User Area

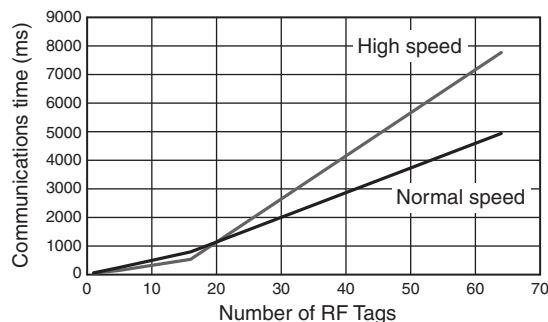

# V780 Series

## Characteristic Data V780-HMD68-ETN-EU (for Reference Only)

### Communications range

The communications range differs depending on the radio regulations of each country. Moreover, the communications range may change under the influence of the ambient environment, type of RF Tags, and the items on which RF Tags are mounted. Sufficiently verify the communications range in advance.

**RF Tag : V780-A-JIME-Z3BLI-10 (Toppan Forms Co., Ltd.)**  
**(Back Surface: Metal, with Attachment, V780-A-TA-133-10)**

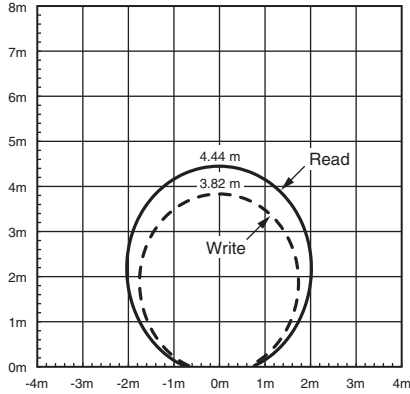

### RF Tag Communication Times

The communications time differs depending on the radio regulations of each country, or the settings of the RF communications command and RF communications speed. In actual usage, the communications time may change under the influence of the installation environment, system conditions, type of RF Tags, and other factors. Perform sufficient testing in advance.

**RF Tag : V780-A-JIME-Z3BLI-10 (Toppan Forms Co., Ltd.)**  
**ID READ (Single-access)**

During 6-word (96bit) data readout from the UII (EPC) area

RF communications speed	Communications time
High speed	21 ms
Normal speed	27 ms

#### DATA READ (Single-access)

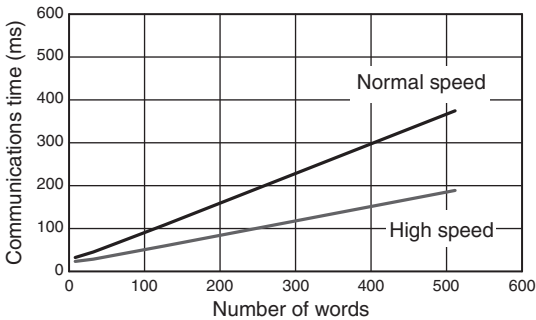

#### DATA WRITE (Single-access)

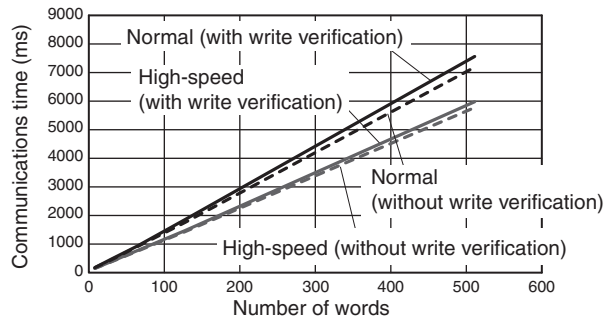

#### ID READ (Multi-access)

During 6-word (96bit) data readout from the UII (EPC) area

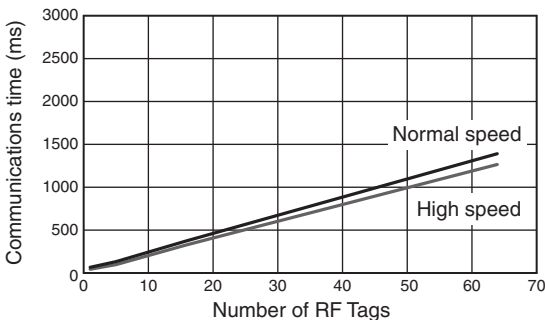

#### DATA READ (Multi-access)

Reading 32 Words of Data from the User Area

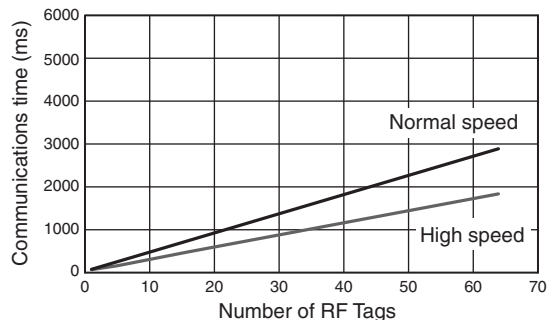



## Characteristic Data V780-HMD68-ETN-RU (for Reference Only)

### Communications range

The communications range differs depending on the radio regulations of each country. Moreover, the communications range may change under the influence of the ambient environment, type of RF Tags, and the items on which RF Tags are mounted. Sufficiently verify the communications range in advance.

**RF Tag : V780-A-JIME-Z3BLI-10 (Toppan Forms Co., Ltd.)**  
**(Back Surface: Metal, with Attachment, V780-A-TA-133-10)**

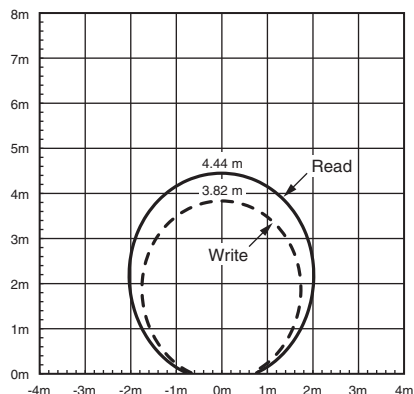

### RF Tag Communication Times

The communications time differs depending on the radio regulations of each country, or the settings of the RF communications command and RF communications speed. In actual usage, the communications time may change under the influence of the installation environment, system conditions, type of RF Tags, and other factors. Perform sufficient testing in advance.

**RF Tag : V780-A-JIME-Z3BLI-10 (Toppan Forms Co., Ltd.)**

#### ID READ (Single-access)

During 6-word (96bit) data readout from the UII (EPC) area

RF communications speed	Communications time
High speed	21 ms
Normal speed	27 ms

#### DATA READ (Single-access)

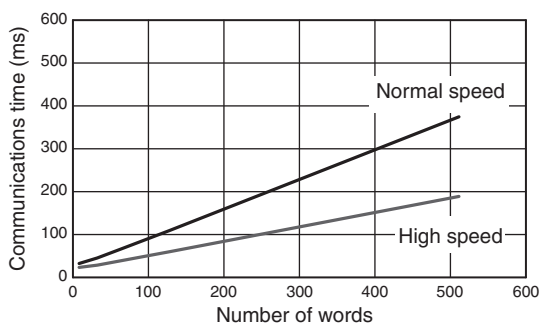

#### DATA WRITE (Single-access)

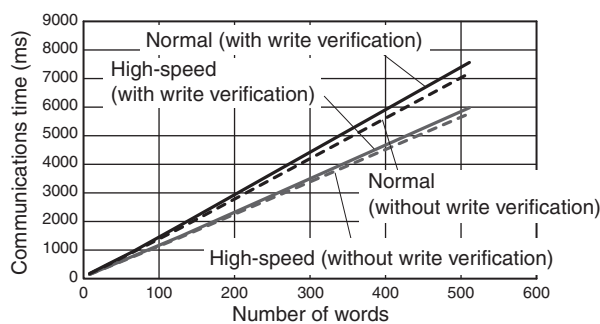

#### ID READ (Multi-access)

During 6-word (96bit) data readout from the UII (EPC) area

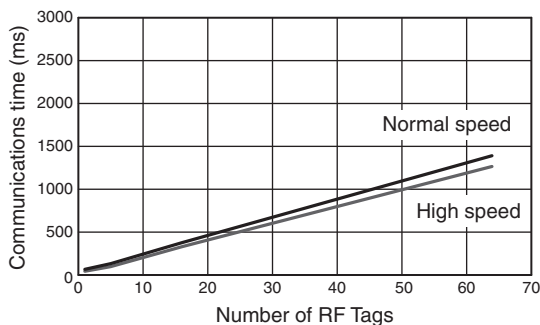

#### DATA READ (Multi-access)

Reading 32 Words of Data from the User Area

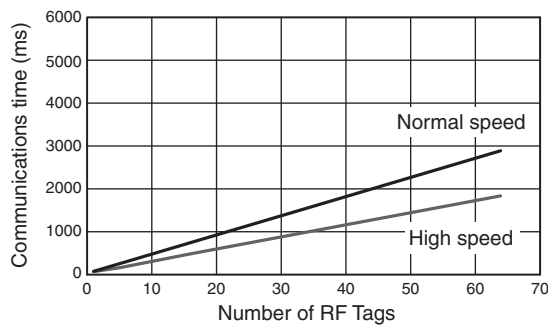

# V780 Series

## Characteristic Data V780-HMD68-ETN-US (for Reference Only)

### Communications range

The communications range differs depending on the radio regulations of each country. Moreover, the communications range may change under the influence of the ambient environment, type of RF Tags, and the items on which RF Tags are mounted. Sufficiently verify the communications range in advance.

**RF Tag : V780-A-JIME-Z3BLI-10 (Toppan Forms Co., Ltd.)**  
**(Back Surface: Metal, with Attachment, V780-A-TA-133-10)**

Transmission power: 27dBm

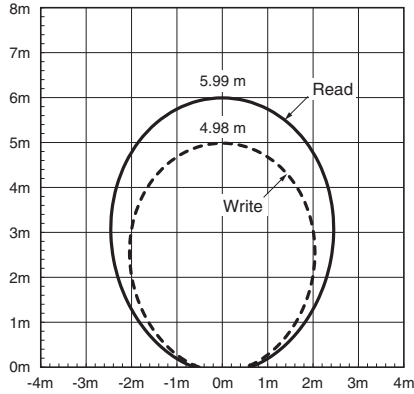

### RF Tag Communication Times

The communications time differs depending on the radio regulations of each country, or the settings of the RF communications command and RF communications speed. In actual usage, the communications time may change under the influence of the installation environment, system conditions, type of RF Tags, and other factors. Perform sufficient testing in advance.

**RF Tag : V780-A-JIME-Z3BLI-10 (Toppan Forms Co., Ltd.)**

#### ID READ (Single-access)

During 6-word (96bit) data readout from the Ull (EPC) area

RF communications speed	Communications time
High speed	21 ms
Normal speed	27 ms

#### DATA READ (Single-access)

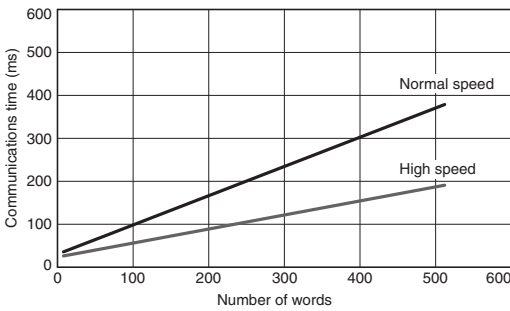

#### DATA WRITE (Single-access)

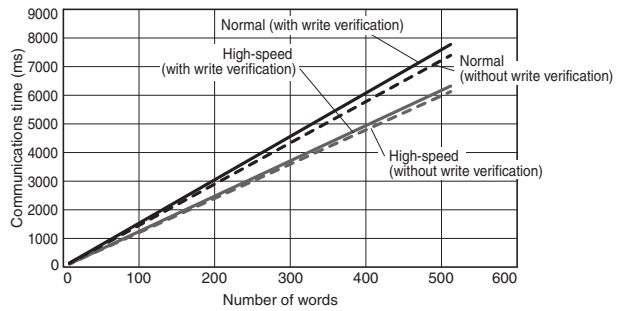

**Note:** Refer to the V780 Series User's Manual for details.

#### ID READ (Multi-access)

During 6-word (96bit) data readout from the Ull (EPC) area

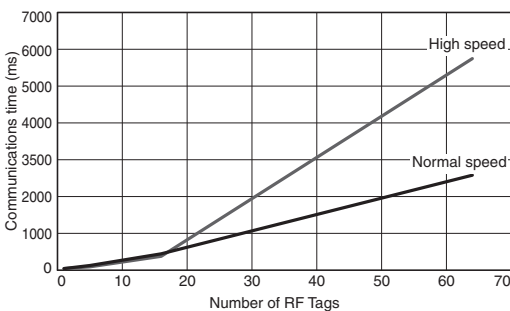

#### DATA READ (Multi-access)

Reading 32 Words of Data from the User Area

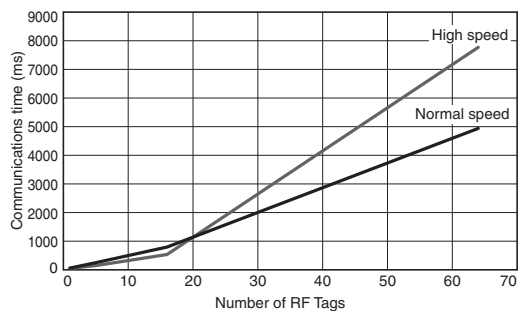

**Note:** 1. If you set the RF communications speed to high speed, there will generally be a higher rate of collisions in communications with RF Tags than for the normal speed. Therefore, if there are too many RF Tags, the high speed may actually result in longer communications times.  
 2. Refer to the V780 Series User's Manual for details.

## Characteristic Data V780-HMD68-ETN-MX (for Reference Only)

### Communications range

The communications range differs depending on the radio regulations of each country. Moreover, the communications range may change under the influence of the ambient environment, type of RF Tags, and the items on which RF Tags are mounted. Sufficiently verify the communications range in advance.

**RF Tag : V780-A-JIME-Z3BLI-10 (Toppan Forms Co., Ltd.)**  
**(Back Surface: Metal, with Attachment, V780-A-TA-133-10)**

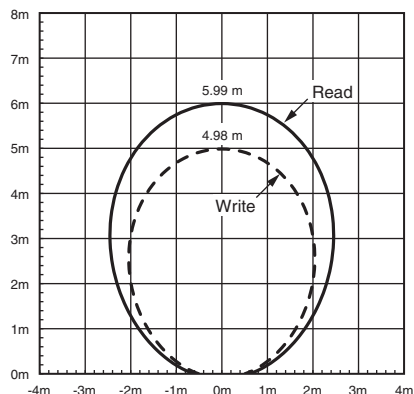

### RF Tag Communication Time

The communications time differs depending on the radio regulations of each country, or the settings of the RF communications command and RF communications speed. In actual usage, the communications time may change under the influence of the installation environment, system conditions, type of RF Tags, and other factors. Perform sufficient testing in advance.

**RF Tag : V780-A-JIME-Z3BLI-10 (Toppan Forms Co., Ltd.)**

#### ID READ (Single-access)

During 6-word (96bit) data readout from the UII (EPC) area

RF communications speed	Communications time
High speed	21 ms
Normal speed	27 ms

#### DATA READ (Single-access)

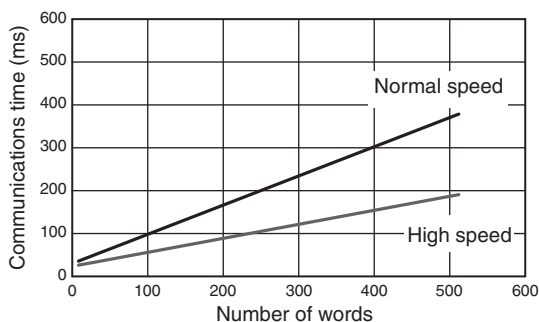

#### DATA WRITE (Single-access)

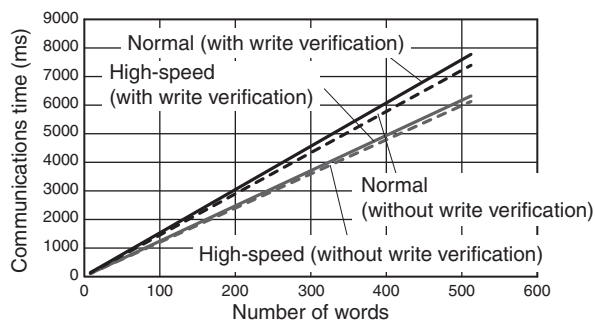

#### ID READ (Multi-access)

During 6-word (96bit) data readout from the UII (EPC) area

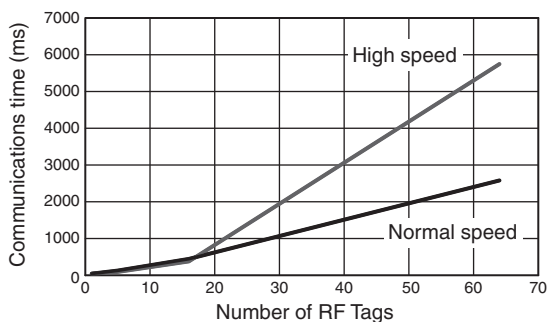

#### DATA READ (Multi-access)

Reading 32 Words of Data from the User Area

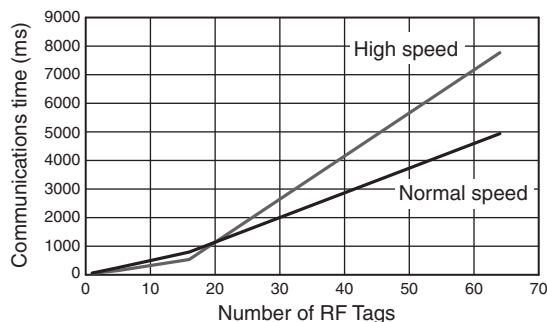

# V780 Series

## Dimensions

(Unit: mm)

Tolerance class IT16 applies to dimensions in this datasheet unless otherwise specified.

### Reader/Writer

V780-HMD68-ETN-□□

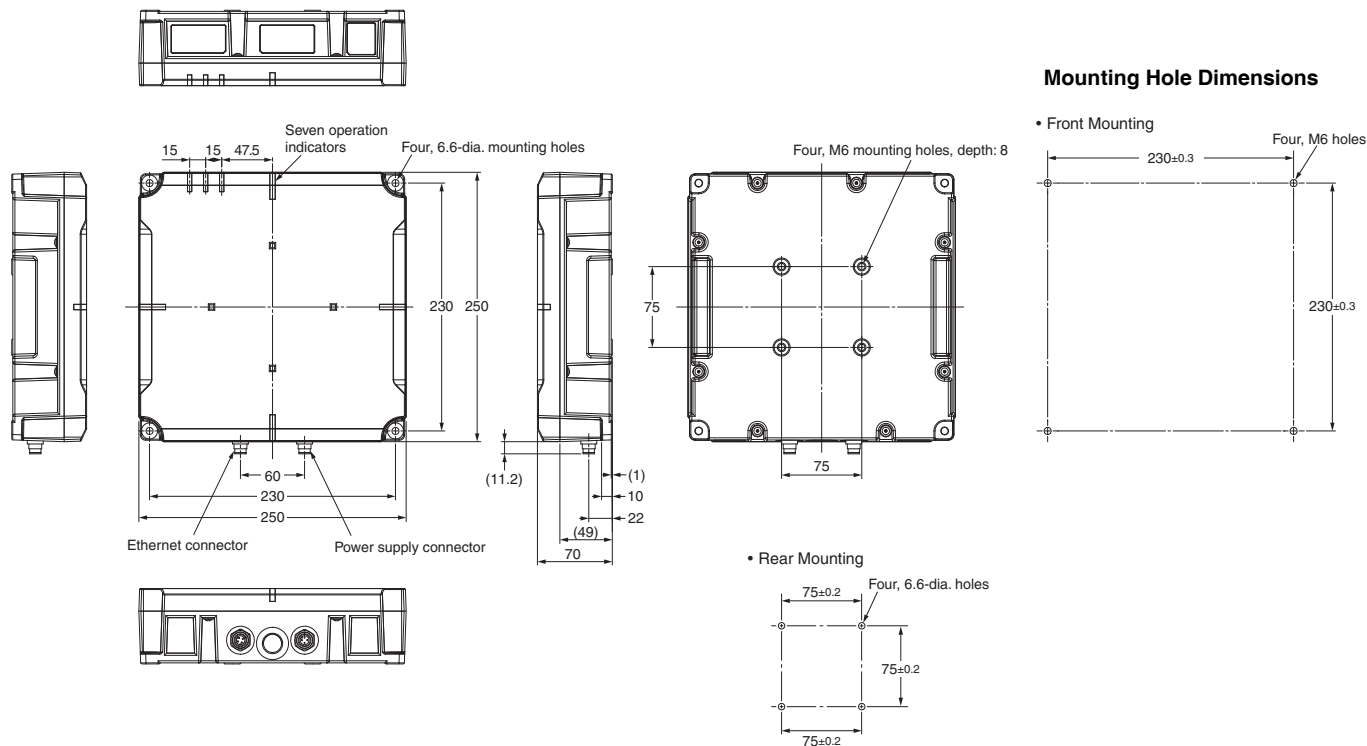

### RF Tag

V780-A-JIME-Z3BLI-10 (Toppan Forms Co., Ltd. Model Number: JIME-Z3BLI)

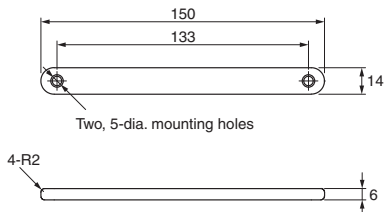

#### Mounting Hole Dimensions

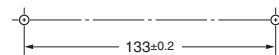

Case material	Polycarbonate plastic
---------------	-----------------------

### RF Tag Attachment

V780-A-TA-133-10 (Toppan Forms Co., Ltd. Model Number: TA-133)

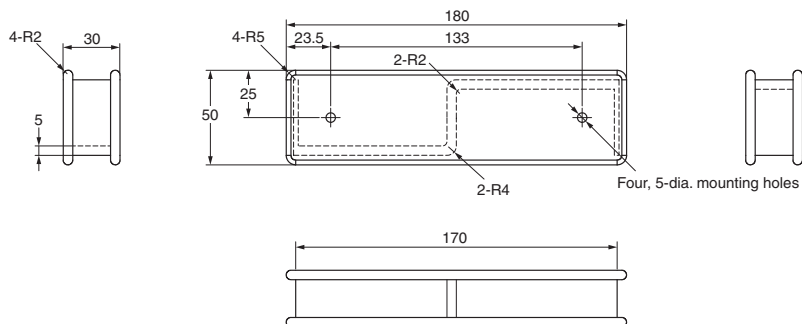

#### Mounting Hole Dimensions

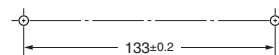

Material	Polycarbonate plastic
----------	-----------------------

## Related Manuals

Cat. No.	Name
Z389-E1	UHF RFID System V780-series Reader/Writer User's Manual

# Terms and Conditions Agreement

## Read and understand this catalog.

Please read and understand this catalog before purchasing the products. Please consult your OMRON representative if you have any questions or comments.

## Warranties.

- (a) Exclusive Warranty. Omron's exclusive warranty is that the Products will be free from defects in materials and workmanship for a period of twelve months from the date of sale by Omron (or such other period expressed in writing by Omron). Omron disclaims all other warranties, express or implied.
- (b) Limitations. OMRON MAKES NO WARRANTY OR REPRESENTATION, EXPRESS OR IMPLIED, ABOUT NON-INFRINGEMENT, MERCHANTABILITY OR FITNESS FOR A PARTICULAR PURPOSE OF THE PRODUCTS. BUYER ACKNOWLEDGES THAT IT ALONE HAS DETERMINED THAT THE PRODUCTS WILL SUITABLY MEET THE REQUIREMENTS OF THEIR INTENDED USE.

Omron further disclaims all warranties and responsibility of any type for claims or expenses based on infringement by the Products or otherwise of any intellectual property right. (c) Buyer Remedy. Omron's sole obligation hereunder shall be, at Omron's election, to (i) replace (in the form originally shipped with Buyer responsible for labor charges for removal or replacement thereof) the non-complying Product, (ii) repair the non-complying Product, or (iii) repay or credit Buyer an amount equal to the purchase price of the non-complying Product; provided that in no event shall Omron be responsible for warranty, repair, indemnity or any other claims or expenses regarding the Products unless Omron's analysis confirms that the Products were properly handled, stored, installed and maintained and not subject to contamination, abuse, misuse or inappropriate modification. Return of any Products by Buyer must be approved in writing by Omron before shipment. Omron Companies shall not be liable for the suitability or unsuitability or the results from the use of Products in combination with any electrical or electronic components, circuits, system assemblies or any other materials or substances or environments. Any advice, recommendations or information given orally or in writing, are not to be construed as an amendment or addition to the above warranty.

See <http://www.omron.com/global/> or contact your Omron representative for published information.

## Limitation on Liability; Etc.

OMRON COMPANIES SHALL NOT BE LIABLE FOR SPECIAL, INDIRECT, INCIDENTAL, OR CONSEQUENTIAL DAMAGES, LOSS OF PROFITS OR PRODUCTION OR COMMERCIAL LOSS IN ANY WAY CONNECTED WITH THE PRODUCTS, WHETHER SUCH CLAIM IS BASED IN CONTRACT, WARRANTY, NEGLIGENCE OR STRICT LIABILITY.

Further, in no event shall liability of Omron Companies exceed the individual price of the Product on which liability is asserted.

## Suitability of Use.

Omron Companies shall not be responsible for conformity with any standards, codes or regulations which apply to the combination of the Product in the Buyer's application or use of the Product. At Buyer's request, Omron will provide applicable third party certification documents identifying ratings and limitations of use which apply to the Product. This information by itself is not sufficient for a complete determination of the suitability of the Product in combination with the end product, machine, system, or other application or use. Buyer shall be solely responsible for determining appropriateness of the particular Product with respect to Buyer's application, product or system. Buyer shall take application responsibility in all cases.

NEVER USE THE PRODUCT FOR AN APPLICATION INVOLVING SERIOUS RISK TO LIFE OR PROPERTY OR IN LARGE QUANTITIES WITHOUT ENSURING THAT THE SYSTEM AS A WHOLE HAS BEEN DESIGNED TO ADDRESS THE RISKS, AND THAT THE OMRON PRODUCT(S) IS PROPERLY RATED AND INSTALLED FOR THE INTENDED USE WITHIN THE OVERALL EQUIPMENT OR SYSTEM.

## Programmable Products.

Omron Companies shall not be responsible for the user's programming of a programmable Product, or any consequence thereof.

## Performance Data.

Data presented in Omron Company websites, catalogs and other materials is provided as a guide for the user in determining suitability and does not constitute a warranty. It may represent the result of Omron's test conditions, and the user must correlate it to actual application requirements. Actual performance is subject to the Omron's Warranty and Limitations of Liability.

## Change in Specifications.

Product specifications and accessories may be changed at any time based on improvements and other reasons. It is our practice to change part numbers when published ratings or features are changed, or when significant construction changes are made. However, some specifications of the Product may be changed without any notice. When in doubt, special part numbers may be assigned to fix or establish key specifications for your application. Please consult with your Omron's representative at any time to confirm actual specifications of purchased Product.

## Errors and Omissions.

Information presented by Omron Companies has been checked and is believed to be accurate; however, no responsibility is assumed for clerical, typographical or proofreading errors or omissions.

**Note: Do not use this document to operate the Unit.**

**OMRON Corporation** Industrial Automation Company  
Kyoto, JAPAN

**Contact: [www.ia.omron.com](http://www.ia.omron.com)**

**Regional Headquarters**

**OMRON EUROPE B.V.**

Wegalaan 67-69, 2132 JD Hoofddorp  
The Netherlands

Tel: (31)2356-81-300/Fax: (31)2356-81-388

**OMRON ELECTRONICS LLC**

2895 Greenspoint Parkway, Suite 200  
Hoffman Estates, IL 60169 U.S.A.

Tel: (1) 847-843-7900/Fax: (1) 847-843-7787

**OMRON ASIA PACIFIC PTE. LTD.**

No. 438A Alexandra Road # 05-05/08 (Lobby 2),  
Alexandra Technopark,  
Singapore 119967

Tel: (65) 6835-3011/Fax: (65) 6835-2711

**OMRON (CHINA) CO., LTD.**

Room 2211, Bank of China Tower,  
200 Yin Cheng Zhong Road,  
PuDong New Area, Shanghai, 200120, China

Tel: (86) 21-5037-2222/Fax: (86) 21-5037-2200

**Authorized Distributor:**

© OMRON Corporation 2017 All Rights Reserved.  
In the interest of product improvement,  
specifications are subject to change without notice.

**CSM\_1\_4\_1217**  
**Cat. No. Q256-E1-05**

1217(0517)