

# OMRON

## Fixed Laser-Type Barcode Reader

V500-R2 Series

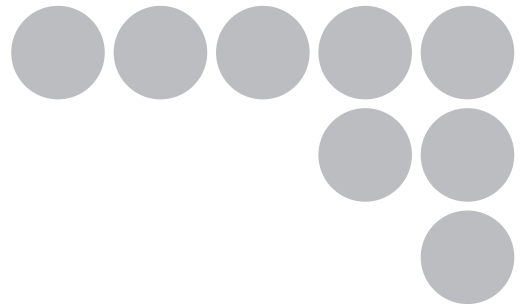

## User's Manual



Cat. No. Z334-E1-01A

## Introduction

Thank you for purchasing the OMRON V500-R2 series. This manual describes the functions, performance, and application methods of the V500-R2 series.

This manual is intended for personnel with knowledge of electrical systems. Be sure to read and understand this manual thoroughly before using the product, and keep this manual in an easily accessible location for quick reference when required.

Introduction	READ AND UNDERSTAND THIS DOCUMENT (Be sure to read this.)
Section 1	Product Overview
Section 2	Wiring and Installation
Section 3	Function Explanation
Section 4	Setting Method
Section 5	Example of System Configuration
Section 6	Appendix

Introduction

Section 1

Section 2

Section 3

Section 4

Section 5

Appendix

# Bar Code Reader User's Manual

V500-R2 series

## **READ AND UNDERSTAND THIS DOCUMENT**

Please read and understand this document before using the products. Please consult your OMRON representative if you have any questions or comments.

## **WARRANTY**

OMRON's exclusive warranty is that the products are free from defects in materials and workmanship for a period of one year (or other period if specified) from date of sale by OMRON.

OMRON MAKES NO WARRANTY OR REPRESENTATION, EXPRESS OR IMPLIED, REGARDING NON-INFRINGEMENT, MERCHANTABILITY, OR FITNESS FOR PARTICULAR PURPOSE OF THE PRODUCTS. ANY BUYER OR USER ACKNOWLEDGES THAT THE BUYER OR USER ALONE HAS DETERMINED THAT THE PRODUCTS WILL SUITABLY MEET THE REQUIREMENTS OF THEIR INTENDED USE. OMRON DISCLAIMS ALL OTHER WARRANTIES, EXPRESS OR IMPLIED.

## **LIMITATIONS OF LIABILITY**

OMRON SHALL NOT BE RESPONSIBLE FOR SPECIAL, INDIRECT, OR CONSEQUENTIAL DAMAGES, LOSS OF PROFITS OR COMMERCIAL LOSS IN ANY WAY CONNECTED WITH THE PRODUCTS, WHETHER SUCH CLAIM IS BASED ON CONTRACT, WARRANTY, NEGLIGENCE, OR STRICT LIABILITY.

In no event shall responsibility of OMRON for any act exceed the individual price of the product on which liability is asserted.

IN NO EVENT SHALL OMRON BE RESPONSIBLE FOR WARRANTY, REPAIR, OR OTHER CLAIMS REGARDING THE PRODUCTS UNLESS OMRON'S ANALYSIS CONFIRMS THAT THE PRODUCTS WERE PROPERLY HANDLED, STORED, INSTALLED, AND MAINTAINED AND NOT SUBJECT TO CONTAMINATION, ABUSE, MISUSE, OR INAPPROPRIATE MODIFICATION OR REPAIR.

## **SUITABILITY FOR USE**

THE PRODUCTS CONTAINED IN THIS DOCUMENT ARE NOT SAFETY RATED. THEY ARE NOT DESIGNED OR RATED FOR ENSURING SAFETY OF PERSONS, AND SHOULD NOT BE RELIED UPON AS A SAFETY COMPONENT OR PROTECTIVE DEVICE FOR SUCH PURPOSES. Please refer to separate catalogs for OMRON's safety rated products.

OMRON shall not be responsible for conformity with any standards, codes, or regulations that apply to the combination of products in the customer's application or use of the product.

At the customer's request, OMRON will provide applicable third party certification documents identifying ratings and limitations of use that apply to the products. This information by itself is not sufficient for a complete determination of the suitability of the products in combination with the end product, machine, system, or other application or use.

The following are some examples of applications for which particular attention must be given. This is not intended to be an exhaustive list of all possible uses of the products, nor is it intended to imply that the uses listed may be suitable for the products:

- Outdoor use, uses involving potential chemical contamination or electrical interference, or conditions or uses not described in this document.

- Nuclear energy control systems, combustion systems, railroad systems, aviation systems, medical equipment, amusement machines, vehicles, safety equipment, and installations subject to separate industry or government regulations.
- Systems, machines, and equipment that could present a risk to life or property.

Please know and observe all prohibitions of use applicable to the products.

NEVER USE THE PRODUCTS FOR AN APPLICATION INVOLVING SERIOUS RISK TO LIFE OR PROPERTY WITHOUT ENSURING THAT THE SYSTEM AS A WHOLE HAS BEEN DESIGNED TO ADDRESS THE RISKS, AND THAT THE OMRON PRODUCT IS PROPERLY RATED AND INSTALLED FOR THE INTENDED USE WITHIN THE OVERALL EQUIPMENT OR SYSTEM.

### **PERFORMANCE DATA**

Performance data given in this document is provided as a guide for the user in determining suitability and does not constitute a warranty. It may represent the result of OMRON's test conditions, and the users must correlate it to actual application requirements. Actual performance is subject to the OMRON Warranty and Limitations of Liability.

### **CHANGE IN SPECIFICATIONS**

Product specifications and accessories may be changed at any time based on improvements and other reasons.

It is our practice to change model numbers when published ratings or features are changed, or when significant construction changes are made. However, some specifications of the product may be changed without any notice. When in doubt, special model numbers may be assigned to fix or establish key specifications for your application on your request. Please consult with your OMRON representative at any time to confirm actual specifications of purchased products.

### **DIMENSIONS AND WEIGHTS**

Dimensions and weights are nominal and are not to be used for manufacturing purposes, even when tolerances are shown.

### **ERRORS AND OMISSIONS**

The information in this document has been carefully checked and is believed to be accurate; however, no responsibility is assumed for clerical, typographical, or proofreading errors, or omissions.

### **PROGRAMMABLE PRODUCTS**

OMRON shall not be responsible for the user's programming of a programmable product, or any consequence thereof.

### **COPYRIGHT AND COPY PERMISSION**

This document shall not be copied for sales or promotions without permission.

This document is protected by copyright and is intended solely for use in conjunction with the product. Please notify us before copying or reproducing this document in any manner, for any other purpose. If copying or transmitting this document to another, please copy or transmit it in its entirety.

## Meanings of Signal Words

In this manual, precautions are indicated using the following symbols and signal words to ensure safe use of the V500-R2 series. The precautions indicated by these symbols and signal words are important for safety and must be observed.



**WARNING**

Indicates a potentially hazardous situation which, if not avoided, will result in minor or moderate injury, or may result in serious injury or death. Additionally there may be significant property damage.



**CAUTION**

Indicates a potentially hazardous situation which, if not avoided, may result in minor or moderate injury or in property damage.

## Meanings of Alert Symbols



Indicates the possibility of laser radiation.



Indicates prohibition when there is a risk of minor injury from electrical shock or other source if the product is disassembled.



Indicates instruction for the user to always connect the ground wire.

## For the Safety Use of Laser Products

- Warning display

### WARNING

Avoid eye exposure to direct or scattered radiation reflected by a mirror surface.

Laser beam emitted from a laser has high power density and may become blind when the beam is directed into eyes.



Do not disassemble this bar code reader.

Laser beam may be scattered around when it is disassembled.



- Caution display

### CAUTION

Caution-Use of controls or adjustments or performance of procedures other than those specifies herein may result in hazardous radiation exposure.



This Bar Code Reader uses a laser as the light source.

Lasers are classified on IEC standard (IEC 60825-1).

	V500-R2CF
Wavelength	650 nm
Peak power	1 mW max.
Classification	2

### Labeling on Laser Use

This Bar Code Reader has the following WARNING Label.

This Bar Code Reader is compliant with IEC 60825 and the U.S. FDA (Food and Drug Administration) laser regulations.



## Usage

- Use laser enclosure device to prevent specular object from reflecting laser beam.  
When used without an enclosure, be sure to avoid a laser path from eye level.
- Although the safety distance (NOHD) is approximately 1 m; it is advisable, however, to terminate the laser on its path if possible. Nonreflective, flattening material is recommendable for termination.
- Wear protective glasses to protect against laser light during set up and adjustment.

## Outline of IEC 60825-1 Standard

The following are the safety measures to be taken by the user for each type of laser equipment.

Classification Required items	Class 1	Class 2	Class 3A	Class 3B*	Class 4
Remote interlock	Not required			Connect to room or door circuits.	
Key control	Not required			Remove key when not in use.	
Beam attenuator	Not required			When in use prevents inadvertent exposure.	
Emission indicator device	Not required			Indicates laser is energized.	
Warning signs	Not required			Follow precautions on warning signs.	
Beam path	Not required	Terminate beam at end of useful length.			
Specular reflection	Not required			Prevent unintentional reflections.	
Eye protection	Not required			Required if engineering and administrative procedures not practicable and MPE exceeded.	
Protective clothing	Not required			Sometimes required.	Specific requirements.
Training	Not required		Required for all operator and maintenance personnel.		

\* With respect to the requirements of remote interlock connector, key control, beam attenuator, emission indicator device, and eye protection, Class 3B laser products not exceeding five times the AEL of Class 2 in the wavelength range of 400 nm to 700 nm are to be treated as Class 3A laser products.



## Precautions for Safe Use

Observe the following precautions to ensure safe use of the product.

### 1. Installation Environment

- Do not use the product in environments containing flammable or explosive gases.
- Do not use the product in environments containing corrosive or combustible gases.
- Do not use the product in environments containing dust, salt, or metallic powders.
- Do not use the product in environments containing droplets, water or mist, oil or chemical agents.
- Do not use the product in environments that may be affected by a CRT's flashing or other ambient light.
- Do not install or use the product outdoors.
- For the purpose of ensuring safe operation and maintenance, do not install the product close to high-voltage devices or electrically powered devices.

### 2. Power Supply and Wiring

- To assure noise and insulation resistance, be sure to use S8VS-01505 (made by OMRON) as a driving power supply.
- Do not connect a voltage or AC power supply that has a voltage exceeding the rating voltage (5 V $\pm$ 10%).
- Avoid reverse connection of power supply. Do not short circuit a load on OK/NG output signal (open collector).
- Avoid applying a load that exceeds the rating.
- Be sure to turn the power OFF before connecting or disconnecting a cable. Connecting or disconnecting a cable while the power is ON may cause failure.
- Connect different cables from high-voltage or power cables to the product. If the same cable or duct is used, electromagnetic induction may result, which may result in malfunction or damage.
- Tighten the fixing screws at the torque specified in this manual.

### 3. Communication with Upper Equipment

- Check that the product has started up, and then start communication with upper equipment.
- Indefinite signals may be generated from the upper interface while the product starts up. Clear the receive buffer of the devices before starting initial operation.

## 4. Other

- Do not use the product in a safety circuit for nuclear or life-support systems.
- Never attempt to disassemble, repair, modify, deform by applying pressure, or burn the product.
- Dispose of the product as industrial waste.
- If the product becomes extremely hot, or abnormal odors or smoke are emitted, stop using the product immediately, turn the power OFF, and consult with your OMRON representative.

## 5. Regulations and standards

This product complies with the following standards.

Laser safety standards: IEC 60825-1:2007 (2nd Edition) Class 2

JIS C 6802 Class 2

EN Standard (CE mark): EN55022/EN55024

## Precautions for Correct Use

Always observe the following precautions to prevent operation failures, malfunctions, and adverse effects on performance and equipment.

### 1. Installation location

- The product must not be installed in a place:
  - where ambient temperature is outside the range defined in the specifications,
  - where a rapid temperature change (dew condensation) occurs,
  - where ambient humidity is outside the range defined in the specifications,
  - where direct vibration or shock may affect the product,
  - where exposed to intense ambient light (laser, arc welding, or UV light),
  - where exposed to direct sunlight or heat from heating appliances, and
  - where a strong magnetic or electric field exists.
  
- Because of the protection rating described in the manual, avoid using locations containing:
  - corrosive or combustible gases,
  - dust, salt, or metallic powders,
  - droplets, water mist, oil or chemical agents.

### 2. Power supply, connection, and wiring

- Be sure to use S8VS-01505 (made by OMRON) as a driving power supply.
- Do not install the product in a location where a high-voltage device is installed.
- Be sure to use the supplied insulation board to assure the noise resistance.
- After connecting the cables, check that the correct power supply is used, that there is no load short-circuiting or other inappropriate connections, and that the load current is correct before turning the power ON. Faulty wiring may be the cause of failure.
- Use a wrist strap or other similar device to avoid electrostatic charge when you touch terminals and signal lines within a connector, and to avoid damage due to static electricity.
- Try to keep the length of the power cable to a minimum (less than 3 m).

### 3. Installation

- When installing this code reader, use the provided insulating plate and mounting bracket.
- Use the provided screws for installation, and tighten to the torque specified in these instructions.
- Incline the bar code reader about 15° to read the target bar code.
- Do not apply stress on the cable when mounting and using.

- V500-R2 series are precision instruments. Be careful not to give an impact or make them fall.
- Do not hold the sensor only by the cable part when moving the sensor. A sensor body part will be damaged.
- Distance and angle allowed to read differs according the bar code. Check if the used bar code can be read actually, before mounting.

#### 4. Timing input with photo-electronic sensor

When taking timing with the photo-electronic sensor, mount the bar code reader so that the footlight beam of the photo-electronic sensor does not spot directly on the reading window of the bar code reader or on the bar code.

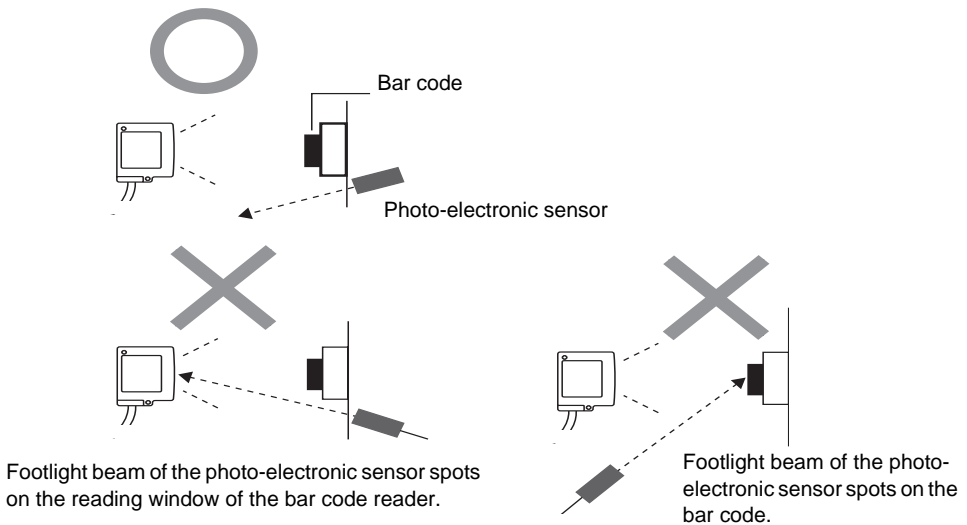

#### 5. Influence of reflective objects

When there is any reflective object such as metal or mirror surface on the bar code beam-scanning surface, reading character may be deteriorate. Cover the reflective object with something or change the bar code position to avoid influence.

## 6. Mutual interference

When mounting the bar code readers side-by-side, laser beams may interfere reading each other. The bar code readers should be placed far enough not to affect reading.

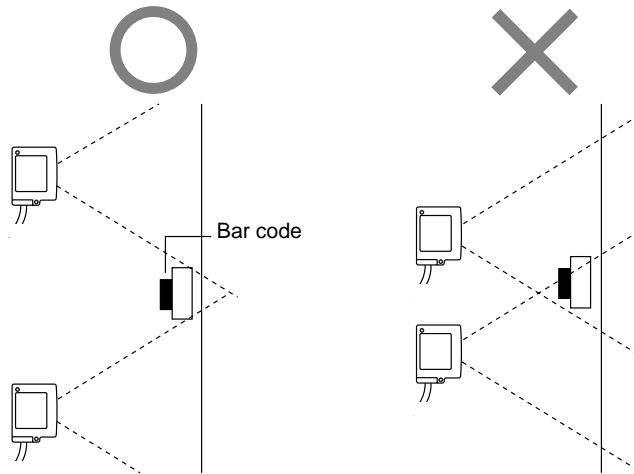

## 7. Bar code label

- The height of the bar code should be more than the luster scan width (max. 10 mm) and use a label considering attaching error.
- When reading bar code, margin is necessary on the both sides of the bar code. Set the label so that margin parts do not hide. A space of one character or more and 2.5 mm or more is necessary of both right and left side of the label. (Rough standard: 12 or 13 times or more of the narrow bar width)



## 8. To improve reading reliability

- When the digit is determined, designate the digit to use the bar code.
- Use the modulus check (addition of check digit).
- Bar codes other than the reading object should be set to reading prohibition.

 p.62

## 9. Maintenance and check

- Check for any dust or dirt on the reading window regularly. When it is dirty, wipe with a dry, soft and clean cloth. Do not use solutions such as thinner.
- Handle with care, not to apply strong shock such as dropping.

# How to Use This Manual

In this manual, each part of the bar code is described as follows.

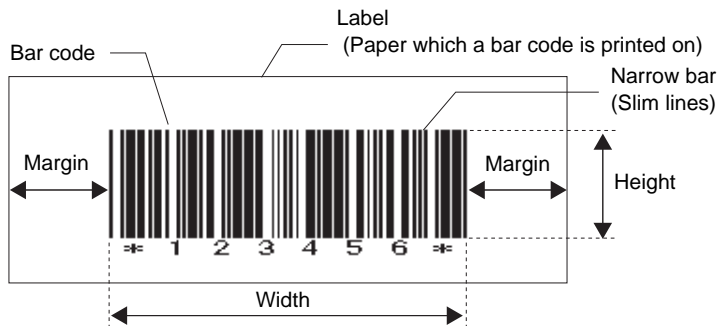

## For a page format

The screenshot shows a page from a manual with several annotations. On the right side, dashed lines and arrows point to specific elements:
 

- Section title:** Points to the header 'Section 4 System Settings'.
- Outline:** Points to the page number '4' in the top right corner.
- Move to the setting screen.:** Points to a menu option 'Select Setting Reader - Create Data...'.
- Screen display:** Points to a screenshot of a software configuration window.
- Index label:** Points to a vertical label 'Section 4 Uploading from the Memory Card'.
- Describes the settings.:** Points to a table of communication settings.

**Section 4 System Settings**

### Creating Setting Files Using the 2DCR Configear

Creates the data setting file for loading set data to the Handheld 2D Code Reader. Make the settings for the communications conditions, functions, and display conversion.

Select Setting Reader - Create Data... from the menu.  
The following window for creating the setting data file will be displayed.

**Open**  
Opens the previously created data setting file for editing. The [Receive (R)] function can be used to open the data file downloaded from the Code Reader and edit it.

**Save**  
Saves the created data setting file.

**CHECK!**  
To save data to the Memory Card, create a folder with the name SETTINGS, and save. If the data is saved to a folder other than "SETTINGS", it cannot be uploaded.

**Communication Settings**  
The settings shown in the following table are set in the Communication Settings Tab Page in the Create Setting Data Window.

Setting Item	Settings
Baud Rate	9,600, 19,200, or 38,400
Parity	None, odd, or even
Data Length	77 bits or 8 bits
Stop Bit	1sbit* or 2 bits
Header/Footer	Prefix: None*, 02 <STX>, or 1B <ESC>
	Suffix: ETX, 0A LF, 0D CR, or 0D0A CR+LF
	FCS: ON or OFF*

The default settings are indicated with an asterisk.

V500-R2 series User's Manual 65

V500-R2 series User's Manual 69

Procedure and additional explanations

Information useful during the operation and reference pages are provided here with special marks to indicate the kind of information being provided.



\*This page does not actually exist in this manual.

# Visual Aids

---



Indicates points that are important in using product functions or in application procedures.

CHECK!



Indicates page numbers providing related information.



Indicates helpful information when a problem occurs and explanations of technical terms.

# Contents

---

## Introduction

---

Meanings of Signal Words	4
Meanings of Alert Symbols	4
For the Safety Use of Laser Products	5
Precautions for Safe Use	7
Precautions for Correct Use	9
How to Use This Manual	12
Visual Aids	13
Contents	14

---

## Section 1 Product Overview

---

Features	18
Product Composition	20
Part Names	21
Rating/Performance	22
Usage Flow Chart	27

---

## Section 2 Wiring and Installation

---

Wiring	30
Installation	33

---

## Section 3 Function Explanation

---

Explanation of Reading System	36
Operation Flow Chart	37
Communication Data Format	45
Test Reading Function	48

---



Section 4	Setting Method	51
	How to Use Menu Sheet/Command	52
	Menu Sheet/Command List	56
Section 5	Example of System Configuration	97
	Example of Connection with a PC	98
	Example of Connection with Programmable Controller (CS1)	99
	Example of Multi-drop Connection	102
	How to Use Command Link Unit V700-L12	106
Section 6	Appendix	123
	External Dimension	124
	Troubleshooting	129
	ASCII Code Table	130
	Explanation of Terms	131
	Corresponding Bar Code List	136
	Revision History	140

MEMO

# Section 1

## Product Overview

This section explains about features and rating/performance of this bar code reader.

☒ Features	18
☒ Product Composition	20
☒ Part Names	21
☒ Rating/Performance	22
☒ Usage Flow Chart	27

# Features

A bar code reader is a device to read a bar code attached on a product and transfer the information to upper equipment.

Various types of information can be managed efficiently by using it combining with PC and programmable controllers.

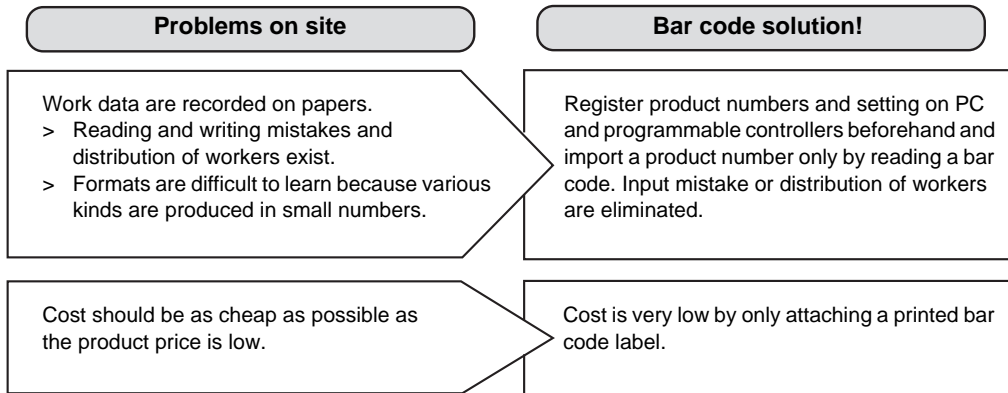

## ▪ Ultra-compact design

Optimum for the assembly to each device

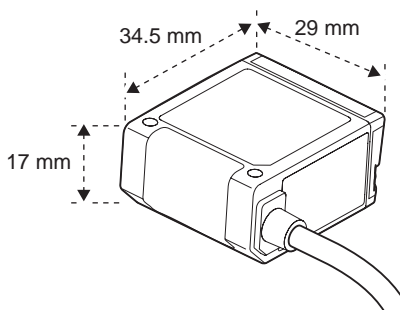

## ▪ Easy installation

Easy to read by pressing the SCAN button and know the reading rate with LED illumination and buzzer sound in real time.

As reading position is easy to check at site before connecting with upper equipment, installation work and maintenance work hour can be greatly reduced.

 p.48

## ▪ Simple function setting

You can either set the function by reading a menu sheet or by inputting a command on the upper equipment. You can select the setting method according to the condition.

 p.52

- Perfect reading performance

High speed reading with 1000 scan/sec. realized high reliability and wide reading distance of 70 mm to 330 mm (in case of narrow bar width 1.0 mm).

 p.24

- Easy multi-drop

Connect communication link unit V700-L12 to collect read data from plural bar code readers (max. 31) for one set of upper equipment.

 p.102

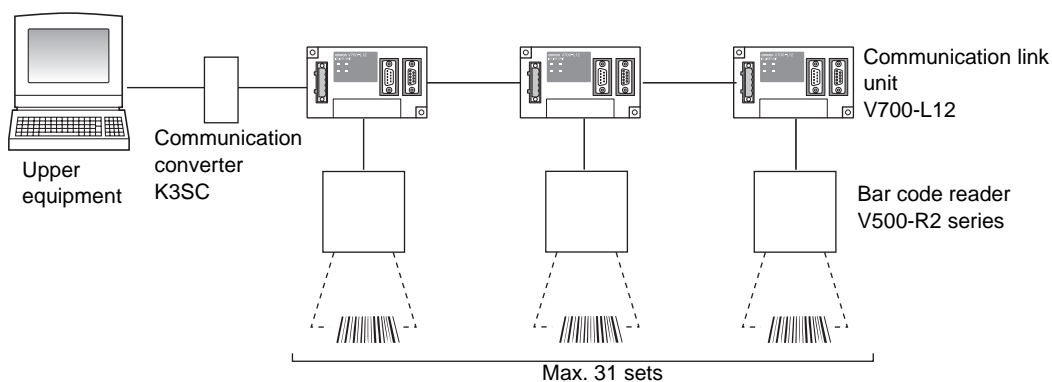

# Product Composition

The bar code reader is used by connecting with upper equipment such as PC and programmable controllers.

The upper equipment receives information which the bar code reader reads and refers with the registered information and records.

## V500-R2 series

Tip of the cable is a connector. Use an appropriate connecting cable according to the upper equipment.

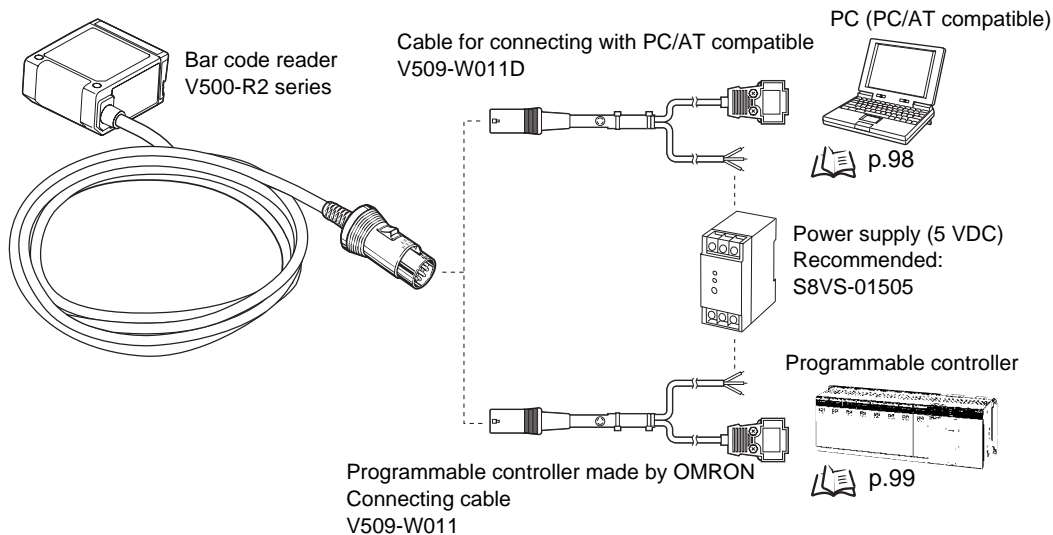

# Part Names

## Front side

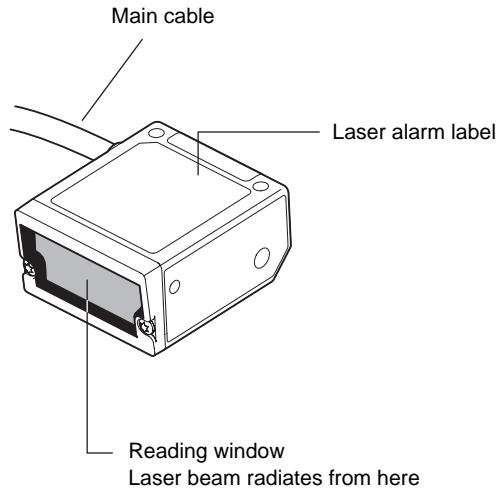

## Back side

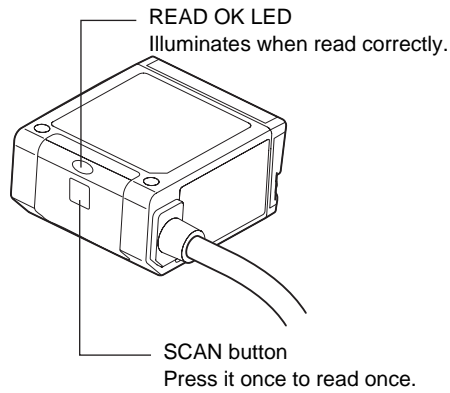

# Rating/Performance

## General specification

Model		V500-R2CF
Direction of view		Front view
Applicable codes	Bar code	WPC(JAN/EAN/UPC), Codabar(NW-7), ITF,Industrial2of5(STF), Code39, Code93, Code128, GS1-128(EAN-128), GS1-Databar(RSS-14), GS1-Databar Limited(RSS Limited), GS1-Databar Expanded(RSS Expanded)
	Number of reading digits	No upper limit (depends on bar width and reading distance)
Reading performance (*)	Minimum resolution	Bar code: 0.15 mm
	Contrast (PCS)	0.45 or more (white reflectance 70 % or more)
	Reading distance	60 to 270 mm (At narrow bar: 0.5 mm)
	Reading angle	Within 40° (Including margins at left and right sides)
	Skew angle ( $\alpha$ )	$\pm 60^\circ$ (However, exclude from 10° upper side to 7° lower side)
	Pitch angle ( $\beta$ )	$\pm 30^\circ$
	Tilt angle ( $\gamma$ )	$\pm 25^\circ$
	Reading of bar codes on curved surfaces (R)	$R \geq 20\text{mm}$ (UPC 12 digit)
	Light source	Red laser diode (Wave length: 650 nm)
	Light output	1.0m W or less (Correspond to JIS class 2)
	Scan type	Raster scan
Interface	Communication specification	RS-232C
	OK/NG outputs	NPN open collector output (cable work required)
Function setting method		Menu sheet reading method or host command method
Functional specifications	Reading trigger	External trigger (Transistor input) Trigger by command (RS-232C) Trigger a test reading by pressing the SCAN button on the product
	OK/NG signals	OK signal is turned on to indicate a successful read NG signal is turned on to indicate a successful read of a non-registered label
	Indication LED	OK LED (green) illuminates to indicate a successful read
	Buzzer	Notifies a successful reading with a buzzer sound (Muting available)
Power supply specification	Power voltage	4.5 to 5.5 VDC
	Consumption current	During operation: 500 mA or less; during standby: 150 mA or less
	Inrush current	2.0 A MAX



Environmental specifications	Ambient temperature range	At operation: 0 to + 45°C; At storage: -20 to + 60°C
	Ambient humidity range	At operation and storage: 20 to 85% RH (with no icing or condensation)
	Ambient atmosphere	No corrosive gases
	Ambient light	Fluorescent lamp: 4,000lx or less, Sunlight: 80,000lx or less
	Vibration resistance	10 to 150 Hz, half amplitude 0.35 mm, 3 directions (X/Y/Z), 8 minutes each 10 times
Degree of protection		IP54 (IEC60529)
Weight	Main unit only	Approximately 80 g
	Including accessories	Approximately 190 g (including mounting bracket, insulation plate and screws)
	Packaged weight	Approximately 270 g (including packing carton)
Dimensions	Main unit	Approximately 29(W) × 34.5(D) × 17(H)mm
	Packing carton	Approximately 245(W) × 110(D) × 40(H)mm
Input/output connector		Round DIN connector
Code length		Approximately 1.5 m
Minimum bending radius of cord		Approximately 23 mm
Accessories		Operation manual, menu sheet, mounting bracket, insulation plate, M3 × 6 screw (two), M3 × 8 screws (one), M5 × 10 screws (two)
Material, Color	Upper side case	Die-cast magnesium, black
	Front panel	PC, black
	Label	PET
	Reading window	PMMA, transparent
	Cable	Polyvinyl chloride (PVC), black
	Insulation plate	ABS, black
	Mounting bracket	SUS304, silver

\* Unless otherwise specified, use a JAN x1, MRD 63% or higher (PCS = 0.9 or higher) barcode with a pitch angle  $\alpha = 0^\circ$ , a skew angle  $\beta = 15^\circ$ , a tilt angle  $\gamma = 0^\circ$ , and a curvature  $R = \infty$ .

## Number of reading range performance

Explained with examples of following conditions:

- Contrast: MRD 63 % (PCS = 0.9)
- Bar code: CODE39
- Installation condition: Pitch angle  $\alpha = 0^\circ$ , skew angle  $\beta = 15^\circ$   
Tilt angle  $\gamma = 0^\circ$ , curvature  $R = \infty$

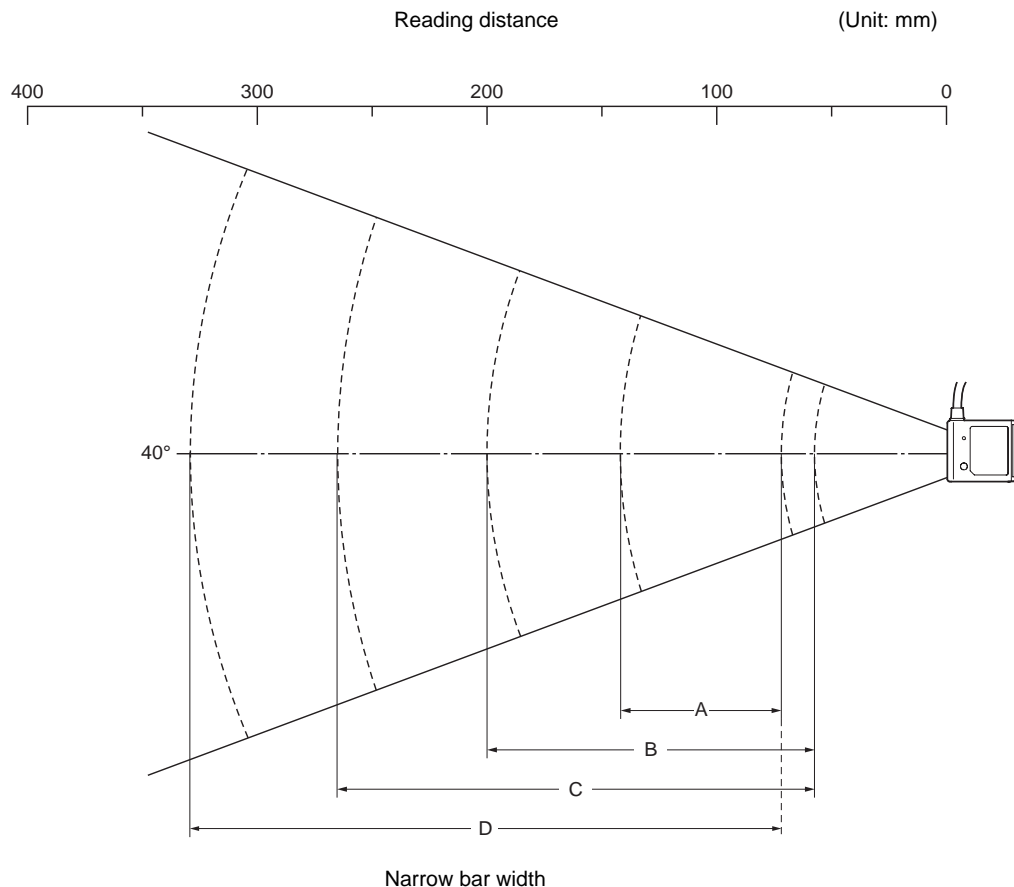

Narrow bar width		Reading distance (*1)
A	0.15 mm	70 to 140 mm
B	0.25 mm	60 to 200 mm
C	0.5 mm	60 to 270 mm
D	1.0 mm	70 to 330 mm

\*1 Distance from the end of the case.

## Reading angle performance

### ■ Pitch angle

In the following conditions, readable up to  $\alpha = 30^\circ$  on either side.

- Bar code: Resolution = 0.25 mm, CODE39 (9 digits), PCS = 0.9
- Reading distance: 110 mm from the case end
- Installation condition: Skew angle  $\beta = 15^\circ$ , tilt angle  $\gamma = 0^\circ$ , curvature  $R = \infty$

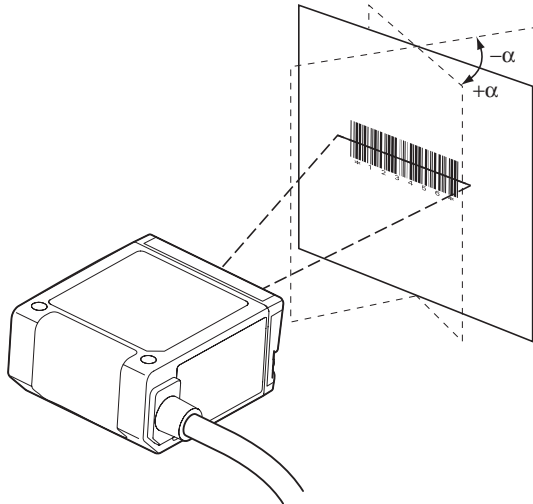

### ■ Skew angle

In the following conditions, readable up to  $\beta = \pm 60^\circ$ . However, range from  $\beta = -8^\circ$  to  $+10^\circ$  is an area difficult to read due to regular reflection.

- Bar code: Resolution = 0.25 mm, CODE39 (9 digits), PCS = 0.9
- Reading distance: 110 mm from the case end
- Installation condition: Pitch angle  $\alpha = 0^\circ$ , tilt angle  $\gamma = 0^\circ$ , curvature  $R = \infty$

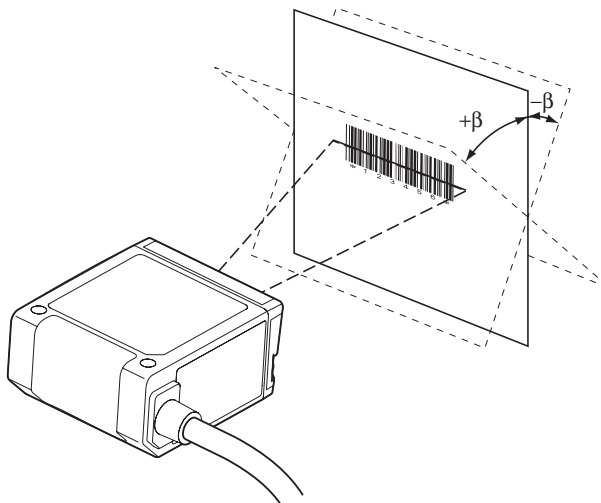

## ■ Tilt angle

Generally, a tilt angle is not specified, because it differs according to the bar code height.

Scan all the bar code with the laser.

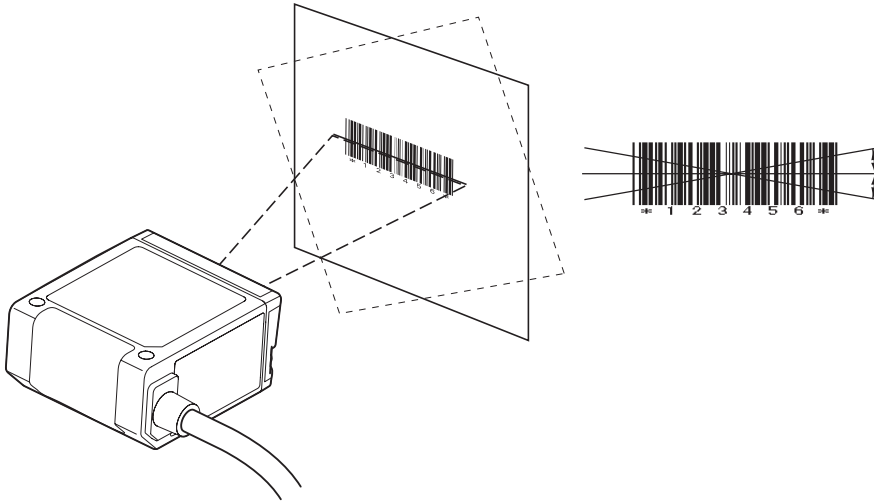

## ■ Curvature

In case of the following conditions, the bar code of 8-digit EAN, curvature range 15 mm or more and 13-digit EAN, curvature range 20 mm or more can be read.

- Bar code: Resolution = 0.26 mm, EAN, PCS = 0.9
- Reading distance: 110 mm from the case end
- Installation condition: Pitch angle  $\alpha = 0^\circ$ , skew angle  $\beta = 15^\circ$ , tilt angle  $\gamma = 0^\circ$

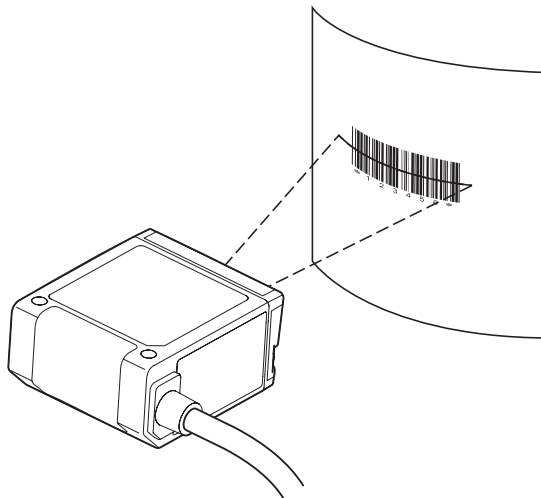

# Usage Flow Chart

Examination of the bar code beforehand, installation, and introduction flow chart is as shown below.

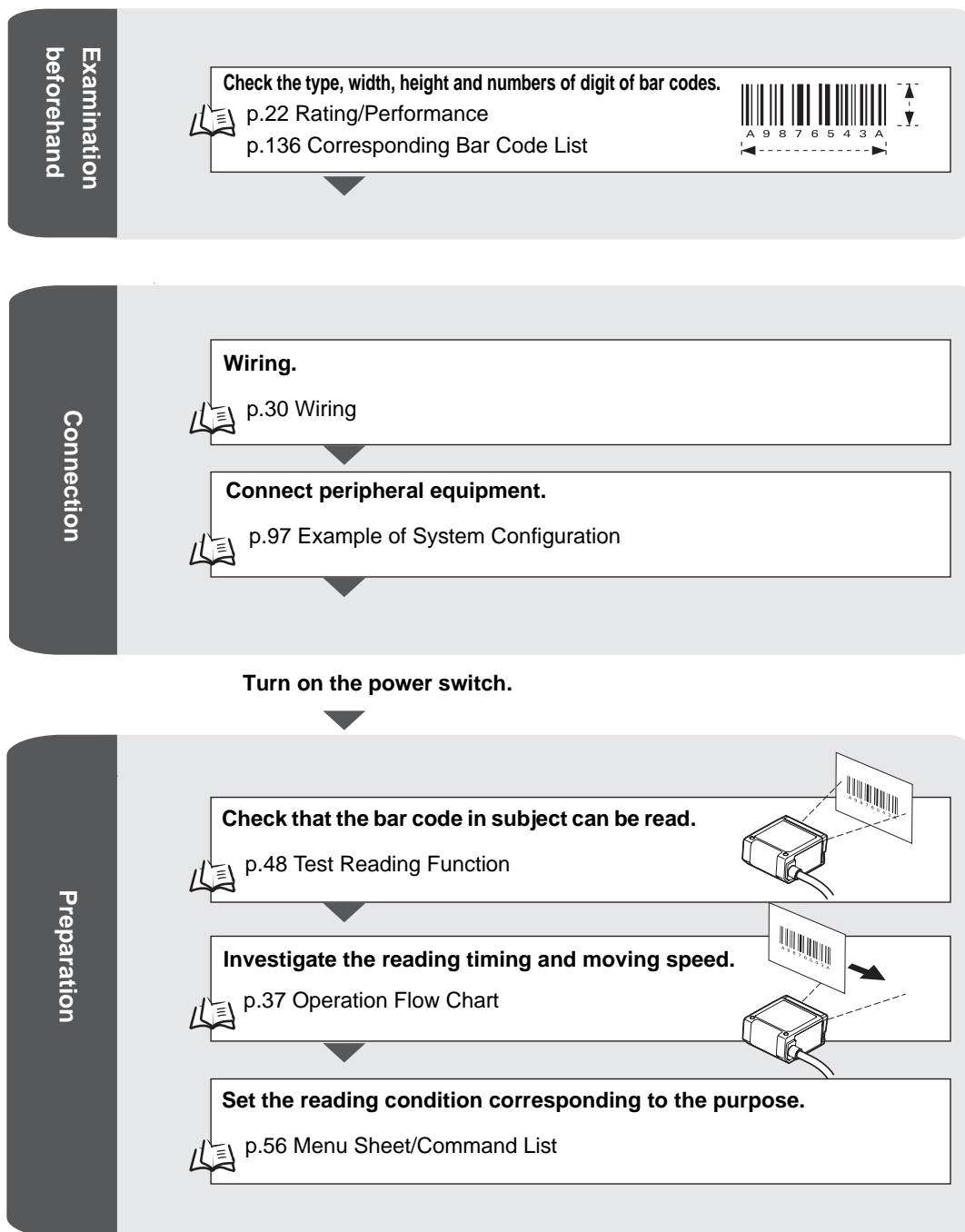

Installation -  
Execution of reading

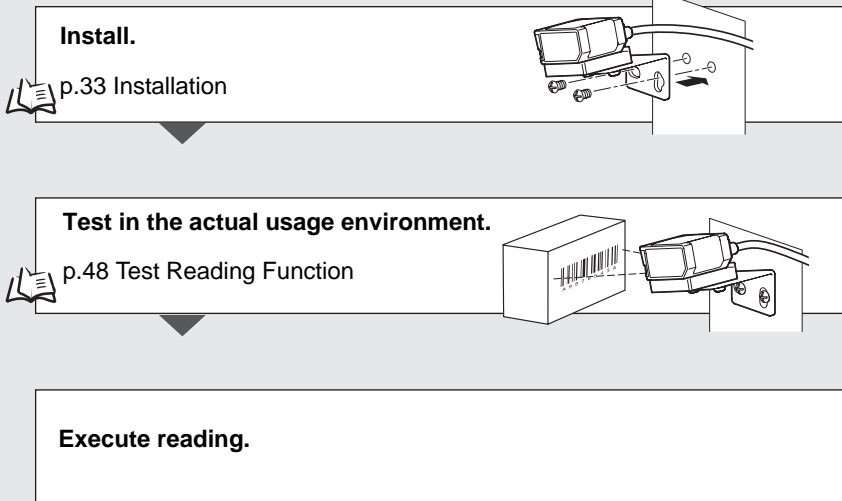

Applied way  
of using

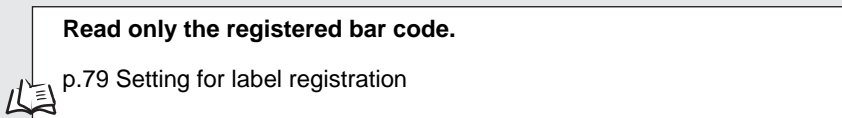

In case of trouble:

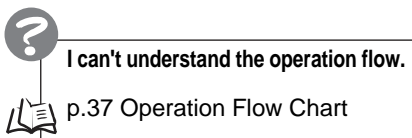
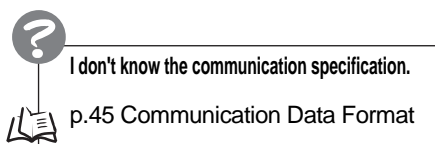
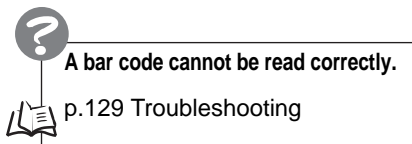

# Section 2

## Wiring and Installation

This section explains about the wiring method and installation method of the bar code reader.

 Wiring	30
 Installation	33

# Wiring



- Extension length of the RS-232C line (SD, RD, and SG) should be up to 15 m.
- Wiring should avoid approaching to a high-power heavy electric current wire.
- Turn off the power switch before connecting or disconnecting a connector.
- To assure noise and insulation resistance, be sure to use S8VS-01505 (made by OMRON) as a driving power supply.
- Do not connect a voltage or AC power supply that has a voltage exceeding the rating voltage (5 V +/-10%).
- Avoid reverse connection of power supply. Do not short circuit a load on OK/NG output signal (open collector).

## Wiring diagram

### ■ V500-R2 series

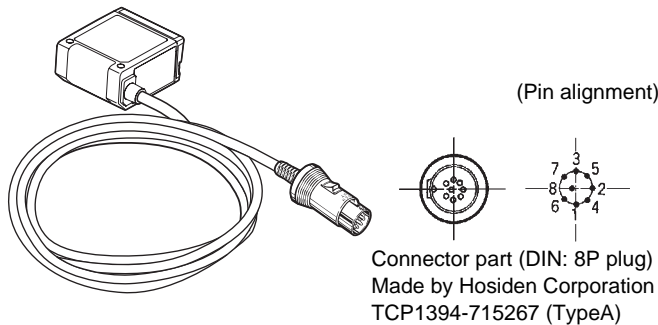

Wire color	Pin No.	Signal name	Function	Signal direction	
				Reader	Upper equipment
Green	1	SD	Transmission data	→	
White	2	RD	Received data	←	
Gray	3	RS	Transmission request	→	
Blue	4	CS	Transmission allowed	←	
Brown	5	TRIG	External trigger signal	←	
-	6	NC	Not connected		
Black	7	S.GND	0 V	←	External →
Red	8	VCC	Power supply	←	External →
Yellow	- (Note)	OK	READ OK output		External →
Orange	- (Note)	NG	READ NG output		External →

Connection with upper equipment p.98, p.99



The OK and NG output lines are not connected to the DIN 8-pin connector. To use the OK and NG outputs, cut the cables.



When you make a connection cable, use the following connectors.

Recommended parts for the connector

Usage	Manufacturer	Model
For cable relay	Hosiden Corporation	TCS8587-0170477
For panel installation 2	Hosiden Corporation	TCS1080-0120177



Logic of external trigger signal can be selected.

Positive logic (HIGH active)	Trigger ON 
Negative logic (LOW active)	Trigger ON 

Setting method p.57

You can select the output logic of READ OK and READ NG signal.

## Power supply

Recommended parts for the power supply

Manufacturer	Model
OMRON Corporation	S8VS-01505

## Input/output circuit

### Input circuit for the external trigger signal (V500-R2 series)

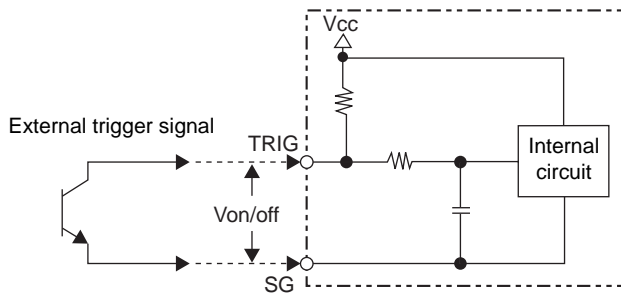

Item	Minimum value	Maximum value
Terminal voltage $V_{on}$ when a transistor is turned on	0 V	0.8 V
Terminal voltage $V_{off}$ when a transistor is turned off	2.0 V	3.3 V

■ READ OK/NG signal output circuit

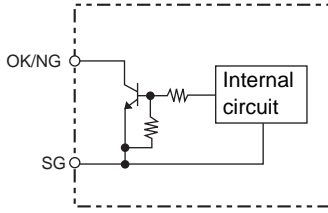

Item	Specification
Output system	NPN open collector
Rated load	24 VDC 30 mA
Leak current at OFF	0.5 mA or less
Residual voltage at ON	1 V or less

**Cable specification**

- Shape: Straight cable
- Diameter:  $\phi 3.8$  mm
- Length:  $1500 \pm 50$  mm
- Number of core: 9

# Installation

To avoid regular reflection of laser, incline approx. 15° against the bar code subject to read when installing the bar code reader. Use this mounting bracket as the mounting surface of an associated mounting bracket is inclined 15°.

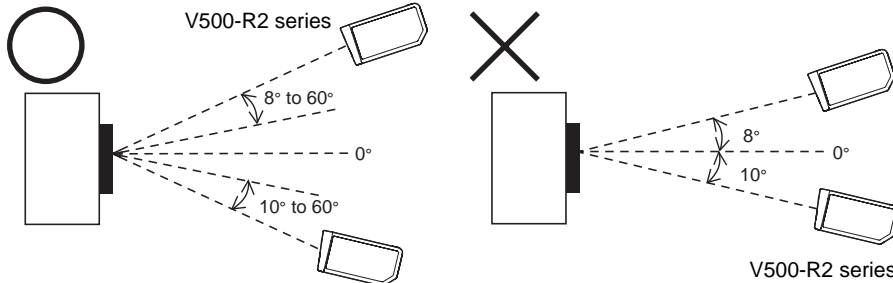

1. Attach the insulating plate and mounting bracket to the barcode reader. (M3 screws, Tightening torque 0.54 N•m)

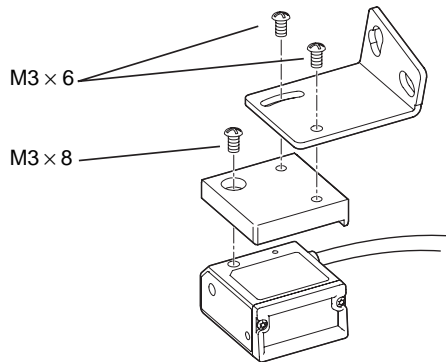

2. Install. (M5 screws, Tightening torque 2.3 N•m)

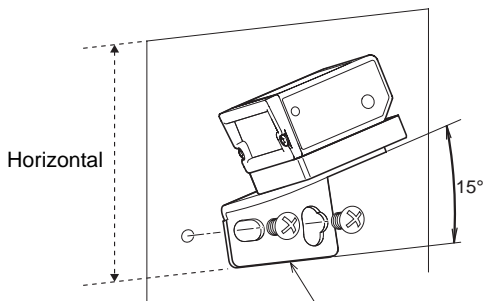

When you attach this line of the bracket horizontally, the bar code reader inclines 15°.

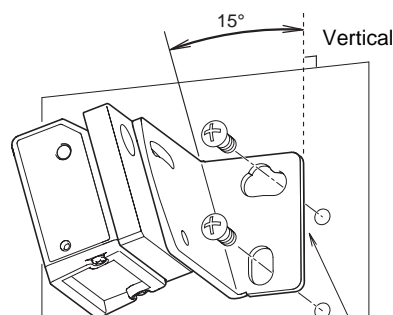

When you attach this line of the bracket vertically, the bar code reader inclines 15°.







- Do not apply stress on the cable when installing or using.
- Distance and angle allowed to read differs according the bar code. Check if the used bar code can be read actually, before installing.

MEMO

# Section 3

## Function Explanation

This section explains about representative functions of the bar code reader.

 Explanation of Reading System	36
 Operation Flow Chart	37
 Communication Data Format	45
 Test Reading Function	48

# Explanation of Reading System

There are following reading systems for this bar code reader.

 Setting method p.69

Reading system		Trigger reading	Full-time reading
		Reading starts by applying reading trigger from outside. This system is mainly used when operation.	During the power is turned on, laser is radiated all the time, to be able to read any time. This system is mainly used at installation and system testing.
Trigger Input method	External trigger signal	When the external trigger signal is turned on, laser radiates and starts reading. The "Trigger controlled system" reads during the trigger is ON, and the "Effective duration designation system" reads only the effective duration (*1) which is set beforehand after the trigger is ON.	– (Ignored even when input.)
	RS-232C command	The upper equipment sends the communication command and the laser beam radiates to start reading. After receiving the command, it reads only for the effective duration (*1) which is set beforehand.	– (Ignored even when input.)
	SCAN button (Back side)	Press the SCAN button once to read once. Handy to use to check if the reading condition setting is appropriate.	– (Ignored even when pressed.)
Reading operation	Single reading	When the reading succeeds, the data is output and ends reading automatically.	Reads continuously and outputs the data continuously.
	Plural reading	Reads bar codes continuously during the trigger is ON or effective duration (*1). When the first reading is completed, data is once output and while reading the same bar codes continuously, no output is made. Outputs newly only when the data differ from the adjacent bar code.	The bar code reading continues in series. While reading the same bar code, output is not newly made. Outputs newly only when the data differ from the adjacent bar code.
	Continuous reading	Reads bar codes continuously during the trigger is ON or effective duration (*1). Outputs data continuously even for the same bar code.	Reads continuously and outputs the data continuously.

\*1 Effective duration of reading

When the trigger input method is external trigger signal effective duration designation system or RS-232C command, effective duration setting is required beforehand.

 Effective duration setting method p.75

# Operation Flow Chart

## Basic operation flow chart

This clause explains steps of "Power on > Reading > Data output" in case of trigger reading.

■ In case of single reading

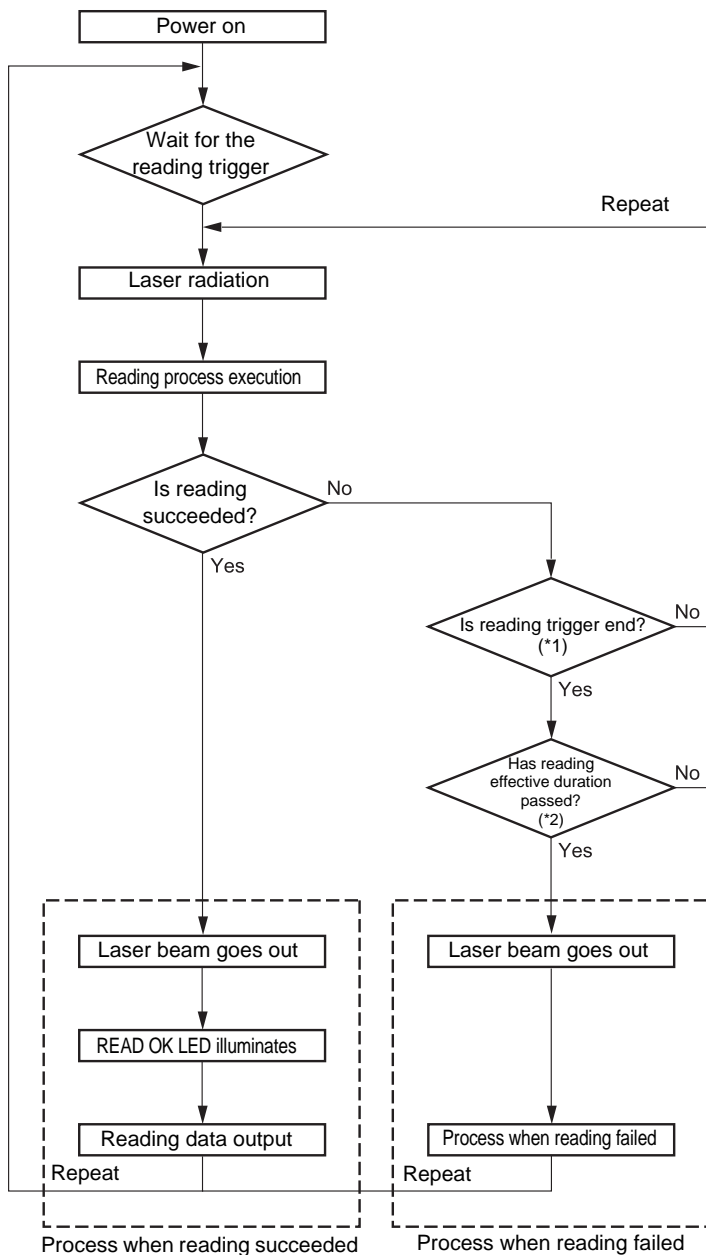

\*1 When the trigger by a command is used, ignore this clause.

\*2 In case of trigger controlled system (reads while the trigger is ON), consider that the reading effective duration is set to 0.

■ In case of plural reading

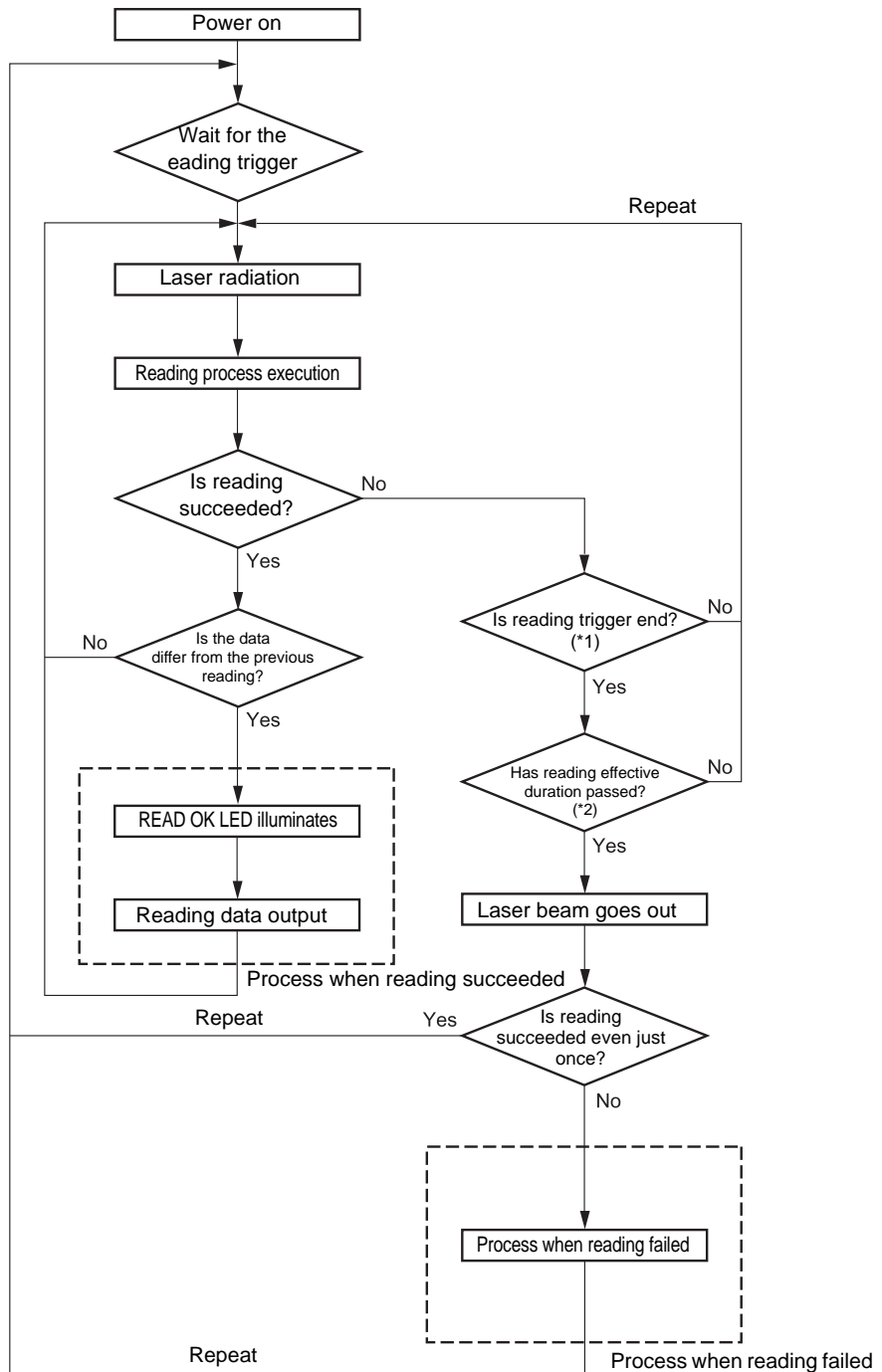

\*1 When the trigger by a command is used, ignore this clause.

\*2 In case of trigger controlled system (reads while the trigger is ON), consider that the reading effective duration is set to 0.



■ In case of continuous reading

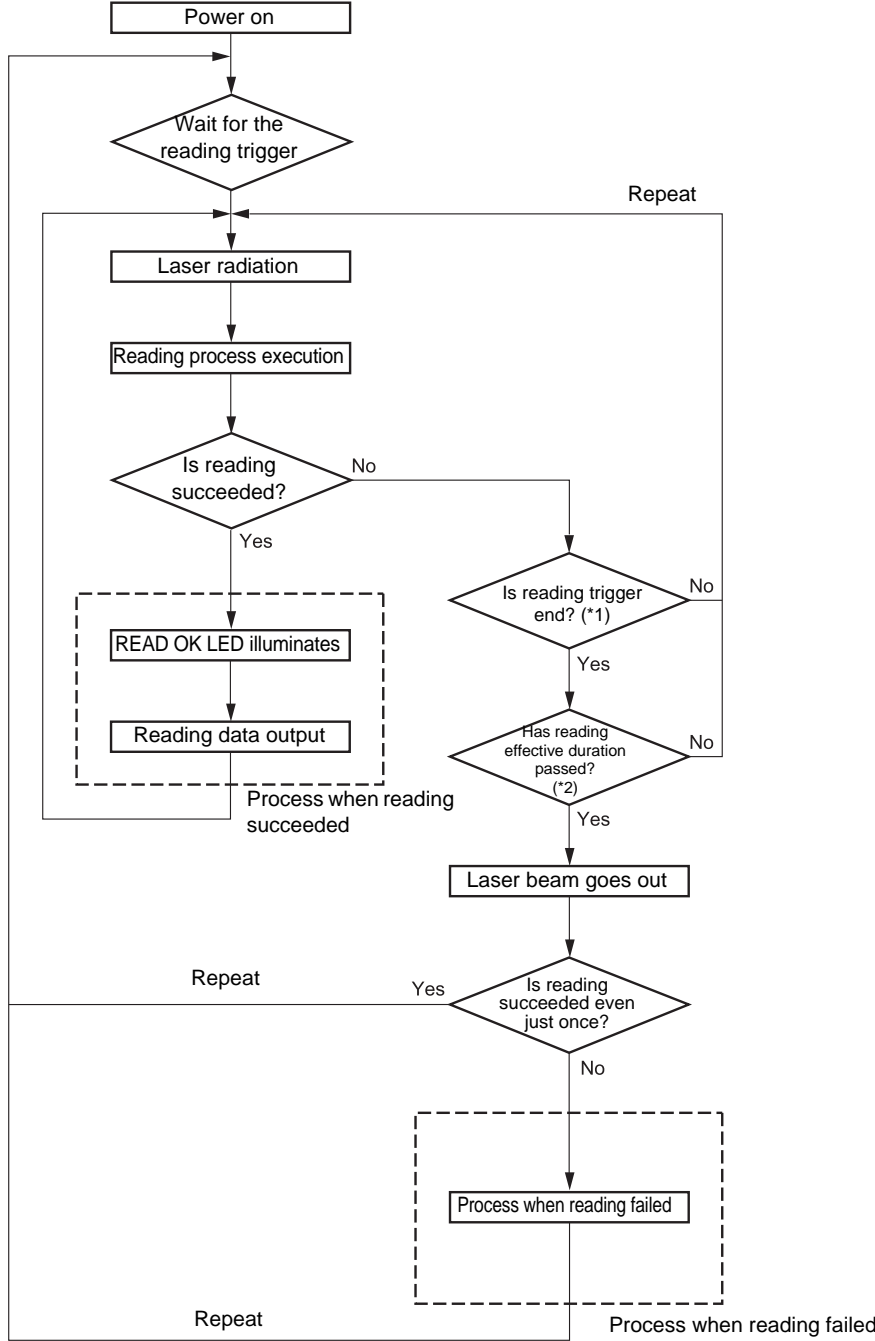

\*1 When the trigger by a command is used, ignore this clause.  
 \*2 In case of trigger controlled system (reads while the trigger is ON), consider that the reading effective duration is set to 0.

## Communication protocol

There are following two types of system to transmit the data read by the bar code reader to the upper equipment.

### ■ Nonprocedural system (no protocol system)

The bar code reader transmits the data to the upper equipment and ends.

Bar code reader  
V500-R2 series

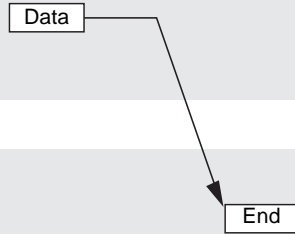
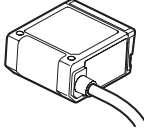

Upper equipment



### ■ ACK/NAK system

This bar code reader waits for the upper equipment response after transmitting the data. When ACK (06H) 1 byte is received from the upper equipment, buzzer sounds indicating the normal finishing and ends data transmission.

Bar code reader  
V500-R2 series

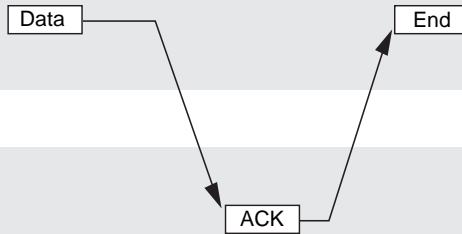
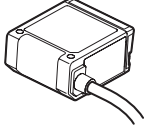

Upper equipment



When NAK (15H) 1 byte is received from the upper equipment data is transmitted again. When the time-up time comes which is set beforehand, the time-up buzzer sounds and the data transmission ends.

Bar code reader  
V500-R2 series

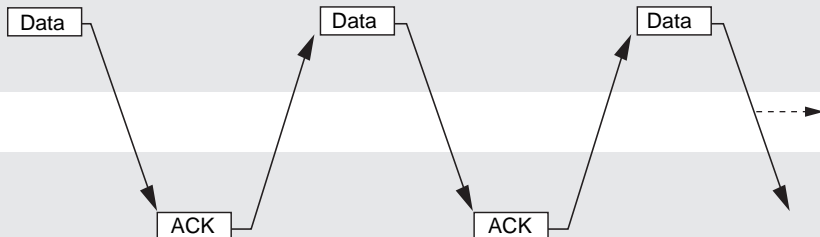
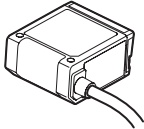

Upper equipment



# Communication timing chart

This section explains the indication timing of the buzzer and LED indication.

## In case when reading OK (single reading)

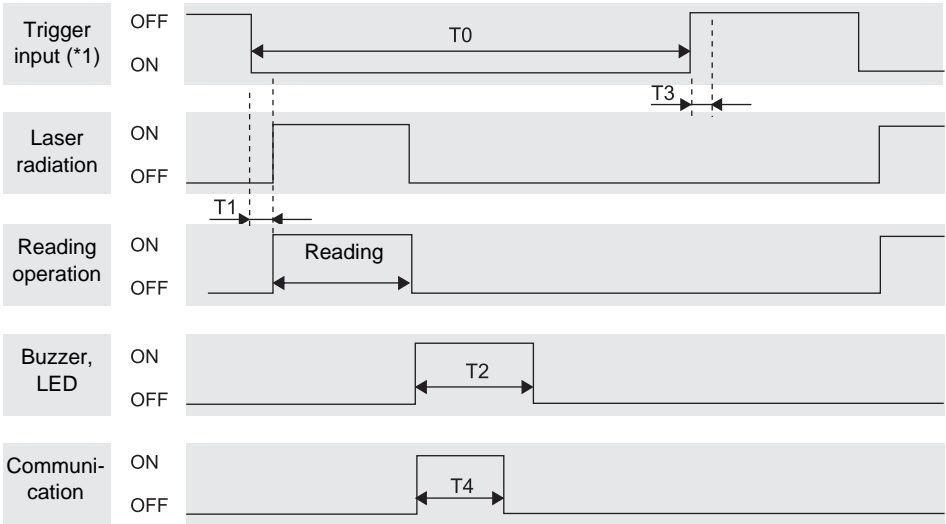

\*1 You can change the setting for the trigger input logic.

p.53

Time	Description
T0	Trigger ON time. (When effective duration is designated, consider it as effective duration.)
T1	Chattering prevention time. (5 ms)
T2	Buzzer and indication LED illumination time. (Initial value: 200 ms, changing allowed)
T3	Trigger signal minimum OFF time. Be sure to set 30 ms or more.
T4	Communication time. Differs according to communication condition.



- In case of continuous reading and plural reading, laser is always radiating during trigger input is ON (or during reading effective duration). Concept of T0 to T4 other than this is the same as the case of single reading.
- A rough guide of reading time  
As this bar code reader is approx. 1000 decode/sec., decode process time for once is 1 ms. In case of plural time conformance, "1 ms x (conformance time + 1)". However, it differs according to the reading bar code condition (dirt or thin spot, etc.)
- Concept of communication time

$$\text{Communication time (ms)} = \frac{(\text{Data length}) + (1: \text{In case when parity exists}) + (\text{Number of stop bit})}{(\text{Communication speed})} \times (\text{Number of digit of transmission data} + \text{Number of header characters} + \text{Number of footer characters}) \times 10^3$$

■ In case when reading NG (single reading)

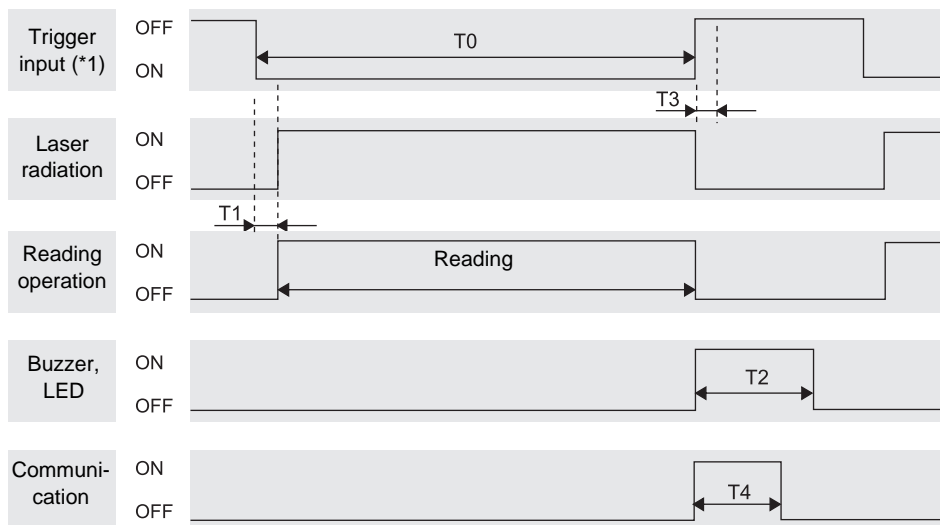

\*1 You can change the setting for the trigger input logic.

p.57

Time	Description
T0	Trigger ON time. (When effective duration is designated, consider it as effective duration.)
T1	Chattering prevention time (5 ms)
T2	Buzzer and indication LED illumination time. (Initial value: 200 ms, changing allowed)
T3	Trigger signal minimum OFF time. Be sure to set 30 ms or more.
T4	Communication time. Differs according to communication condition.



- In case of continuous reading and plural reading, laser is always radiating during trigger input is ON (or during reading effective duration). Concept of T0 to T4 other than this is the same as the case of single reading.

CHECK!

- Concept of communication time

$$\text{Communication time (ms)} = \frac{(\text{Data length}) + (1: \text{In case when parity exists}) + (\text{Number of stop bit})}{(\text{Communication speed})} \times (\text{Number of digit of transmission data} + \text{Number of header characters} + \text{Number of footer characters}) \times 10^3$$

### Concept of moving direction/line speed

When reading a moving bar code, fully investigate from the following viewpoint.

#### Confirmation of the timing chart

Duration from the reading trigger and outputting the data of actual reading differs according to condition.

 Operation Flow Chart p.37

#### Confirmation of trigger input timing

When constructing the system to read the moving bar code, input timing of the external trigger signal is important. Input the external trigger signal allowing enough timing considering the moving speed (moving distance) of the bar code.

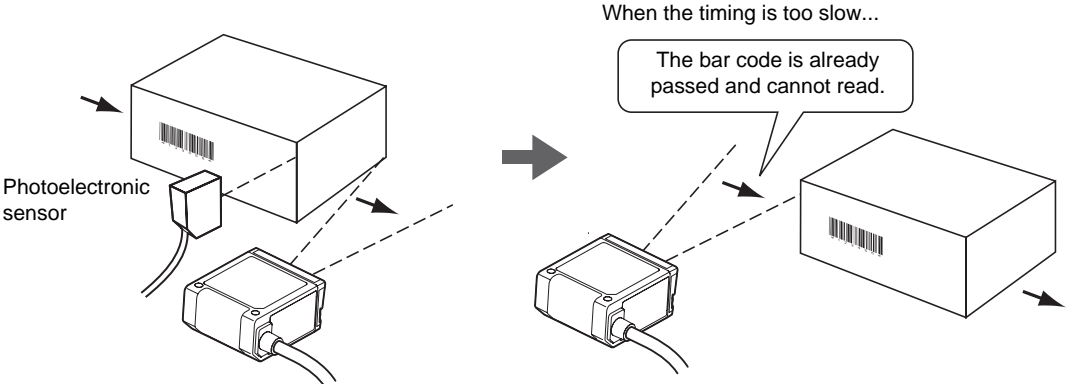

#### Checking the tack timing

In case when bar codes come continuously, calculate how close the bar codes may come, considering above two points.

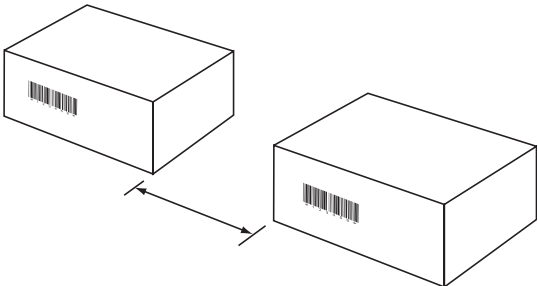



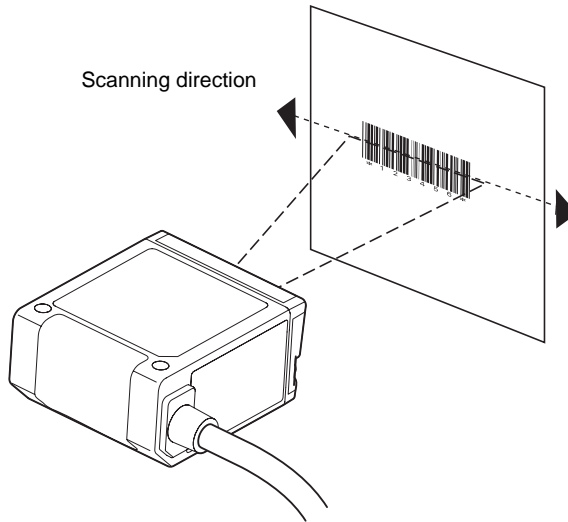

■ **Moving direction of a bar code**

Stability of reading differs according to the moving direction against the scanning direction.

As the appropriate direction differs according to the size of a label, investigate when installing.



Bar code moving direction	Scanning range
	 <p data-bbox="960 1091 1221 1207">Whole height of a bar code is scanned. In case of tall size label, this direction is stable.</p>
	 <p data-bbox="1042 1342 1221 1516">A part of the height of a bar code is scanned. In case of short size label, this direction is stable.</p>

# Communication Data Format

This section explains about communication data format of the bar code reader and the upper equipment.

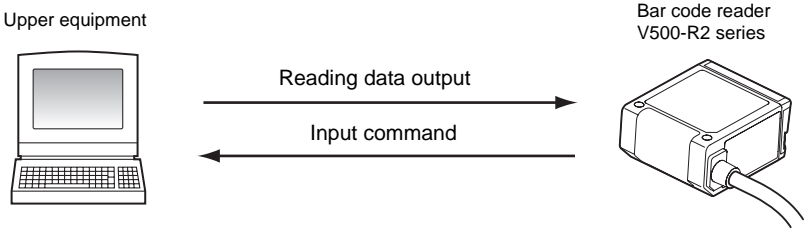

## Reading trigger input by RS-232C command

Reading trigger command format is as shown below.

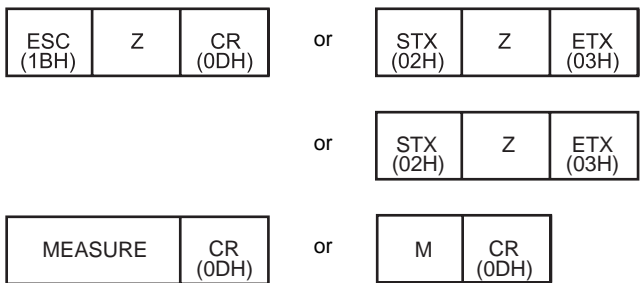

## Set command input

Reading condition set command can be transmitted from the upper equipment. Format is as follows.

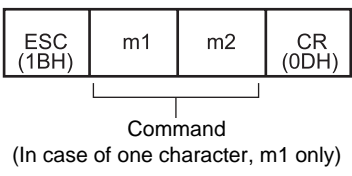

For details of command, refer to Section 4.

p.56

## Data output format when reading succeeded

When bar code reading is succeeded, following data is transmitted to the upper equipment.

Header	Number	Data of read bar code	Footer
--------	--------	-----------------------	--------

Output item	Description	Initial setting
Header	Letter strings to add at the head of transmitted data. Max 4 arbitrary characters can be set.	No header
Number of digit	Number of digit of the read data is output in two-digit ASCII code. Whether or not to output the number of digit is selectable.	No number of digit output
Footer	Letter strings to add at the end of transmitted data. Max 4 arbitrary characters can be set.	CR (0DH)

 Setting methods of whether to output header, number of digit and footer p.83

Note: If a read trigger is input by a MEASURE command or an abbreviated form of one of these commands, OK+CR(ODH) is returned before the data output format.

## Process when reading failed

Output format differs according to what is set to "reading failed process".

Selection of output format when reading failed	Remarks
No process	Nothing is transmitted
BR [CR] is transferred	—
[STX]?[ETX], [STX]>[ETX] is transferred	?: When it is judged as no bar code
?[CR], >[CR] are transferred	>: In cases other than above
[CAN] [CR] are transferred	—
[STX] [CAN] [ETX] are transferred	—

 Setting method p.73



## Data transfer contents of each reading code type

Reading code	Description
UPC-A	You can select whether or not to transfer the head character "0" for transfer digit number adjustment and check digit C/D. ("0" is the additional character combining with C/D to adjust the number of digit to be in accordance with EAN-13.) 0 S X1 X2 X3 X4 X5 X6 X7 X8 X9 X10 C/D S: Number system character (Automatically decided according to the combination of each character of X1 to X10.)
UPC-E	You can select whether or not to transfer the head character "0" for transfer digit number adjustment and check digit C/D. ("0" is the additional character combining with C/D to adjust the number of digit to be in accordance with EAN-13.) 0 S X1 X2 X3 X4 X5 X6 C/D S: Number system character (Automatically decided according to the combination of each character of X1 to X10.)
EAN	Reading data (8-digit or 13-digit) is transferred as it is.
ITF, Industrial 2 of 5(STF)	Transfers in the order from the next character of the start code to the character before the stop code. (Start code and stop code are not transferred.)
Codabar(NW-7), CODE39	You can select whether or not to transfer the start code and stop code. When the start code and stop code is permitted to transfer, you can select whether the transferred start/stop code of Codabar(NW-7) is in lower-case "a/b/c/d" or in upper-case "A/B/C/D". Transfer start/stop code of CODE39 is "***".
GS1-128(EAN128)	Add a control character "C1" (ASCII code 5D, 43, 31) which indicates GS1-128, at the head of the transfer data. Also, FNC1 character, as a separating character, is replaced to GS (ASCII code 1DH) character and transferred.

 Setting method p.64

# Test Reading Function

You can check how stably the subject bar code can be read.

Read a bar code at resting state for one sec. and calculate the reading rate.

## ■ To enter reading measurement mode using a command

1. Install the bar code at a reading position.

2. Enter command ".V".

Mode enters to reading rate measurement mode.

Reading rate of every one sec. is measured.

3. To finish the reading rate measurement mode, enter command ".W" or re-start the bar code reader.

Return to the normal measurement mode.



Do not execute write command "Z2" to nonvolatile memory.

A sample setting condition is overwritten and stored, which erases the already set reading condition.

CHECK!

## ■ Output format

Reading rate of every one sec. is output to the upper equipment, while in reading rate measurement mode.

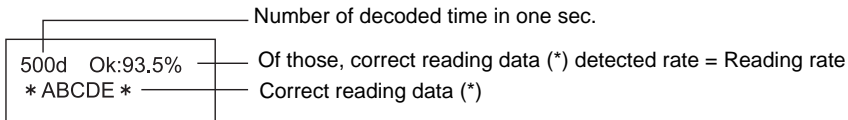





Data, which detected most during measurement mode, is "correct reading data".

Communication data format



ESC	[ 3 A	CR	500d	SPACE	Ok:	93.5%	CR	*ABCDE*	CR
-----	-------	----	------	-------	-----	-------	----	---------	----

■ **A rough guide of reading rate**

The LED illumination patten on the back side changes according to the result of reading rate.

Reading rate	READ OK LED	Description
76~100 %		Reading is possible without problem.
51~75 %		When the bar code is at still state when read, reading is possible without problem. However, when the target bar code is moving, reading may be failed according to speed.
26~50 %		There is a possibility to fail even reading at still state. Check if the installation location and angle of the bar code reader is appropriate once more.
0~25 %		Reading is not stable. Check if there is no dirt or lack on the bar code. Check if the installation location and angle of the bar code reader is appropriate once more.

**LED indication**

 : Lights out     
  : Blink     
  : Illuminate

MEMO

# Section 4

## Setting Method

This section explains about setting methods using a menu sheet and entering command from the upper equipment.

☒	How to Use Menu Sheet/Command	52
☒	Menu Sheet/Command List	56

# How to Use Menu Sheet/Command

There are following two setting methods for the bar code reader. Select either method according to the condition.

Setting method	Description
Read the menu sheet.	This method reads the menu sheet of the function you want to set. It is convenient for the initial setting and when testing.
Input a command from the upper equipment.	This method inputs a command from the upper equipment. It is convenient when changing setup according to the type of the bar code.

## Read the menu sheet

The menu sheet is a special bar code used to set this bar code function. Setting can be changed by reading this menu sheet.

1. Read "ZZ" of the menu sheet that means setting start/end.

Buzzer sounds continuously.

The bar code reader entered setting mode.



2. Read "U2" on the menu sheet that means to return to factory default setting.



3. Read the item on the menu sheet you want to change setting.

 Menu Sheet/Command List p.56

4. To finish setting, read "ZZ" on the menu sheet for setting start/end, again.

Buzzer sound stops and returns to normal mode.



## ■ How to create menu sheet

The used menu sheet is a code system of CODE39. However, the code is special, using start code and stop code for a space mark. (Normally "\*\*")

You can create a menu sheet using bar code creation software available in the market, as shown below.

E.g.: When creating a menu sheet "A3"

Create "\* A3 \*" and cut the parts of "\*\*" with scissors to create the menu sheet "A3".



## Input command from the upper equipment

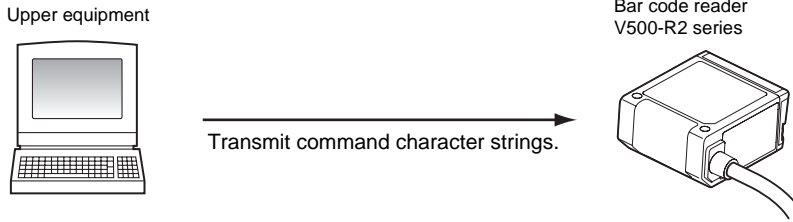

1. Transmit the command character strings of the function you want to set.

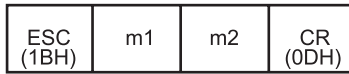

(In case of one character, m1 only)

 Menu Sheet/Command List p.56



During the bar code reader is processing command, it notifies externally that it is in processing mode turning off the RS signal line.

When the RS signal line is not connected, interval between inputting commands should be taken sufficiently.

2. Transmits "Z2", in order to write the set data on the nonvolatile memory in the bar code reader.



Be sure to write when a condition is set by inputting command from the upper equipment. When you turn off the power without writing the setting in the memory, the set content may be deleted.



Transmission method of the command by designating values and characters is explained as follows.

E.g. 1: Set "AB [CR]" on header. (When designating codes directly)

ESC (1BH)	R	Y	CR (0DH)	Transmit a header setting command.
ESC (1BH)	0	A	CR (0DH)	Transmit a character "A".
ESC (1BH)	0	B	CR (0DH)	Transmit a character "B".
ESC (1BH)	1	C	CR (0DH)	Transmit CR code.

E.g. 2: Set "AB [CR]" on header. (When designating hexadecimal number directly)

ESC (1BH)	R	Y	CR (0DH)	Transmit a header setting command.
#	4	1	CR (0DH)	Transmit 41 "A" in hexadecimal number.
#	4	2	CR (0DH)	Transmit 42 "B" in hexadecimal number.
ESC (1BH)	1	C	CR (0DH)	Transmit CR code.



"00H" (zero) cannot be designated as header or footer. It is regarded as end character.  
Characters until just before 00H are valid.

## Menu Sheet/Command List

Groups are classified as follows. Please refer to the corresponding pages.

Setting item	Reference
Start/end setting using menu sheets	p.57
Write setting contents on the nonvolatile memory	p.57
Setting for external trigger signal	p.57
Return to the factory default setting	p.58
Collective setting	p.60
Setting of reading permission and prohibition	p.62
Detail setting for reading code	p.64
Setting for the number of times of reading coincidence	p.69
Setting for reading operation	p.70
Setting for reading effective duration	p.70
Setting for plural reading reset time	p.72
Setting for failed reading	p.73
Setting for the number of reading digits	p.74
Setting for the READ OK LED	p.75
Setting for the buzzer	p.75
Setting for READ OK signal output	p.77
Setting for label registration	p.79
Setting for communication conditions	p.80
Setting for the communication protocol	p.82
Setting for the header and footer	p.83
Number of digit output	p.84
Direct code designation	p.85

## Start/end setting using menu sheets

When setting the reader using menu sheets, read this menu sheet at the start and end of the procedure.

Menu sheet	Command
Start/end setting using menu sheets 	None



## Write setting contents on the nonvolatile memory

Be sure to write the settings in the nonvolatile memory whenever a condition is set by inputting a command from the upper equipment. When you turn the power OFF without writing the setting in the memory, the settings will be lost.

Menu sheet	Command
Write the contents set with a command in the nonvolatile memory.  (No menu sheet)	Z2

## Setting for external trigger signal

Select positive logic or negative logic of the external trigger signal.

Menu sheet	Command
External trigger signal, positive logic (H active) 	YA
External trigger signal, negative logic (L active) (factory default setting) 	YB

## Return to the factory default setting

Menu sheet	Command
Return to the factory default setting 	U2

### Factory default setting

Item		Setting content
Readable code types		JAN/UPC (A and E)/EAN(13 and 8), CODE39, Codabar(NW-7), Industrial2of5, ITF, CODE128, CODE93, and GS1 DataBar (RSS) (composite is excluded)
Detail conditions	UPC/EAN detail settings	UPC-A: Transfer C/D without an 0 in the beginning
		UPC-E: Transfer C/D without an 0 in the beginning
		EAN-13: Transfer C/D
		EAN-8: Transfer C/D
	CODE39 detail settings	Not calculate C/D
		Transfer C/D
		Not transfer ST/SP
	Codabar (NW-7) detail settings	Not calculate C/D
		Transfer C/D
		Not transfer ST/SP
Industrial2of5(STF) detail settings	Data character of at least 5 digits	
	Not calculate C/D	
	Transfer C/D	
GS1-Databar(RSS) detail settings	Transfer C/D	
GS1-128(EAN128) detail settings	Disable FNC1 to GS conversion	
Reading conditions	Reading method (normal reading / trigger reading)	Trigger reading
	Number of reading verification times	Once
	Reading operation	Single reading
	Failed reading	Transmit nothing
	Number of reading digits	Not specified
	Reading valid time	2 seconds
	Plural reading reset time	6 frames
LED	READ OK LED illumination time: 200 ms	
Buzzer	Enable the buzzer	
	Single-tone buzzer	
	Buzzer sound duration: 50 ms	
	Buzzer sound volume: Max	

Item		Setting content
External trigger signal		Negative logic (L active)
READ OK/NG signal output	Signal output	Output signals
	Signal output system	External trigger synchronous system (positive logic, H active)
Label registration		None
Communication conditions	Communication speed	9600 bps
	Data length	8 bits
	Parity	None
	Stop bit	1 bit
	Header	None
	Footer	CR
	Number of digit output	None
	RS/CS control	None (no protocol system)
	CS waiting time	Not limited
	ACK/NAK waiting time	Not limited

## Collective setting

Collective setting of conditions appropriate for connection of programmable controller (EDB) and for connection of multi-drop using link unit (EDA) is allowed.

Menu sheet	Command
Setting of programmable controller connection 	[EDB]

Hatching parts are the changed point from the factory default setting.

### Collective setting

Item	Setting content	
Types of code, which is possible to read	EAN/UPC, CODE39, Codabar (NW-7), Industrial2of5(STF), ITF	
Number of reading digits	No designated number of digits	
Detail condition	CODE39 detail setting	Invalid C/D of CODE39 Transfer C/D of CODE39 Transfer ST/SP of CODE39
	Codabar (NW-7) detail setting	Invalid C/D of Codabar (NW-7) Transfer C/D of Codabar (NW-7) Transfer ST/SP of Codabar (NW-7) (abcd/abcd)
	ITF/Industrial2of5(STF) detail setting	Invalid C/D of ITF/Industrial2of5(STF) Transfer C/D of ITF/Industrial2of5(STF)
	Reading system	Trigger reading
	Reading operation	Single reading
	Reading valid time	Trigger + 2 sec.
Number of reading coincidence	Twice (Verification: once)	
Communication condition	Communication speed	9600 bps
	Data length	7-bit
	Parity	Even number
	Stop bit length	2-bit
	Header	None
	Footer	CR
	Transfer number of digits	Not transferred
	RS/CS control	None
	CS waiting time	Infinity
	Communication protocol	No protocol system
Process when reading is NG	Transfer ? (CR), > (CR)	
LED illumination	LED illumination time after decoding is 200 ms.	
Buzzer sound	Buzzer sound duration after decoding is 200 ms.	
Buzzer sound volume	Max.	
Buzzer frequency	3 kHz, 2 kHz	
External trigger signal	Negative logic (L active)	
READ OK/NG signal output	Output	
READ OK/NG signal output system	Trigger synchronous system, positive logic (H active)	

Menu sheet	Command
Setting for connecting link unit (V700-L12)  E D A	[EDA]

Hatching parts are the changed point from the factory default setting.











### Collective setting

Item		Setting content
Types of code, which is possible to read		EAN/UPC, CODE39, Codabar (NW-7), Industrial2of5(STF), ITF
Number of reading digits		No designated number of digits
Detail condition	CODE39 detail setting	Invalid C/D of CODE39
		Transfer C/D of CODE39
		Transfer ST/SP of CODE39
	Codabar (NW-7) detail setting	Invalid C/D of Codabar (NW-7)
		Transfer C/D of Codabar (NW-7)
		Transfer ST/SP of Codabar (NW-7) (abcd/abcd)
ITF/Industrial2of5(STF) detail setting	Invalid C/D of ITF/Industrial2of5(STF)	
	Transfer C/D of ITF/Industrial2of5(STF)	
Reading condition	Reading system	Trigger reading
	Reading operation	Single reading
	Reading valid time	Trigger + 2 sec.
	Number of reading coincidence	Twice (Verification: once)
Communication condition	Communication speed	9600 bps
	Data length	8-bit
	Parity	Even number
	Stop bit length	1-bit
	Header	None
	Footer	CR
	Transfer number of digits	Not transferred
	RS/CS control	None
	CS waiting time	Infinity
	Communication protocol	No protocol system
	Process when reading is NG	Transfer ? (CR), > (CR)
LED illumination	LED illumination time after decoding is 200 ms.	
Buzzer sound	Buzzer sound duration after decoding is 200 ms.	
Buzzer sound volume	Max.	
Buzzer frequency	3 kHz, 2 kHz	
External trigger signal	Negative logic (L active)	
READ OK/NG signal output	Output	
READ OK/NG signal output system	Trigger synchronous system, positive logic (H active)	

## Setting of reading permission and prohibition

Select the types of code to be read.

For higher reading reliability, prohibit reading of codes that will not be read.

Menu sheet	Command
All codes except add-ons (Factory default setting) 	A0
Reading prohibition for all codes 	B0
Reading permission for UPC codes 	R1
Permission for UPC add-on 2-digit codes 	R2
Permission for UPC add-on 5-digit codes 	R3
Reading permission for JAN/EAN codes 	R4
Permission for EAN add-on 2-digit codes 	R5
Permission for EAN add-on 5-digit codes 	R6
Reading permission for CODE39 codes 	B2
Reading permission for Cadabar(NW-7) codes 	B3







Menu sheet	Command
Reading permission for Industrial2of5(STF) codes 	R7
Reading permission for ITF codes 	R8
Reading permission for CODE128 codes 	B6
Reading permission for CODE93 codes 	B5
Reading permission for GS1 DataBar(RSS-14) codes 	JX
Reading permission for GS1 DataBar(RSS-Limited) codes 	JY
Reading permission for GS1 DataBar(RSS-Expanded) codes 	DR





## Detail setting for reading code

Conditions for details about reading codes, such as whether to use the check digit (C/D) or to transmit the start code/stop code (ST/SP), are set.



### UPC-A

Menu sheet	Command
Transfer C/D without an 0 in the beginning (Factory default setting) 	E3
Not transfer C/D without an 0 in the beginning 	E5
Transfer C/D with 0 in the beginning 	E2
Not transfer C/D with 0 in the beginning 	E4



### UPC-E

Menu sheet	Command
Transfer C/D without an 0 in the beginning (Factory default setting) 	E7
Not transfer C/D without an 0 in the beginning 	E9
Transfer C/D with 0 in the beginning 	E6
Not transfer C/D with 0 in the beginning 	E8





EAN-13

Menu sheet	Command
Transfer C/D (Factory default setting) 	6K
Not transfer C/D 	6J

EAN-8









Menu sheet	Command
Transfer C/D (Factory default setting) 	6I
Not transfer C/D 	6H





CODE39

Menu sheet	Command
Not calculate C/D (Factory default setting) 	C1
Calculate C/D 	C0
Transfer C/D (Factory default setting) 	D9
Not transfer C/D 	D8
Transfer ST/SP 	D0

Menu sheet	Command
Not transfer ST/SP (Factory default setting) 	D1

**Codabar(NW-7)**

Menu sheet	Command
Not calculate C/D (Factory default setting) 	H7
Calculate C/D 	H6
Transfer C/D (Factory default setting) 	H8
Not transfer C/D 	H9
Not transfer ST/SP (Factory default setting) 	F0
ST/SP: ABCD/ABCD 	F3
ST/SP: abcd/abcd 	F4
ST/SP: ABCD/TN*E 	F1
ST/SP: abcd/tn*e 	F2



Menu sheet	Command
ST/SP: <DC1><DC2><DC3><DC4>/<DC1><DC2><DC3><DC4>  H J	HJ
Data character of at least 1 digit  H C	HC
Data character of at least 3 digits  H B	HB
Data character of at least 5 digits  H F	HF

**Industrial2of5(STF)**



Menu sheet	Command
Not calculate C/D (Factory default setting)  G 0	G0
Calculate C/D  G 1	G1
Transfer C/D (Factory default setting)  E 0	E0
Not transfer C/D  E 1	E1
Data character of at least 1 digit  G E	GE
Data character of at least 3 digits  G F	GF

Menu sheet	Command
Data character of at least 5 digits 	GI

**GS1-128(EAN-128)**

Menu sheet	Command
Disable GS1 conversion (Factory default setting) 	[X/0
Enable GS1 conversion 	[X/4

**GS1-Databar(RSS) Menu sheet**

Menu sheet	Command
Not transfer C/D 	DM
Transfer C/D 	DL

## Setting for the number of times of reading coincidence



When reading result coincides the number of times you have set, the reading result is output to the RS-232C interface.

The verification system is AND verification (Continuous coincidence system). (This cannot be changed.)



Menu sheet	Command
Reading once and verification zero times  X 0	X0
Reading twice and verification once (Factory default setting)  X 1	X1
Reading three times and verification twice  X 2	X2
Reading four times and verification three times  X 3	X3
Reading five times and verification four times  B S	BS
Reading six times and verification five times  B T	BT

## Setting for reading operation

The reading operation is set.



Menu sheet	Command
Single reading (Factory default setting) 	S0
Plural reading 	S1
Continuous reading 	S2

### Reading method









Menu sheet	Command
Normal reading 	S7
trigger reading(Factory default setting) 	S8

## Setting for reading effective duration

The time during which the reading continues after a trigger is input is set. When it is set to 0 sec., reading is controlled by the external trigger and the trigger is effective while the external trigger is ON.

Menu sheet	Command
0 seconds (controlled by the external trigger) 	Y0
1 second 	Y1



Menu sheet	Command
2 seconds (Factory default setting) 	Y2
3 seconds 	Y3
4 seconds 	Y4
5 seconds 	Y5
6 seconds 	Y6
7 seconds 	Y7
8 seconds 	Y8
9 seconds 	Y9
Infinity 	YM

## Setting for plural reading reset time

This setting has effect when plural reading is enabled.

This setting specifies the number of frames (length of time) during which the reader should be kept away from the code before reading the same code again.









### Frames

A frame is another representation of time (ms). Intervals between frames are not constant and they differ depending on codes. When the frame is set to infinity, the next code must differ from the previous one as long as a trigger is input.

(Example)

Frame	1	2	3	4	5	6
Time (ms)	50	100	200	300	400	500

Menu sheet	Command
1 frame 	AH
2 frames 	AI
3 frames 	AJ
4 frames 	AK
5 frames 	AL
6 frames (Factory default setting) 	AM
Infinity 	AG

## Setting for failed reading

Process for failed reading is set.

With the factory default setting, nothing is transmitted in the event of failed reading.

### ■ Error message - No label

Direct input characters of up to 4 digits can be set. These characters are transmitted when no code (label) is detected during the reading time.



CHECK!

- The error message is disabled when no direct input characters are read after the command.
- This may be output simultaneously with "Error message - Decoding failure".

### ■ Error message - Decoding failure

Direct input characters of up to 4 digits can be read. These characters are transmitted when a code (label) is detected during the reading time but nothing is read.



CHECK!

- The error message is disabled when no direct input characters are read after the command.
- This may be output simultaneously with "Error message - No label".

E.g.: In the following two examples, the "NL<CR>" message is set for "No label" and the "ND<CR>" message for "Decoding failure". Those two examples may occur at the same time.

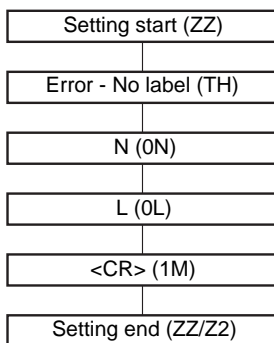

When no code is detected during the reading time

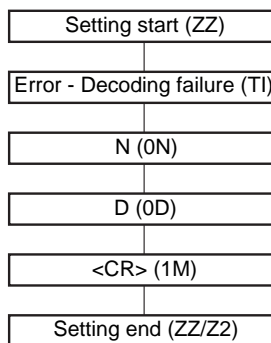

When a code is detected during the reading time but nothing is read



Menu sheet	Command
Error message - No label  T H	TH

Menu sheet	Command
Error message - Decoding failure 	TI
Not transmit an error message (Factory default setting) 	TG

## Setting for the number of reading digits

When the number of reading digits is fixed, all codes having other lengths than that specified can be rejected. Up to two reading digits can be set.

This setting is effective for codes such as Interleaved 2 of 5 for which security against partial reading is insufficient.



While the number of reading digits to be fixed can be set by reading the code, the number of reading digits cannot be set with a command since a code of the necessary length must be read.



- To read codes of a known length, it is recommended that the number of digits be fixed.
- While the number of reading digits to be fixed can be set by reading the code, it is not affected by a detail setting (p.64) for reading codes, including "Transfer ST/SP", "Not transfer ST/SP", "Transfer C/D" and "Not transfer C/D".
- Fixing the number of reading digits does not affect WPC (JAN/EAN/UPC) or other fixed-length codes.

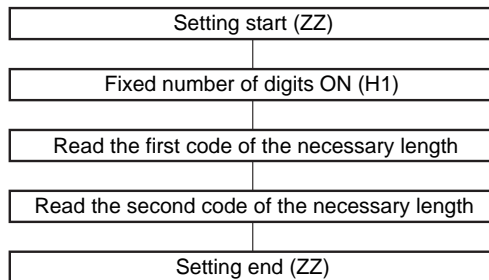



E.g.: The following describes the steps for fixing the number of reading digits.



Menu sheet	Command
Fixed number of digits OFF for all codes (Factory default setting) 	H0
Fixed number of digits ON for all codes 	None



## Setting for the READ OK LED











The READ OK LED is disabled or its illumination time is set. The READ OK LED illuminates when reading succeeds.

Menu sheet	Command
Disable the READ OK LED 	T4
READ OK LED illumination time: 200 ms (Factory default setting) 	T5
READ OK LED illumination time: 400 ms 	T6
READ OK LED illumination time: 800 ms 	T7

## Setting for the buzzer

The buzzer is enabled or disabled or its type and sound duration and volume are set. The buzzer sounds when reading succeeds.









Menu sheet	Command
Disable the buzzer 	W0
Enable the buzzer (Factory default setting) 	W8
Single-tone buzzer (Factory default setting) 	W1







Menu sheet	Command
High-low buzzer 	W2
High-high buzzer 	W3
Buzzer sound duration: 50 ms (Factory default setting) 	W7
Buzzer sound duration: 100 ms 	W4
Buzzer sound duration: 200 ms 	W5
Buzzer sound duration: 400 ms 	W6
Buzzer sound volume: Max (Factory default setting) 	T0
Buzzer sound volume: High 	T1
Buzzer sound volume: Medium 	T2
Buzzer sound volume: Low 	T3

## Setting for READ OK signal output

When you want to output reading succeeded to the READ OK signal, set the conditions of output system and duration, then set them for “signal output (X\*Q)”.

The READ NG signal is output when any code other than the labels registered in “Setting for label registration” (p.79) is read.

Menu sheet	Command
Output the signal (Factory default setting)  X * Q	[X*Q]
Not output the signal  X * R	[X*R]
External trigger signal synchronous system (positive logic, H active) (Factory default setting)  X * C	[X*C]
External trigger signal synchronous system (negative logic, L active)  X * D	[X*D]
One-shot system (positive logic, H active)  X * E	[X*E]
One-shot system (negative logic, L active)  X * F	[X*F]
One-shot duration: 10 ms  X * G	[X*G]
One-shot duration: 20 ms  X * H	[X*H]
One-shot duration: 30 ms  X * I	[X*I]

Menu sheet	Command
One-shot duration: 40 ms  X * J	[X*J]
One-shot duration: 50 ms  X * K	[X*K]
One-shot duration: 60 ms  X * L	[X*L]
One-shot duration: 70 ms  X * M	[X*M]
One-shot duration: 80 ms  X * N	[X*N]
One-shot duration: 90 ms  X * O	[X*O]
One-shot duration: 100 ms  X * P	[X*P]



## Setting for label registration

You should first register codes in the reader so that they are recognized as OK. This function outputs the OK signal when the reader reads a code that matches one of the registered codes and outputs the NG signal for a code that does not match any of those codes.

Up to 5 codes can be registered.



Up to 123 bytes of a single set of data, and up to 250 bytes of data in total can be registered.

CHECK!

E.g.: The following describes the steps for registering labels.

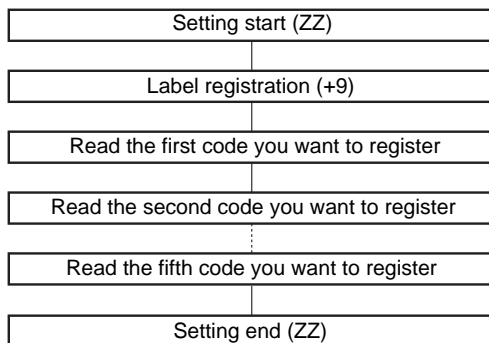

















Menu sheet	Command
Register labels 	+9

To cancel a label registration, end the setting without reading a label in label registration processing.





## Setting for communication conditions

The settings made here are not fixed until the menu sheet “ZZ” for ending setting is read or the setting save command “Z2” is transmitted and the reader is restarted.

Menu sheet	Command
Communication speed: 300 bps 	K1
Communication speed: 600 bps 	K2
Communication speed: 1200 bps 	K3
Communication speed: 2400 bps 	K4
Communication speed: 4800 bps 	K5
Communication speed: 9600 bps (Factory default setting) 	K6
Communication speed: 19200 bps 	K7
Communication speed: 38400 bps 	K8
Communication speed: 57600 bps 	K9
Communication speed: 115200 bps 	SZ

Menu sheet	Command
Data length: 7 bits 	L0
Data length: 8 bits (Factory default setting) 	L1
Parity: None (Factory default setting) 	L2
Parity: Even number 	L3
Parity: Odd number 	L4
Stop bit: 1 bit (Factory default setting) 	L5
Stop bit: 2 bits 	L6

## Setting for the communication protocol

Menu sheet	Command
Communication protocol: No protocol system (Factory default setting)  P 0	P0
Communication protocol: With RS/CS control (Ready/Busy system)  P 1	P1
Communication protocol: ACK/NAK system  P 3	P3
CS waiting time: Not limited (Factory default setting)  I 0	I0
CS waiting time: 100 ms  I 1	I1
CS waiting time: 200 ms  I 2	I2
CS waiting time: 400 ms  I 3	I3





## Setting for the header and footer

Direct input header and footer of up to 4 digits can be set.

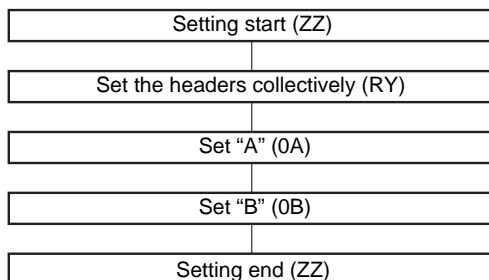
The number of digit output setting (p.84) can be included as 1 digit in the header.

E.g.: The following describes the steps for setting the header (AB).



Menu sheet	Command
Set the headers collectively (Applied to all codes)  R Y	RY
Clear the header (Applied to all codes)  M G	MG
Set the footers collectively (Applied to all codes)  R Z	RZ
Clear the footer (Applied to all codes)  P R	PR

## Number of digit output



Whether to output the number of digits to the data output format is specified.

This setting item can be registered as 1 item of the header and is added to a location determined by the order of registration.

Set "Clear the header (PR)" to clear the number of digit output.

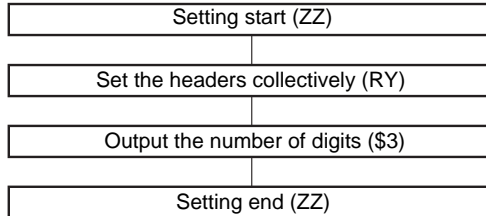
E.g.: The following describes the steps for setting the number of digit output.



Menu sheet	Command
Number of digit output (Bar code: 2 digits)   \$ 3	\$3
Number of digit output (Bar code: 6 digits)   \$ 6	\$6













CHECK!











The output format is as shown below.

- When the the number of digits output is set to [ZZRY\$3ZZ] (barcode 2 digits), the number of digits is "05" when the data of the barcode of the scanned code is "ABCDE".
- When the number of digits output is set to [ZZRY\$6ZZ] (barcode 6 digits), the number of digits is "000005" when the data of the barcode of the scanned code is "ABCDE".











## Direct code designation





Used to set character strings and values directly when designating the header or footer.

Menu sheet	Command
<SPACE> 	5A
! 	5B
" 	5C
# 	5D
\$ 	5E
% 	5F
& 	5G
' 	5H
( 	5I
) 	5J



Menu sheet	Command
* 	5K
+ 	5L
, 	5M
- 	5N
. 	5O
/ 	5P
: 	6A
; 	6B
< 	6C
= 	6D
> 	6E





















Menu sheet	Command
?  	6F
@  	6G
[  	7A
\  	7B
]  	7C
^  	7D
_  	7E
`  	7F
{  	9T
  	9U
}  	9V











Menu sheet	Command
~ 	9W
0 	Q0
1 	Q1
2 	Q2
3 	Q3
4 	Q4
5 	Q5
6 	Q6
7 	Q7
8 	Q8
9 	Q9











Menu sheet		Command
A	 0 A	0A
B	 0 B	0B
C	 0 C	0C
D	 0 D	0D
E	 0 E	0E
F	 0 F	0F
G	 0 G	0G
H	 0 H	0H
I	 0 I	0I
J	 0 J	0J
K	 0 K	0K

Menu sheet		Command
L	 0 L	0L
M	 0 M	0M
N	 0 N	0N
O	 0 0	0O
P	 0 P	0P
Q	 0 Q	0Q
R	 0 R	0R
S	 0 S	0S
T	 0 T	0T
U	 0 U	0U
V	 0 V	0V











Menu sheet	Command
W  	0W
X  	0X
Y  	0Y
Z  	0Z
a  	SA
b  	SB
c  	SC
d  	SD
e  	SE
f  	SF
g  	SG







Menu sheet		Command
h		\$H
i		\$I
j		\$J
k		\$K
l		\$L
m		\$M
n		\$N
o		\$O
p		\$P
q		\$Q
r		\$R

Menu sheet	Command
s 	\$S
t 	\$T
u 	\$U
v 	\$V
w 	\$W
x 	\$X
y 	\$Y
z 	\$Z
(NULL) 	9G
(SOH) 	1A
(STX) 	1B

Menu sheet	Command
(ETX) 	1C
(EOT) 	1D
(ENQ) 	1E
(ACK) 	1F
(BEL) 	1G
(BS) 	1H
(HT) 	1I
(LF) 	1J
(VT) 	1K
(FF) 	1L
(CR) 	1M



Menu sheet	Command
(SO) 	1N
(SI) 	1O
(DLE) 	1P
(DC1) 	1Q
(DC2) 	1R
(DC3) 	1S
(DC4) 	1T
(NAK) 	1U
(SYN) 	1V
(ETB) 	1W
(CAN) 	1X

Menu sheet	Command
(EM) 	1Y
(SUB) 	1Z
(ESC) 	9A
(FS) 	9B
(GS) 	9C
(RS) 	9D
(US) 	9E
DELL 	9F

# Section 5

## Example of System Configuration

This section explains about connection method with upper equipment.

☒ Example of Connection with a PC	98
☒ Example of Connection with Programmable Controller (CS1)	99
☒ Example of Multi-drop Connection	102
☒ How to Use Command Link Unit V700-L12	106

## Example of Connection with a PC

Example of connection with PC/AT compatible PC is explained.

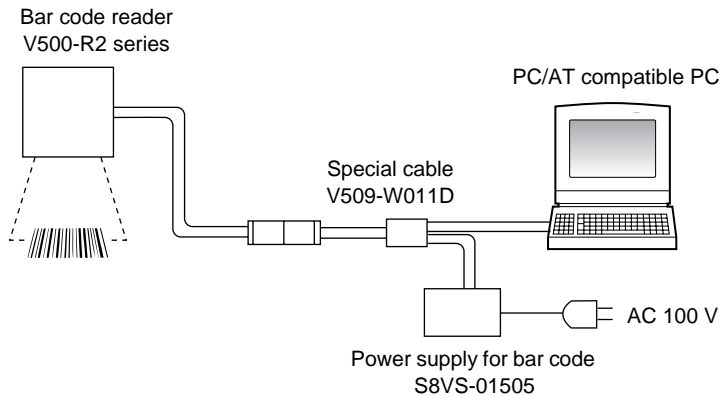

### Example of BASIC program

```
100 CLS
110 CLOSE #1
120 OPEN "COM:N81NN" AS #1
130 BCDATA$=""
140 AA$=INPUT$(1,#1)
150 IF AA$=CHR$(&H03) GOTO 170
160 BCDATA$=BCDATA$+AA$:GOTO 140
170 PRINT "READ DATA=" ; BCDATA$
180 GOTO 130
```

# Example of Connection with Programmable Controller (CS1)

Connection with programmable controller CS1 (Made by OMRON) is explained.

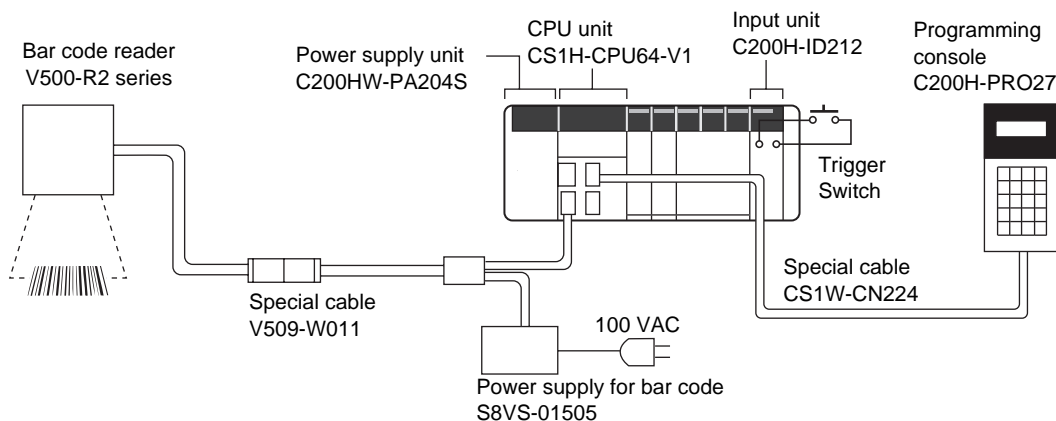

Connect the connection cable of this bar code reader to RS-232C port of the CPU unit.

## Setting at bar code side

Set as follows, using EDB command (collective setting for programmable controller connection).

 p.60

Setting item	Setting content	Command
Communication speed	9600 bps	(Same as initial setting)
Data length	7-bit	L0
Parity	Even number	L3
Stop bit	2-bit	L6
Header	None	(Same as initial setting)
Footer	CR	(Same as initial setting)
Reading valid time	Trigger + 2 sec.	Y2
Process when reading failed	?[CR] or > [CR] is transferred	5H

## Setting of CS1 side

For detail setting method, refer to the operation manual of your programmable controller.

Setting item	Setting content
Dip switch of CPU unit	OFF
PC system setting	160[8300]
	161[0000]
	164[000D]
	165[0100]
DM setting	Set [1B5A] to DM00100. (Memorize "Z" of ASCII code)

## Example of program

When the trigger switch is turned on, the bar code reader starts reading operation and stores the read data to DM (data memory) of CS1. The content is displayed on the programming console. When the bar code cannot read within the duration which is set beforehand (2 sec. in this example), "?" or ">" is transmitted.

To check the read data with the programming console, press "Clear > FUN > Monitor" in this order.

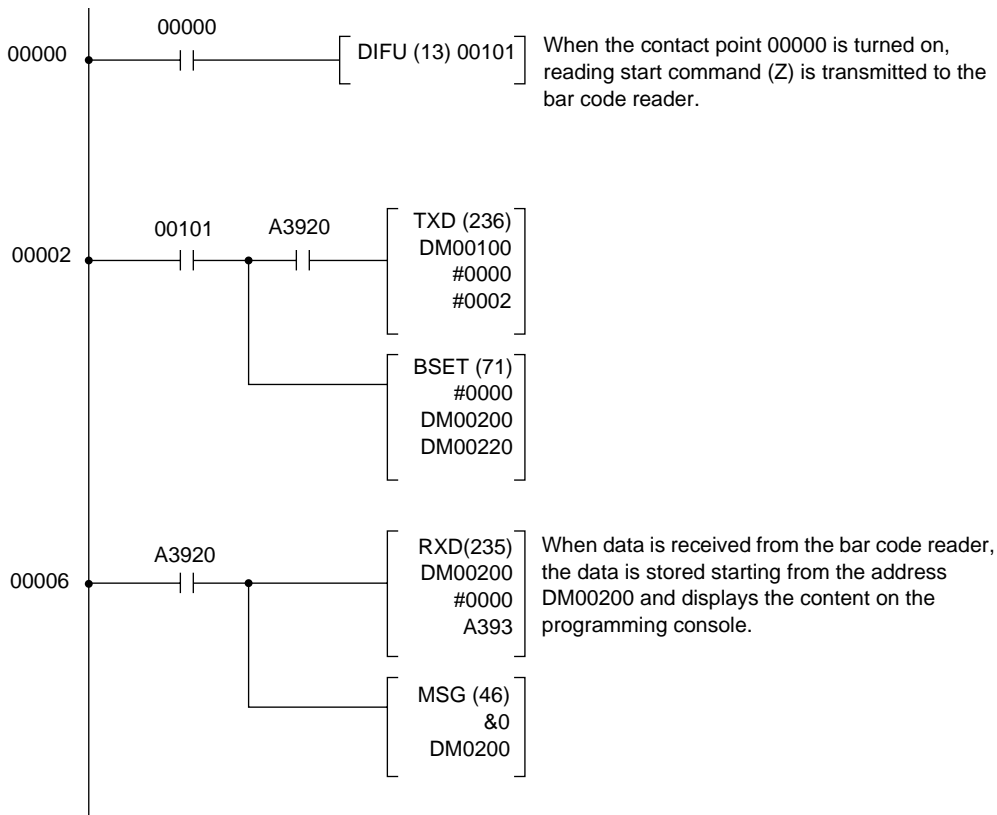

For the program command, refer to the operation manual of your programming console. (Items related to communication method by RS-232C nonprocedural system.)

## Example of Multi-drop Connection

When communication link unit V700-L12 (sold separately) is used, you can connect max. 31 sets of the bar code reader to one upper equipment. This is called multi-drop connection. Connection configuration differs according to the interface (RS-485 or RS-232C) of the upper equipment side.

Example of connecting communication link unit (hereinafter referred to as "link unit") and the upper equipment using RS-485 is described in this section.

You can supply 5 V power to the bar code reader from V700-L12.



CHECK!

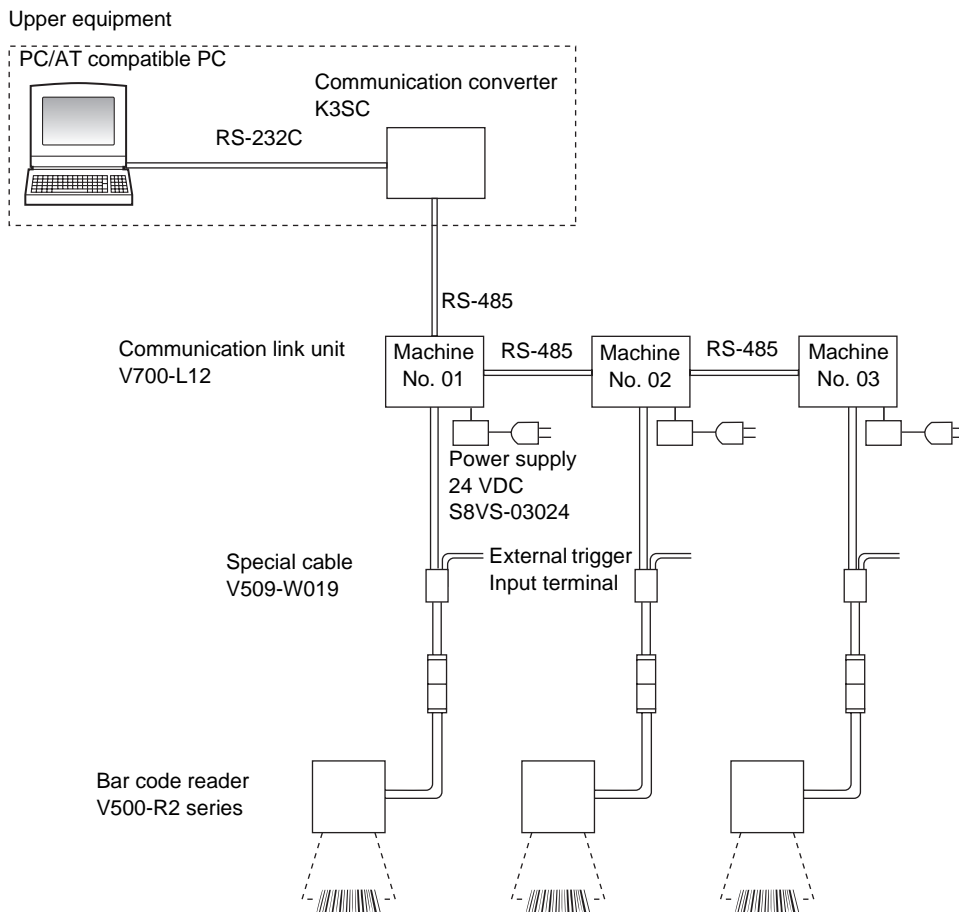



## Setting at bar code reader side

Set as follows, using EDA command (collective setting for link unit connection).

 p.61

Setting item	Setting content	Command
Communication speed	9600 bps	(Same as initial setting)
Data length	8-bit	(Same as initial setting)
Parity	Even number	L3
Stop bit	1-bit	(Same as initial setting)
Header	None	(Same as initial setting)
Footer	CR	(Same as initial setting)
RS/CS control	None	P0
Process when reading is NG	? [CR] or > [CR] is transmitted	5H
Other setting	Same as factory default setting.	-

## Setting at link unit V700-L12 side

Setting item	Setting content	Setting
Machine No.	Set the machine No. differing in each link unit	Set DIP-SW 1 to 5.
Communication speed	9600 bps	DIP-SW 6, 7 are OFF
Transmission procedure	Normal procedure (polling procedure)	DIP-SW8 is OFF
Connection check	None	DIP-SW9 is OFF
RS-485 termination resistance	2 sets on both sides of transmission path are turned ON (*)	In case when turned ON, DIP-SW10 is ON

\* In case of connection example shown here, termination resistors of the machine No. 3 and the upper equipment (interface converter) are turned ON.

 Specification and wiring of the link unit p.103

## Operation flow chart

Each bar code reader reads bar codes when the trigger is input. Read data is transmitted to the unit and stored in a buffer inside the link unit.

When the data export command (polling command) is transmitted from the upper equipment, the link unit transmits the stored read data to the upper equipment.

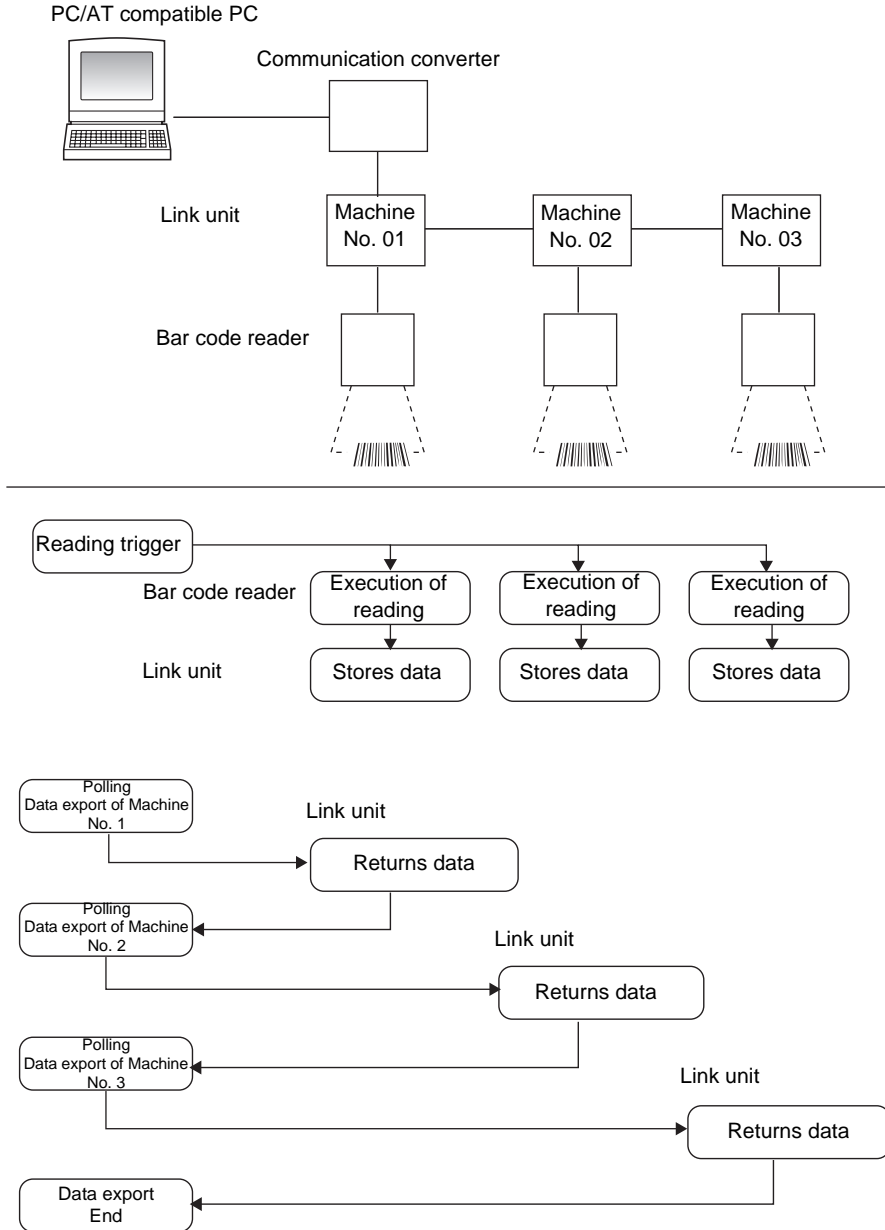

## Communication format

Communication format used in this connection example is explained.  
For details, refer to the following page.

 p.115

### ■ Reading trigger given from the upper unit

\$01	(Machine No.)	ESC	Z	(Check code)	\$0D
------	---------------	-----	---	--------------	------

E.g.: When a trigger is given to the bar code reader machine No. 2

\$01	0	2	ESC	Z	(Check code)	\$0D
------	---	---	-----	---	--------------	------

### ■ Polling command given from the upper equipment

\$01	(Machine No.)	DLE	P	(Check code)	\$0D
------	---------------	-----	---	--------------	------

E.g.: When exporting data of machine No. 2

\$01	0	2	DLE	P	(Check code)	\$0D
------	---	---	-----	---	--------------	------

### ■ Reading data transmitted from the bar code reader

\$01	(Machine No.)			Reading data		(Check code)	\$0D
------	---------------	--	--	--------------	--	--------------	------

E.g.: When the reading data of the machine No. 2 is "ABCDE"

\$01	0	2	A	B	C	D	E	(Check code)	\$0D
------	---	---	---	---	---	---	---	--------------	------

E.g.: When the read data is not accumulated

\$01	(Machine No.)	7	4	(Check code)	\$0D
------	---------------	---	---	--------------	------

Code indicating that there is no data

### ■ When the bar code reader setting is changed from the upper equipment

\$01	(Machine No.)	ESC	(m1)	(m2)	(Check code)	\$0D
------	---------------	-----	------	------	--------------	------

Command character string

# How to Use Command Link Unit V700-L12

V700-L12 is a communication link unit for communication relay of RS-232C output equipment such as bar code readers and RFID system. (Hereinafter refer to as "link unit".) It is used to connect plural sets of RS-232C output equipment to one port of the upper equipment.



CHECK!

Information only required for connection of the bar code reader and the link unit is described here. When used, be sure to read the operation manual of the link unit V700-L12.

## Part names

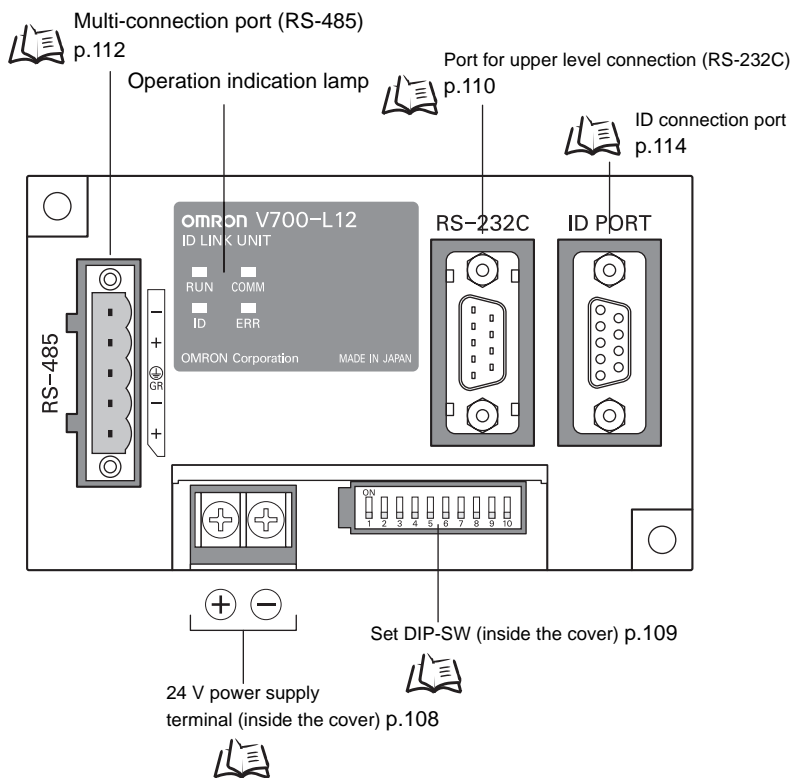

Operation indication lamp

Operation condition of the link unit is indicated with four LED.

LED	Description
RUN	Illuminate during normal operation of the link unit.
COMM	Illuminate during data communication with the upper equipment.
ID	Illuminate during data communication with the bar code reader.
ERR	Illuminate in the event of a failure during data communication with upper equipment or a bar code reader.

### ⚠ CAUTION

GR (frame ground) terminal is in the multi-connection port.

D type grounding (former type 3 grounding) should be performed.



## General specification

Item	Specification
Number of connected antenna set	1
Power voltage	24 VDC + 10 % -15 %
Power consumption	10 W or less
Insulation resistance	50 mM ohm or more (at 500 VDC mega), between power terminal bulk blocs and ground terminals
Withstand voltage	100 VAC (50/60 Hz, 1 min), apply to power terminals and ground terminals, and leak current must be 5 mA or less
Resistance to vibration	10 to 150 Hz, double amplitude 0.20 mm, vibration with acceleration of 15 m/s <sup>2</sup> , at each X, Y, Z direction 8 min. each, 10 sweeps applied, without abnormal
Impact resistance	Apply shock with acceleration of 150 m/s <sup>2</sup> , 3 times for each X, Y, Z direction, total 18 times, without abnormality.
Ambient temperature	At operation: 0 to +45 °C At storage: -15 to +50 °C (without freeze or dew condensation)
Ambient humidity	At operation and storage: 35 to 85 % RH (without dew condensation)
Enclosure rating	IP20 (IEC60529 Standard)
Ground	D type grounding (former type 3 grounding)
Mass	Approx. 185 g

## Communication function

Item	Specification
Machine No.	01 to 31
Communication speed with the upper equipment	48000/9600/19200/38400 bps
Data transmission procedure to the upper equipment	<p>Normal procedure (polling procedure)</p> <ul style="list-style-type: none"> <li>• When inputting data from the upper equipment, it outputs to the ID port immediately and transmits received reply to the upper equipment.</li> <li>• When inputting data from the ID port, it waits for the inquire command and transmits data.</li> <li>• In case of 1: N connection, this procedure is recommended.</li> </ul> <p>Through procedure (immediate transmission system)</p> <ul style="list-style-type: none"> <li>• When inputting data from the upper equipment, it outputs to the ID port immediately. It does not transmit the received reply to the upper equipment.</li> <li>• When inputting data from the ID port, it transmits to the upper equipment immediately.</li> </ul>
RS-485 termination resistance	OFF (invalid) ON (valid)



DIP-SW is used for setting each function.

## Power supply

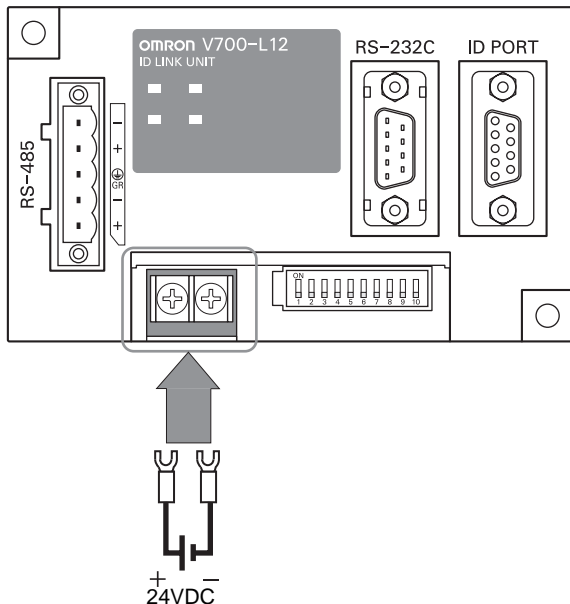
Open the cover of the upper side of the body. There is a power terminal.



The terminal mounting screw size is M3. Use a crimping terminal which fits to M3 screw.

Shape	Size
Fork type	6.0 mm or less 
Round type	6.0 mm or less 

Connect 24 V power supply device.

Recommended device

Manufacturer	Model
OMRON Corporation	S8VS-03024



Confirmation should be fully made if there is no mistake after wiring.  
Faulty wiring may be the cause of failure.

## Function setting

Set each function using the DIP-SW of the bar code reader.

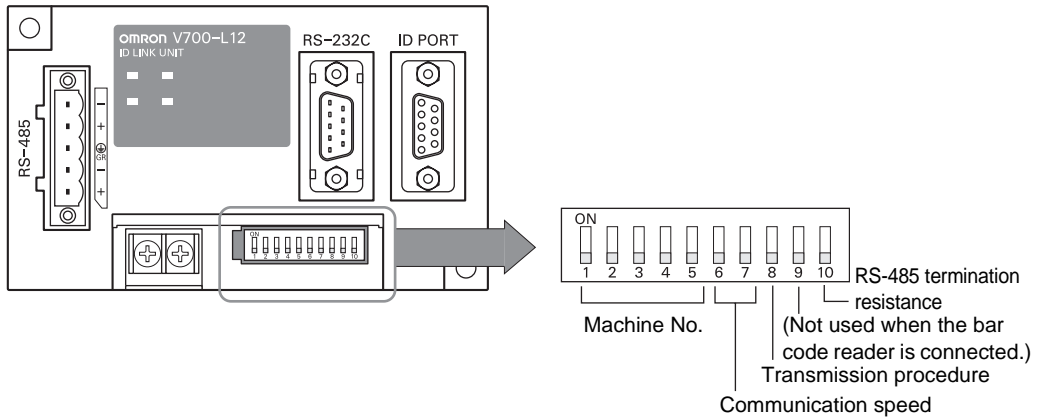

### Setting of machine No.

Machine No.	DIP-SW				
	1	2	3	4	5
01	OFF	OFF	OFF	OFF	OFF
02	ON	OFF	OFF	OFF	OFF
03	OFF	ON	OFF	OFF	OFF
04	ON	ON	OFF	OFF	OFF
05	OFF	OFF	ON	OFF	OFF
06	ON	OFF	ON	OFF	OFF
07	OFF	ON	ON	OFF	OFF
08	ON	ON	ON	OFF	OFF
09	OFF	OFF	OFF	ON	OFF
10	ON	OFF	OFF	ON	OFF
11	OFF	ON	OFF	ON	OFF
12	ON	ON	OFF	ON	OFF
13	OFF	OFF	ON	ON	OFF
14	ON	OFF	ON	ON	OFF
15	OFF	ON	ON	ON	OFF
16	ON	ON	ON	ON	OFF

Machine No.	DIP-SW				
	1	2	3	4	5
17	OFF	OFF	OFF	OFF	ON
18	ON	OFF	OFF	OFF	ON
19	OFF	ON	OFF	OFF	ON
20	ON	ON	OFF	OFF	ON
21	OFF	OFF	ON	OFF	ON
22	ON	OFF	ON	OFF	ON
23	OFF	ON	ON	OFF	ON
24	ON	ON	ON	OFF	ON
25	OFF	OFF	OFF	ON	ON
26	ON	OFF	OFF	ON	ON
27	OFF	ON	OFF	ON	ON
28	ON	ON	OFF	ON	ON
29	OFF	OFF	ON	ON	ON
30	ON	OFF	ON	ON	ON
31	OFF	ON	ON	ON	ON
Setting not allowed	ON	ON	ON	ON	ON

### Other setting

Setting item	Initial setting	Description
Communication speed	9600 bps	Communication speed between the link unit and the upper equipment is set. <ul style="list-style-type: none"> <li>4800 bps: DIP-SW6 is set to ON, DIP-SW7 is set to OFF</li> <li>9600 bps: DIP-SW6 is set to OFF, DIP-SW7 is set to OFF</li> <li>19200 bps: DIP-SW6 is set to OFF, DIP-SW7 is set to ON</li> <li>38400 bps: DIP-SW6 is set to ON, DIP-SW7 is set to ON</li> </ul>
Transmission procedure	Normal procedure	Set data transmission system to upper equipment. <ul style="list-style-type: none"> <li>Normal procedure (polling procedure): OFF</li> <li>Through procedure (immediate transmission system): ON</li> </ul>
RS-485 termination resistance	OFF (invalid)	Set whether to make RS-485 termination resistance valid. Turn on the link unit on both sides of transmission path. (When only one set is connected, turn it ON.)

## Upper connection port specification

A port to connect with the upper equipment using RS-232C. A dust cover is attached before shipping. Remove it when used.

Item	Specification				
Connector specification	D-sub 9 pin Connector plug Lock screw: #4-40UNC				
Cable length	Max. 15 m				
Communication system	In compliance with RS-232C				
Synchronous system	Asynchronous system				
Communication control system	One-to-N procedure dedicated to OMRON				
Communication speed	4800/9600/19200/38400 bps (Set with DIP-SW)				
Character format (fixed)	Start bit	Data bit	Parity bit	Stop bit	Total
	1	8	None	1	10
Check code (Error detection system)	FCS (Frame Check Sequence)/Vertical parity system				

### Pin arrangement

Connector cap is not conducting with GR (frame ground).

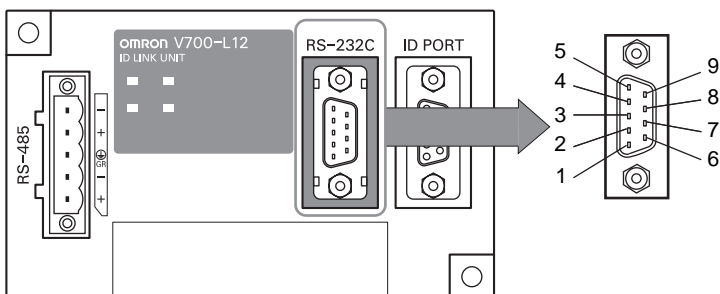

Pin No.	Signal name	Function	Signal direction
1	-	Not connected	-
2	RD	Received data	Input
3	SD	Transmission data	Output
4	-	Not connected	-
5	SG	Ground for signal	-
6	-	Not connected	-
7	RS	Transmission request (Normally ON when operating)	Output
8	CS	Transmission allowed	Input
9	-	Not connected	-



RS signal control from the upper equipment

In case of 1: N connection with RS-232C interface of the upper equipment, the RS signal of the upper equipment should be input to the CS signal of the link unit. Turn OFF the RS signal within 15ms after data transmission is finished. This control should be performed for normal operation.

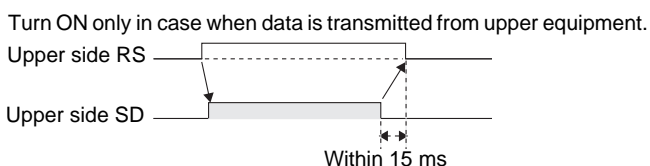



## ■ Wiring

Example of wiring when connecting with PC/AT compatible PC is explained.

Cable length should be 15 m or less.

Recommended parts

		Model	Manufacturer
Cable		CO-MA-VV-SB 5PX28AWG	Hitachi Cable, Ltd.
Connector	Socket	XM2D-0901	OMRON Corporation
	Hood	XM2S-0913	OMRON Corporation

### Wiring method 1

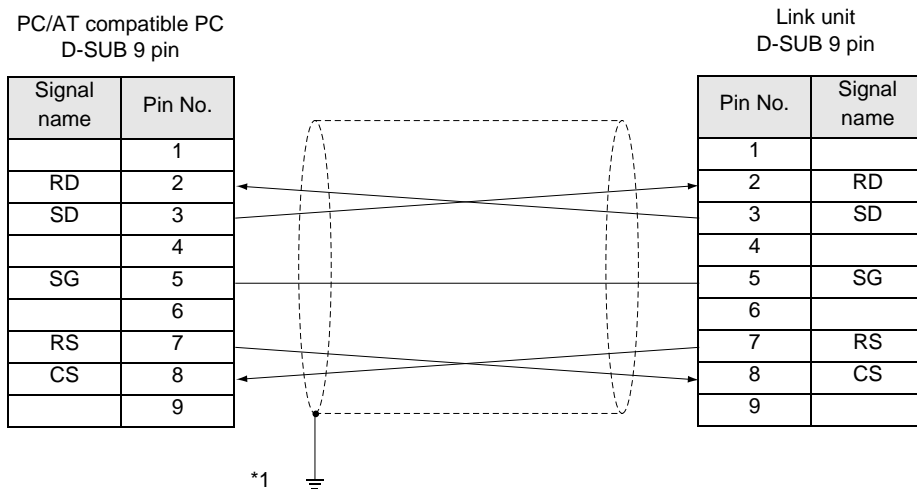

### Wiring method 2

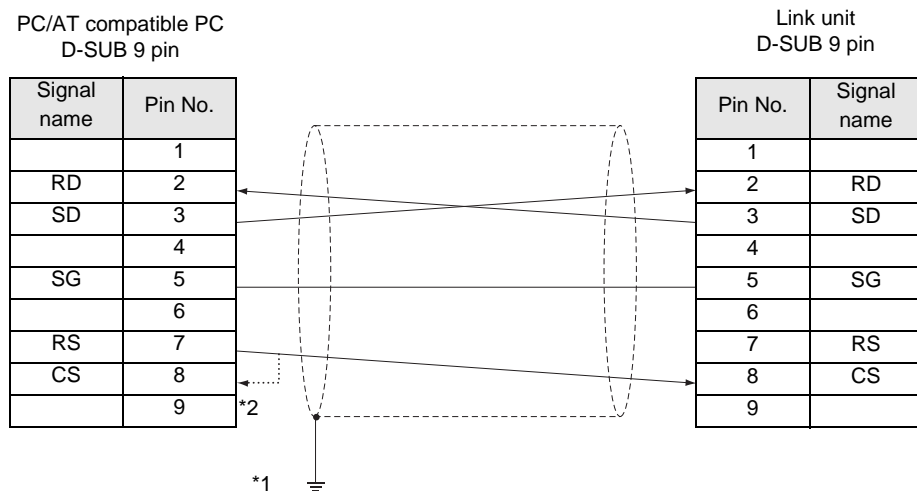

\*1 Ground the shield wire on either PC/AT compatible PC side or link unit side.

\*2 When CS function is used on PC side, a return line is required.

## Multi-connection port specification

When plural bar code readers are connected to one RS-232C port of the upper equipment, connect to a multi-connection port of other link unit.

When the upper equipment has the RS-485 port, connect this port to act as upper connection port. However, when the multi-connection port is used as the upper connection port, the upper connection port (RS-232C) of the link unit cannot be used. GR (frame ground) terminal is also on this port.

Item	Specification				
Connector specification	5 pin special connector (accessory for the link unit)				
Cable length	Total length: Max. 1 km				
Communication system	In compliance with RS-485				
Synchronous system	Asynchronous system				
Communication control system	One-to-N procedure dedicated to OMRON				
Communication speed	4800/9600/19200/38400 bps (Set with DIP-SW)				
Character format (fixed)	Start bit	Data bit	Parity bit	Stop bit	Total
	1	8	None	1	10
Error detection system	FCS (Frame Check Sequence)				

### Pin arrangement

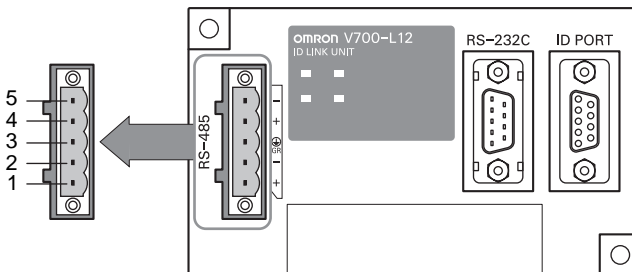

Pin No.	Signal name	Function
5	-	Short circuit with terminal 2 inside the circuit
4	+	Short circuit with terminal 1 inside the circuit
3	GR	Frame ground
2	-	Short circuit with terminal 5 inside the circuit
1	+	Short circuit with terminal 4 inside the circuit



When connecting with RS-485 interface of the upper equipment  
The upper equipment should be in data reception condition within 15 ms after data transmission.  
This control should be performed for normal operation.

### CAUTION

GR (frame ground) terminal is in the multi-connection port.  
D type grounding (former type 3 grounding) should be performed.



## ■ Cables

### Recommended parts

		Model	Manufacturer
Cable	RS-485 signal line	MVVS 2CX0.5SQ	Tachii Electric Wire Co., Ltd.
	Frame ground wire	(Cables of AWG22 to 20)	
Crimping terminal	When connecting one wire to one terminal	AI0.5-8WH	PHOENIX CONTACT
	When connecting two wires to one terminal	AI-TWIN2 x 0.5-8WH	
Tools for crimping terminal		CRIMPFOX UD6	

## ■ Wiring method

1. Attach crimping terminals on a cable where coating is peeled.
2. Insert each wire to each connector hole with attention to the direction of the connector.
3. Tighten the screws for fixing the connector cable.

Appropriate tightening torque is approx. 0.3 N.m.



When connecting with RS-485 interface of the upper equipment  
The upper equipment should be in data reception condition within 15 ms after data transmission. This control should be performed for normal operation.

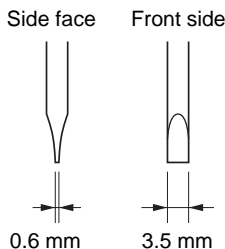

### Recommended driver

Manufacturer	Model
OMRON Corporation	XW4Z-00C

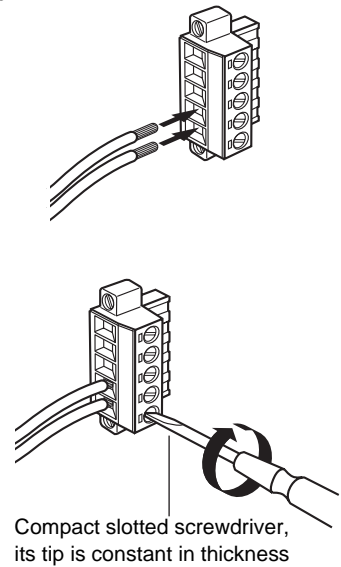

4. Connect the connector to the link unit.

Fit the direction of the connector on the link unit side and the cable, insert firmly to the end and tighten the fixing screws.



Uncoupling the connector  
Loosen two fixing screws completely and pull off the connector straight back holding the protrusion. When it is not pulled off easily, hold the link unit body and pull it again.

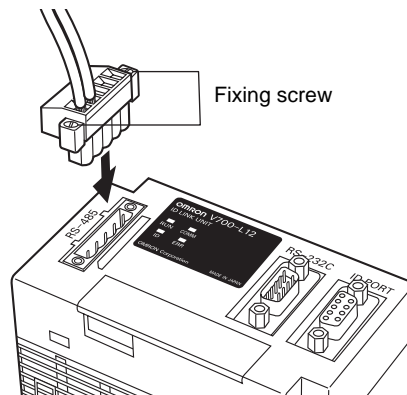

## ID connection port specification

This is a dedicated port to connect the bar code reader.

Item		Specification				
Connector specification		D-Sub 9 pin connector socket M2.6				
Power supply	Electrical power supply	5 V $\pm$ 5 %				
Communication part	Communication system	In compliance with RS-232C				
	Synchronous system	Asynchronous system				
	Communication control system	One-to-one procedure dedicated to OMRON				
	Communication speed (fixed)	9600 bps				
	Character format (fixed)	Start bit	Data bit	Parity bit	Stop bit	Total
		1	8	None	1	10
Error detection system		Even number parity				

### Pin arrangement

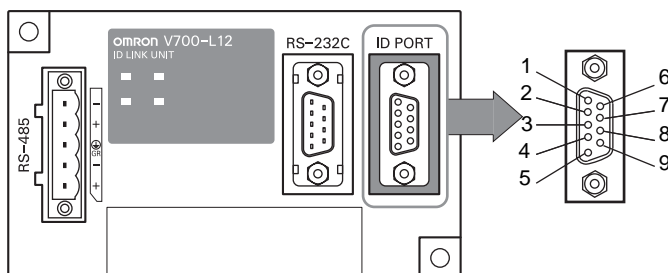

Pin No.	Signal name	Function	Signal direction
1	-	Not connected	-
2	SD	Transmission data	Output
3	RD	Received data	Input
4	RS	Transmission request	Output
5	CS	Transmission permitted (Normally ON when operating)	Input
6	5V	+5 V (5VDC $\pm$ 5 %) supply	Output
7	0V	+0 V supply (connected to SG internally)	Output
8	-	Transmission allowed	-
9	SG	Ground for signal	-

## Command specification

Command to control the link unit (in case of one-to-N procedure dedicated to OMRON) is explained in this section. Transmit so that distance between each character of the command is less than 200 ms. When the distance is 200 ms or more, it is recognized as separation of commands.

SOH	Machine No.	Communication data with the bar code reader	Check code	CR
\$01				

Designation of link unit process (DLE) command

Item	Description
SOH (Start Of Header)	Control code (\$01) indicating the head of a frame
Machine No.	Machine No. (1 to 32, 99) set with the DIP-SW. When the machine No. is 99, all units are regarded as own machine.
Bar code reader and communication data	Upper equipment > link unit Command data to transmit to the bar code reader. However, in case when the first character is DLE (10 h), it is handled as link unit process command defined by the next character. <ul style="list-style-type: none"> <li>• P (50 h): Polling (Invalid in case of through procedure)</li> <li>• R (52 h): Resend request</li> <li>• C (43 h): Buffer clear</li> </ul>
	Link unit > Upper equipment Response data from the bar code reader
Check code	2 characters of 8-bit from the character immediately after SOH to immediately before the check code, removing each exclusive OR (ExOR) which is converted to ASCII code. E.g.: In case of [SOH]01020000000600 (check code) [CR] Check code = "05" 30h (ExOR) 31h (ExOR) 30h (ExOR) 32h (ExOR) 30h (ExOR) 30h (ExOR) 30h (ExOR) 30h (ExOR) 30h (ExOR) 30h (ExOR) 30h (ExOR) 30h (ExOR) 30h (ExOR) 30h (ExOR) 36h (ExOR) 30h (ExOR) 30h = 05h <span style="float: right;">(ASCII conversion) ↓ "0" (30h) "5" (35h)</span>
CR (Carriage Return)	Control code (\$0D) indicating the end of a frame

■ **Polling (P)**

When the transmission procedure is "Normal procedure (polling procedure)", transmit the oldest data in the buffer as a response.

■ **Input command**

\$01	(Machine No.)	\$10	P	(Check code)	\$0D
------	---------------	------	---	--------------	------

■ **Response**

When there is data in buffer

\$01	(Machine No.)		Communication data with the bar code reader		(Check code)	\$0D
------	---------------	--	---	--	--------------	------

When there is no data in buffer

\$01	(Machine No.)	7	4	(Check code)	\$0D
------	---------------	---	---	--------------	------

  
 Code indicating that there is no data

In case of "Through procedure (normal output procedure)", no response is output even if command is input.

■ **Resend request (R)**

The response sent before is transmitted again.

■ **Input command**

\$01	(Machine No.)	\$10	R	(Check code)	\$0D
------	---------------	------	---	--------------	------

■ **Response**

\$01	(Machine No.)		Communication data with the bar code (same as immediately before)		(Check code)	\$0D
------	---------------	--	---	--	--------------	------

■ Buffer clear (C)

Clears all the buffer in the link unit.

▪ Input command

\$01	(Machine No.)	\$10	C	(Check code)	\$0D
------	---------------	------	---	--------------	------

▪ Response

\$01	(Machine No.)	0	0	(Check code)	\$0D
------	---------------	---	---	--------------	------

When a code other than 00 is returned p.120

■ Change the communication frame with the bar code reader to [CR] (X)

▪ Input command

\$01	(Machine No.)	\$10	X	(Check code)	\$0D
------	---------------	------	---	--------------	------

▪ Response

\$01	(Machine No.)	0	0	(Check code)	\$0D
------	---------------	---	---	--------------	------

When a code other than 00 is returned p.120

Communication frame with the bar code is as shown below.

Communication data with the bar code reader								CR
								\$0D

Control code indicating frame end

■ Change the communication frame with the bar code reader to [STX] to [ETX] (Y)

▪ Input command

\$01	(Machine No.)	\$10	Y	(Check code)	\$0D
------	---------------	------	---	--------------	------

▪ Response

\$01	(Machine No.)	0	0	(Check code)	\$0D
------	---------------	---	---	--------------	------

When a code other than 00 is returned p.120

Communication frame with the bar code is as shown below.

SOH	Communication data with the bar code reader								CR
\$02									\$03

Control code indicating frame start

Control code indicating frame end

However, it returns to default ([CR] mode) when the power is turned on or off.

## Connection with upper equipment

### ■ When connected with RS-232C

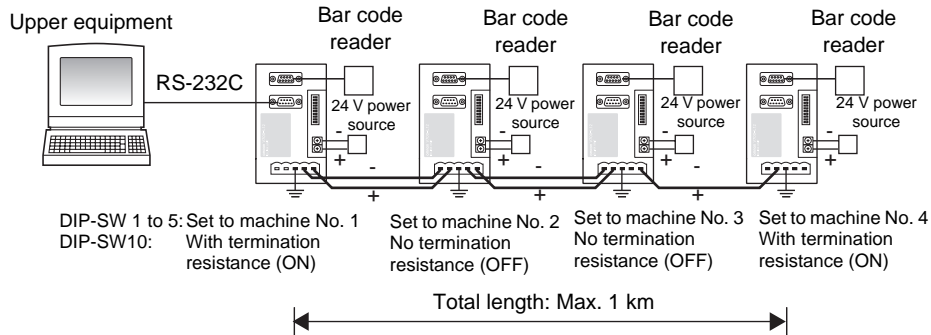

When connecting with 1:N using the link unit, it is required to input the RS signal normally controlled by the upper equipment to the CS signal. Turn OFF the RS signal within 15 ms after data transmission is finished. This control should be performed for normal operation.

### ■ How to deal in case when RS signal control on the upper equipment is impossible

Connect the upper equipment to the RS-485 communication line using K3SC-10, which makes communication switching control using RS signal unnecessary.

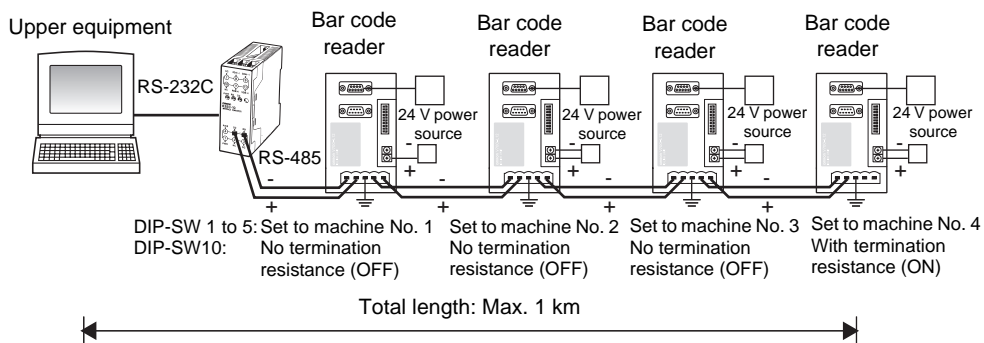



■ When connected with RS-485

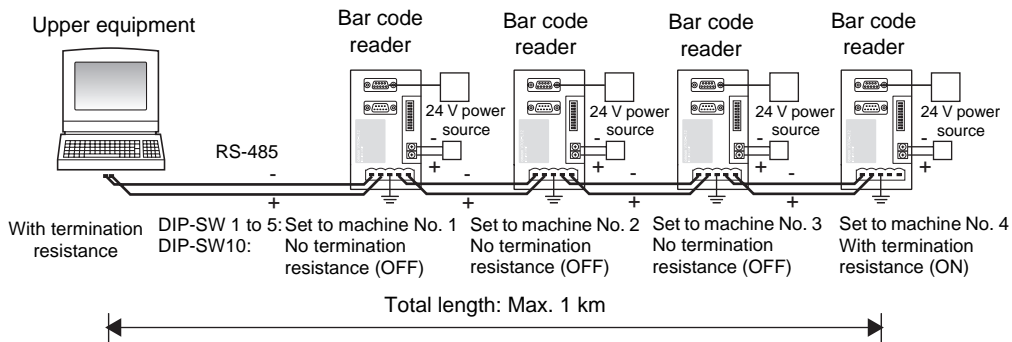

The upper equipment should be in data reception condition within 15 ms after data transmission. This control should be performed for normal operation.

## Troubleshooting of link unit

### ■ In case of no response (cannot receive) or garble

You can check the error condition with illumination condition of the operation indication lamp.

Operation indication lamp ● : Lights out ○ : Illuminate

RUN	COMM	ID	ERR	Check point
○	●	●	●	<ul style="list-style-type: none"> <li>• Connection of RS-232C cable (Wrong connection)</li> <li>• Command format (Existence of [SOH])</li> </ul>
○	●	●	○	<ul style="list-style-type: none"> <li>• Inconsistency of communication condition setting on upper equipment side (communication speed, etc.) and communication setting on the link unit side</li> <li>• RS-232C cable wiring (effect of circumference noise)</li> </ul>
○	○	●	●	<ul style="list-style-type: none"> <li>• Inconsistency of the machine No. designated with the command and the machine No. setting on the link unit side</li> </ul>
○	○	●	○	<ul style="list-style-type: none"> <li>• Command format ([CR], calculation of check codes, distance of command characters, etc.)</li> <li>• RS-232C cable wiring (effect of circumference noise)</li> <li>• There are 2 sets or more machine No. settings of the link unit on one system (*1)</li> </ul>
○	○	○	●	<ul style="list-style-type: none"> <li>• Connection of RS-232C cable (Wrong connection)</li> <li>• When connected to the upper equipment with RS-485, switching timing (time) of communication with the upper equipment</li> </ul>
●	●	●	●	<ul style="list-style-type: none"> <li>• 24 VDC power source line check</li> </ul>

\*1 Operation indication lamp repeats to blink other than during command transmission.

### ■ When only a specified link unit communication is abnormal

You can check the error condition with illumination condition of the operation indication lamp.

Operation indication lamp ● : Lights out ○ : Illuminate

RUN	COMM	ID	ERR	Check point
○	●	●	●	<ul style="list-style-type: none"> <li>• Connection of RS-485 cable (Wrong connection)</li> <li>• Connection of RS-232C cable (Wrong connection)</li> <li>• RS signal control with the upper equipment (RS signal is always OFF or turns ON after command transmission) (*2)</li> </ul>
○	●	●	○	<ul style="list-style-type: none"> <li>• Inconsistency of communication condition setting on upper equipment side (communication speed, etc.) and communication setting on the link unit side</li> <li>• RS-485 cable wiring (effect of circumference noise)</li> </ul>
○	○	●	●	<ul style="list-style-type: none"> <li>• Inconsistency of communication condition setting on upper equipment side (communication speed, etc.) and communication setting on the link unit side</li> </ul>
○	○	●	○	<ul style="list-style-type: none"> <li>• RS signal control of the upper equipment (Turns OFF before ending command transmission) (*2)</li> </ul>
○	○	○	●	<ul style="list-style-type: none"> <li>• RS signal control of the upper equipment (RS signal is always ON) (*2)</li> </ul>
●	●	●	●	<ul style="list-style-type: none"> <li>• 24 VDC power source line check</li> </ul>

\*2  Upper connection port p.110

■ **Error code**





When following codes are returned as a response, error occurred. Check by referring following table.

End code	Error cause	Check point
93	Bar code reader communication malfunction	<ul style="list-style-type: none"> <li>• Cable wiring of the bar code reader (effect of circumference noise)</li> </ul>
9A	Bar code reader malfunction	<ul style="list-style-type: none"> <li>• Connection of the interface connector to the bar code reader</li> <li>• Bar code reader cable disconnection</li> </ul>

MEMO

# Section 6

## Appendix

 External Dimension	124
 Troubleshooting	129
 ASCII Code Table	130
 Explanation of Terms	131
 Corresponding Bar Code List	136

# External Dimension

Bar code reader  
V500-R2CF

(Unit: mm)

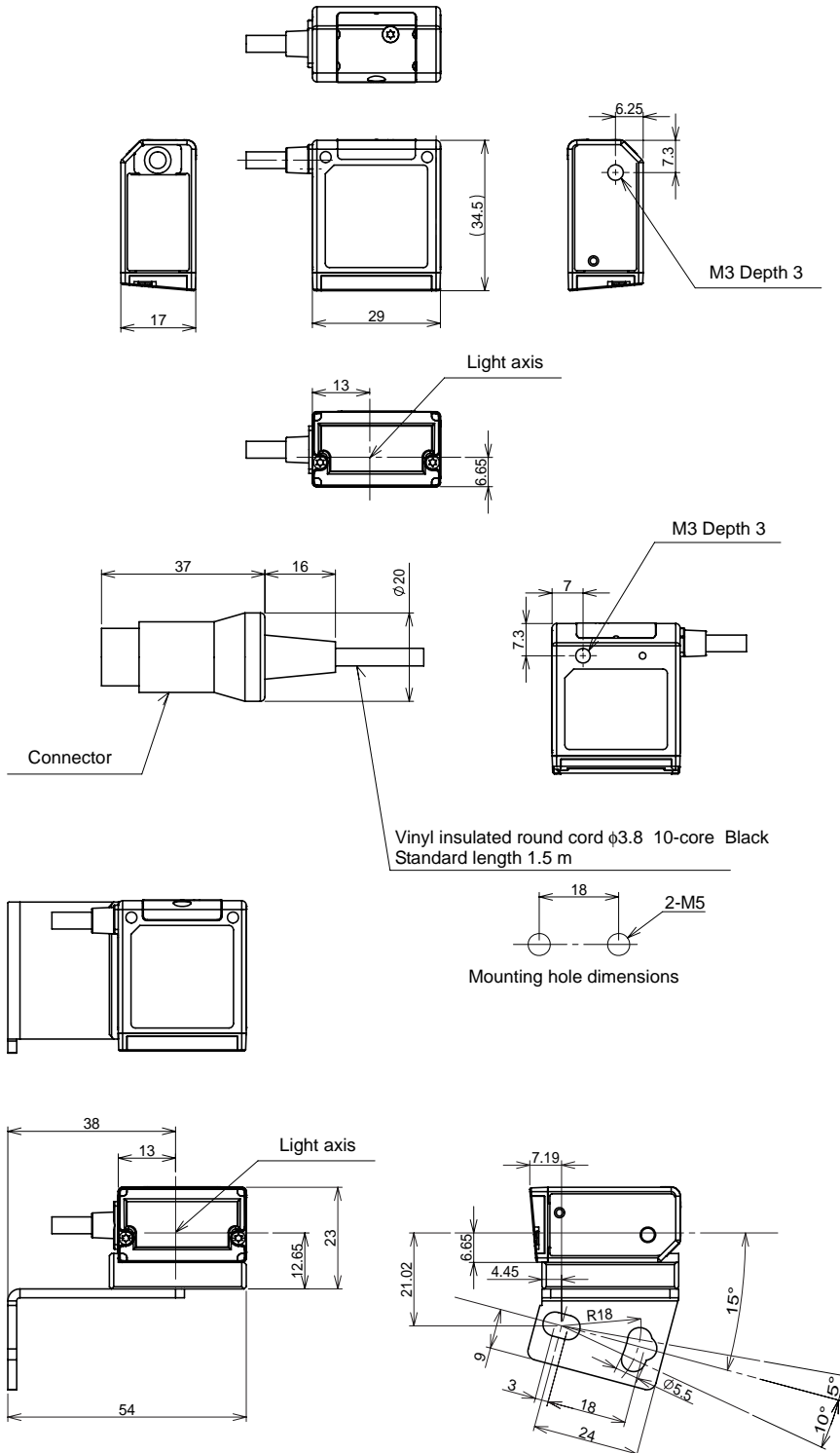

**Cable for programmable controller connection made by OMRON  
V509-W011**

(Unit: mm)

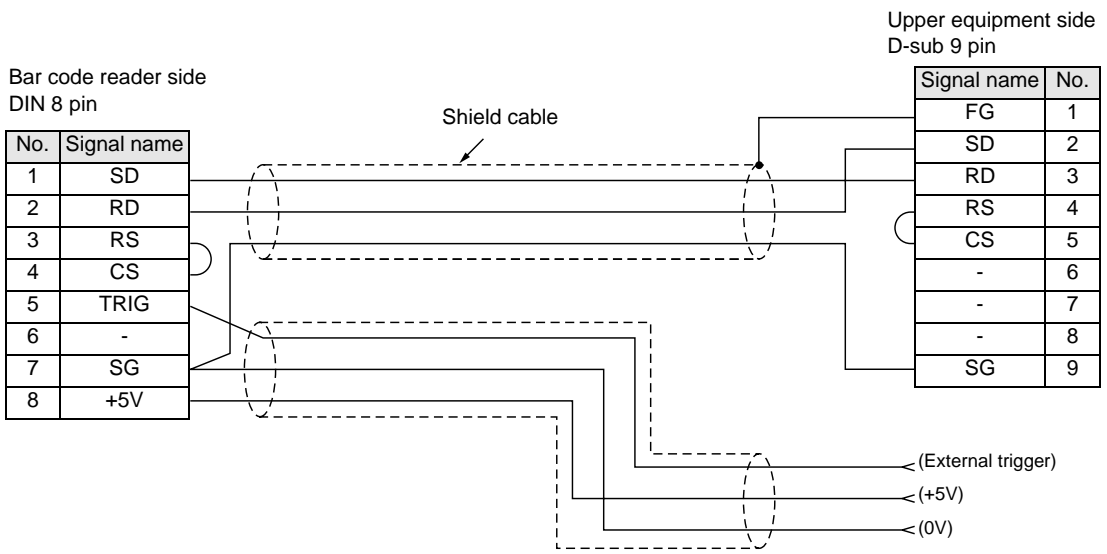
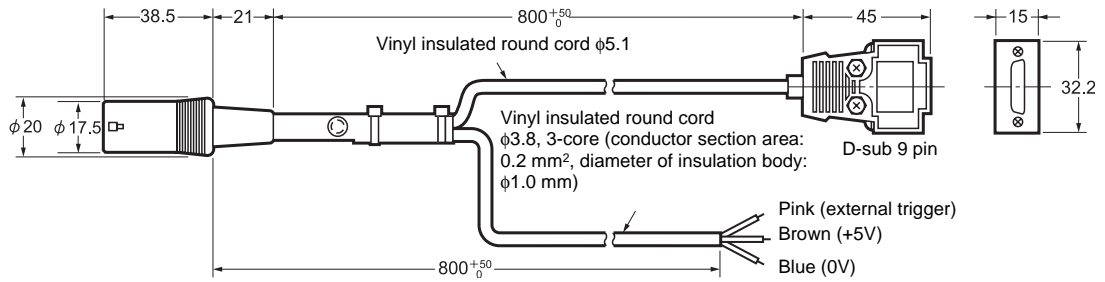

Cable for connecting with PC/AT compatible PC  
V509-W011D

(Unit: mm)

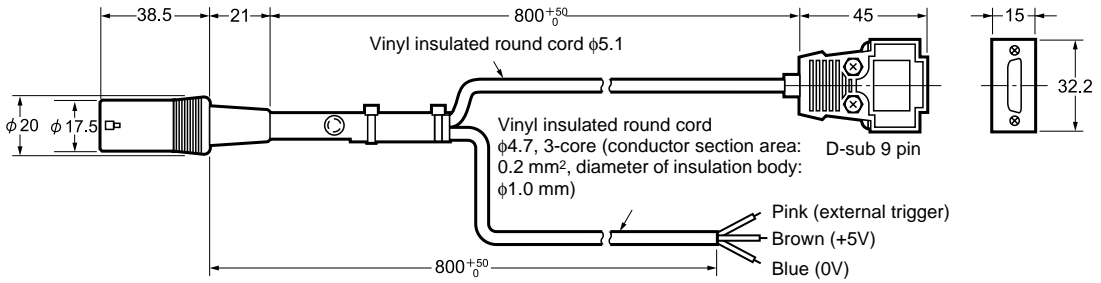

Bar code reader side  
DIN 8 pin

Upper equipment side  
D-sub 9 pin

No.	Signal name
1	SD
2	RD
3	RS
4	CS
5	TRIG
6	-
7	SG
8	+5V

Signal name	No.
-	1
RD	2
SD	3
ER	4
SG	5
DR	6
RS	7
CS	8
-	9
Shield wire	Connector Cover

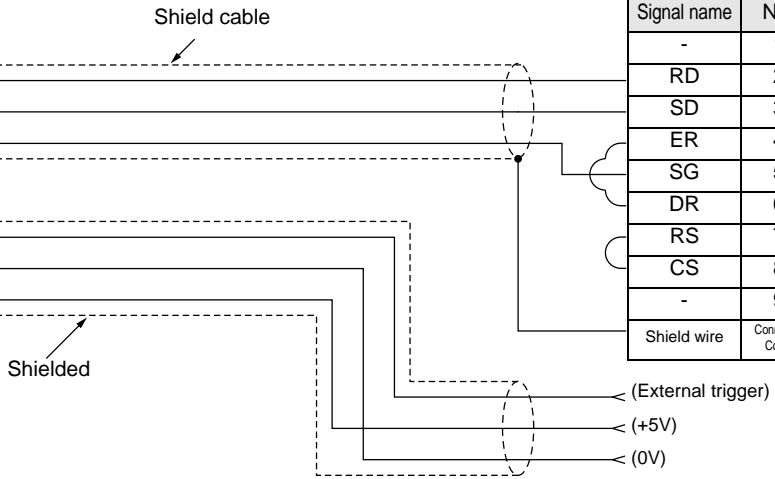



Communication link unit V700-L12 connection cable  
V509-W019

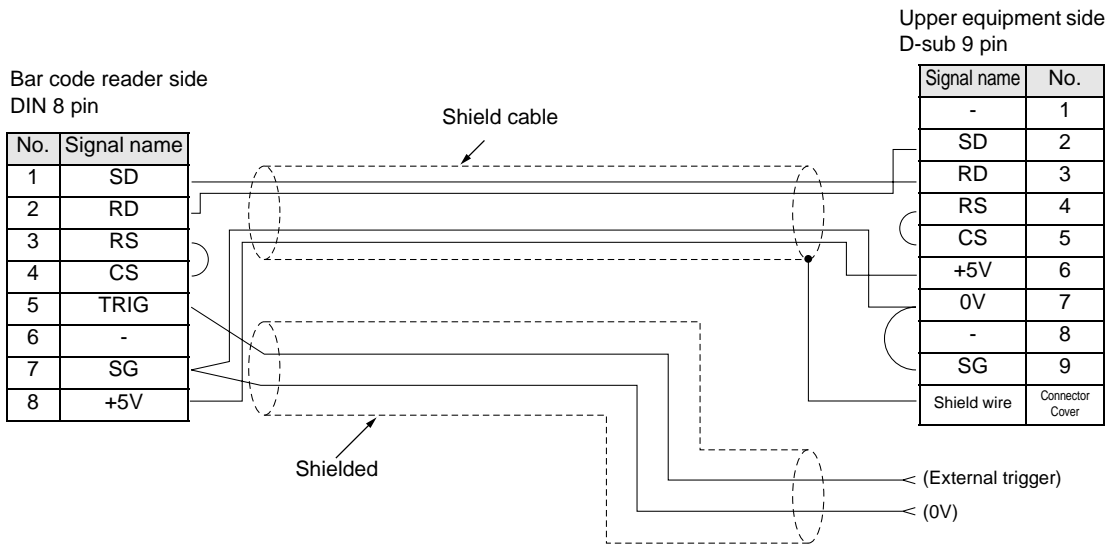
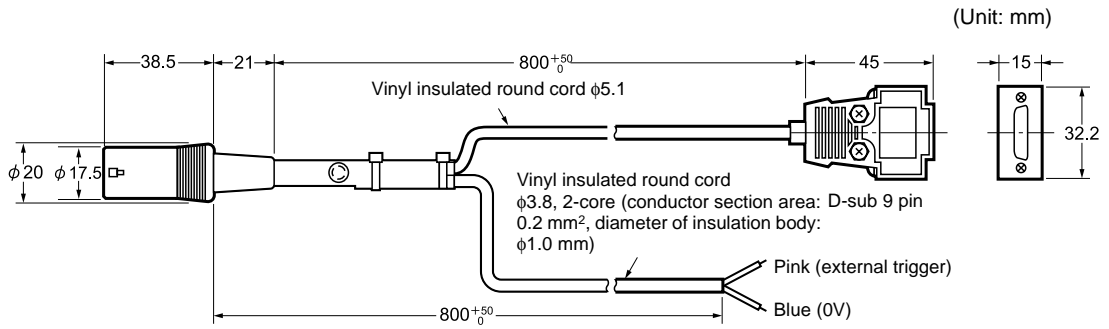

Communication link unit  
V700-L12

(Unit: mm)

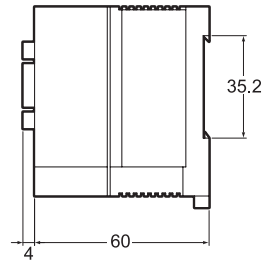
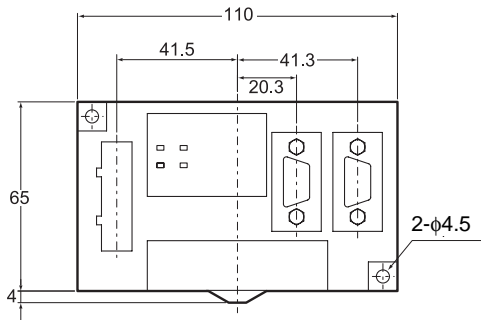

Dimension of mounting hole process

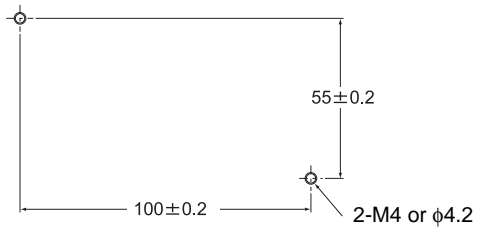

# Troubleshooting

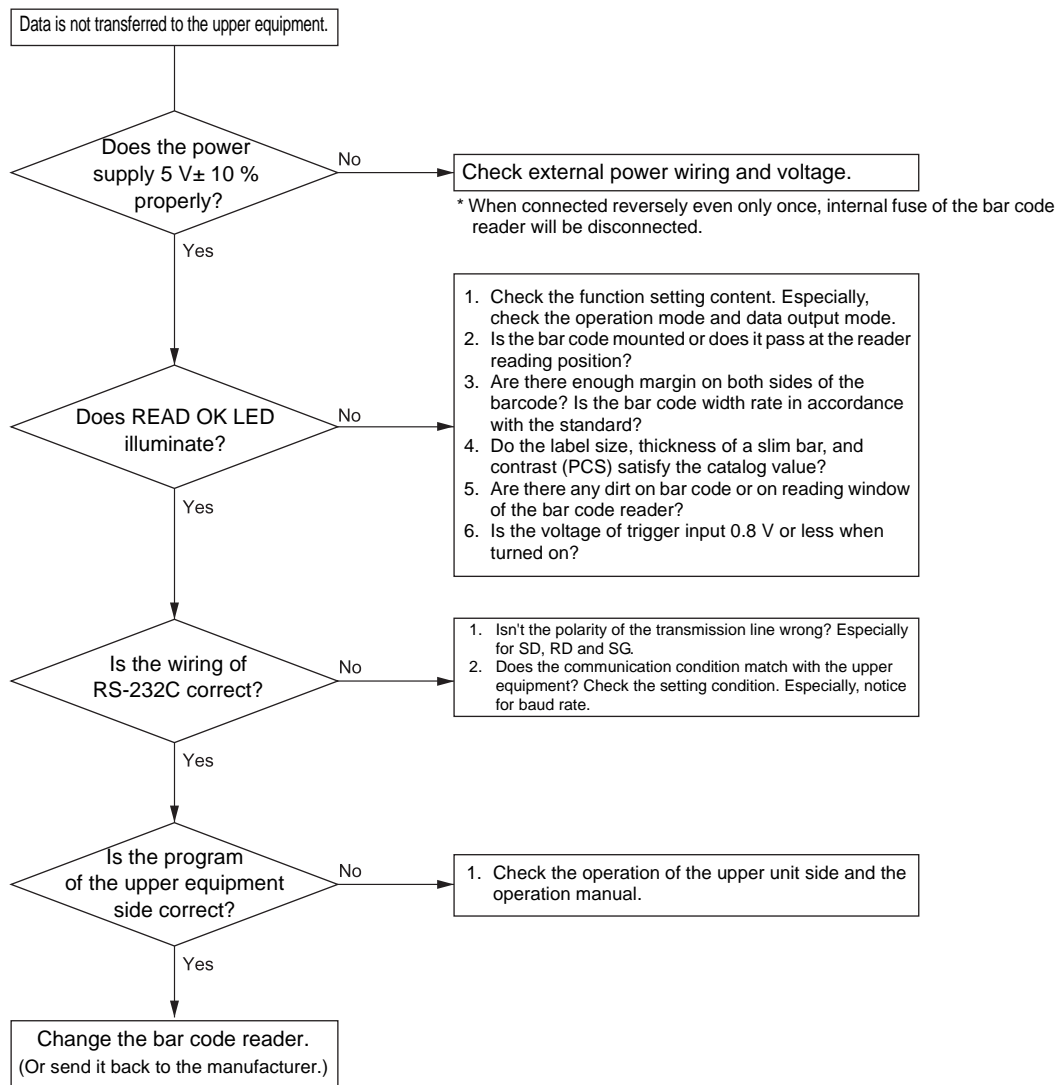

 Troubleshooting when communication link unit is used p.120

# ASCII Code Table

Character	Data (Hexadecimal number)	Character	Data (Hexadecimal number)	Character	Data (Hexadecimal number)	Character	Data (Hexadecimal number)
NUL	00	SP	20	@	40	'	60
SOH	01	!	21	A	41	a	61
STX	02	"	22	B	42	b	62
ETX	03	#	23	C	43	c	63
EOT	04	\$	24	D	44	d	64
ENQ	05	%	25	E	45	e	65
ACK	06	&	26	F	46	f	66
BEL	07	'	27	G	47	g	67
BS	08	(	28	H	48	h	68
HT	09	)	29	I	49	i	69
LF	0A	*	2A	J	4A	j	6A
VT	0B	+	2B	K	4B	k	6B
FF	0C	,	2C	L	4C	l	6C
CR	0D	-	2D	M	4D	m	6D
S0	0E	.	2E	N	4E	n	6E
S1	0F	/	2F	O	4F	o	6F
DLE	10	0	30	P	50	p	70
DC1	11	1	31	Q	51	q	71
DC2	12	2	32	R	52	r	72
DC3	13	3	33	S	53	s	73
DC4	14	4	34	T	54	t	74
NAK	15	5	35	U	55	u	75
SYN	16	6	36	V	56	v	76
ETB	17	7	37	W	57	w	77
CAN	18	8	38	X	58	x	78
EM	19	9	39	Y	59	y	79
SUB	1A	:	3A	Z	5A	z	7A
ESC	1B	;	3B	[	5B	{	7B
FS	1C	<	3C	¥(\)	5C		7C
GS	1D	=	3D	]	5D	}	7D
RS	1E	>	3E	^	5E	(~)	7E
US	1F	?	3F	-	5F	DEL	7F

## Explanation of Terms

### ■ Luster scan

Luster scan is a system to scan plural laser beams toward the bar code height direction as shown in the figure.



### ■ Number of conformance (number of verification)

Decode several times and verify if the results conform. When it conforms for the number of the conformance set beforehand, it is output to RS-232C interface. Number of conformance should be at least twice (number of verification is once) to increase reliability.

### ■ Narrow bar (slim bar)

The narrower bar in the bar code consists with horizontal bars is called a "narrow bar". The narrow bar should be wider than the minimum resolution which the bar code reader can resolve, to read it.

The thicker bar than the narrow bar is called a wide bar (thick bar).

### ■ Parity

This is a means to prevent communication error.

"Parity check" is a data check system which adds 1 bit to data and to have the total bit of "1" either in even number or odd number. The added 1 bit at this time is called "parity bit".

## ■ Modulus check

This is a method to increase bar code reading reliability.

Numerical character or character obtained by specific calculating formula is applied to the end of the data you want to express (also expressed as C/D: check digit in this manual).

After reading a barcode, check the C/D with this calculating formula to avoid reading failure. General check systems are the following three types.

System	Used barcode
Modulus 10/3	Used for barcodes with only numbers. Mainly used for EAN and ITF.
Modulus 43	Used for barcodes including alphabet. Mainly used for CODE39.
Modulus 16	Mainly used for Codabar(NW-7).

### ■ Calculation method of modulus 10/3 weight

1. Add the digits in the even positions (the rightmost character is the 1st digit), and multiple it by 3.
2. Add up the odd numbers (excluding the rightmost check digit) in the data digit.
3. Add values of above clauses **1** and **2**, and add to the unit digit.
4. The check digit is the remainder of 10 minus first digit of clause **3**.

[E.g.] When the bar code data is 4901234 (JAN-8)

$$\begin{array}{r}
 \begin{array}{cccccccc}
 & 4 & 9 & 0 & 1 & 2 & 3 & 4 \\
 \hline
 \text{Even digit} & 4 & + & 0 & + & 2 & + & 4 & = & 10 & 10 \times 3 = & 30 \\
 \text{Odd digit} & & 9 & + & 1 & + & 3 & & = & 13 \\
 \hline
 & 30 & + & 13 & = & 43 & \text{(1st digit is 3)} \\
 & 10 & - & 3 & = & 7 & \bullet\bullet\bullet\text{Check digit}
 \end{array}
 \end{array}$$

Therefore, data with check character is "49012347".

- Calculation method of modulus 43

1. Allocate the value indicated in table 1 in each data character in a symbol.
2. Add all the data character and divide by 43.
3. The remainder calculated in clause 2 is the check character shown in Table 1.

Table 1: Character value calculated in Modulus 43

Character	Value	Character	Value	Character	Value
0	0	F	15	U	30
1	1	G	16	V	31
2	2	H	17	W	32
3	3	I	18	X	33
4	4	J	19	Y	34
5	5	K	20	Z	35
6	6	L	21	"	36
7	7	M	22	,	37
8	8	N	23	SPACE	38
9	9	O	24	\$	39
A	10	P	25	/	40
B	11	Q	26	+	41
C	12	R	27	%	42
D	13	S	28		
E	14	T	29		

[E.g.] When message "CODE39" is indicated in CODE39

C	O	D	E	3	9
↓	↓	↓	↓	↓	↓

Numerical conversion  $12 + 24 + 13 + 14 + 38 + 3 + 9 = 113$

$113 / 43 = 2$  Remainder 27 (Character of 27 is R)  
R ... Check digit

Therefore, data with check character is "CODE39R".

- Calculation method of modulus 16
- 1.** Allocate the value indicated in table 2 to the symbol character.
  - 2.** Add all the message character (including start/stop character) and divide by 16.
  - 3.** When the remainder is 0, check character is 0.  
In other cases, take the remainder value from 16 and the result is the check character value.
  - 4.** Result of clause **3** is the check character value shown in table 2.

Table 2: Character value calculated in Modulus 16

Character	Value	Character	Value
0	0	•	10
1	1	\$	11
2	2	:	12
3	3	/	13
4	4	,	14
5	5	+	15
6	6	A	16
7	7	B	17
8	8	C	18
9	9	D	19

[E.g.] When "A37859B" is indicated in Codabar

A   3   7   8   5   9   B  
↓   ↓   ↓   ↓   ↓   ↓   ↓

Numerical conversion 16 + 3 + 7 + 8 + 5 + 9 + 17 = 65

65 / 16 = 4 Remainder 1 (Character of 1 is +)  
+ ... Check digit

Therefore, data with check character is "A37859B+".



## ■ PCS

PCS is an abbreviation of "Print Contrast Signal" and is a value of reflectance ratio of space (ground color) and a bar indicated in a calculation formula.

PCS can be calculated by the following formula.

$$PCS = \frac{RL - RD}{RL}$$

- RD: Reflection ratio of a bar
- RL: Reflection ratio of ground color (space)

The PCS of this bar code reader is 0.45 or more. (However, ground color reflection ratio is 85 %.)

When expressing PCS, the above formula only may be a relative value. Ground color (space) reflection ratio condition is required to specify to recognize as an absolute value.

## ■ MRD

MRD is an abbreviation of "Minimum Reflectance Difference", indicating contrast of bars and spaces. MRD can be calculated by the following formula.

$$MRD = RL - RD$$

- RD: Reflection ratio of a bar
- RL: Reflection ratio of ground color (space)

The MRD of this bar code reader is 32 % or more. (However, ground color reflection ratio is 85 % or more.)

## ■ RS/CS control

Control system to communicate data between the bar code reader and the upper equipment. Data is transmitted while verifying to hardware through RS/CS line "whether to transmit or not".

## ■ GS1-128 (Reading specification)

The head of GS1-128 data always starts with "Start code" + "FNC1".

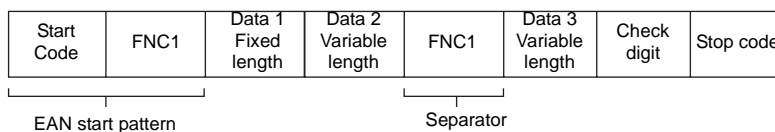

When "Only GS1-128 reading is allowed (G6)" is set, codes other than this combination may be read error.

When "All reading allowed including EAN (G5)" is set, CODE128 other than this combination can be read.

Start pattern of GS1-128 is converted to "C1" (5Dh43h31h in ASCII code) and output. "FNC1" (separator) indicating data separation is converted to "GS" and output.

# Corresponding Bar Code List

- Bar code
  - EAN, UPC



- CODE39



- Industrial2of5(STF)

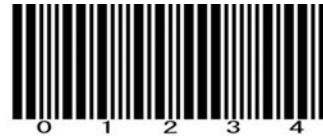

- Codabar(NW-7)



- CODE93



- ITF



- CODE128



■ GS1 DataBar (RSS)

- GS1 DataBar Omni-directional



- GS1 DataBar Truncated



- GS1 DataBar Stacked



- GS1 DataBar Limited



- GS1 DataBar Expanded



## Index

**A**

ACK/NAK system	40, 82
AND verification	69
ASCII code	130

**B**

Bar code	11, 22
Buzzer	75

**C**

C/D	64
Check digit	64
Communication conditions	80
Communication link unit	
Command specification	115
Connecting cable	127
Error code	121
information	106
LED	106
Troubleshooting	120
Communication protocol	82
Communication speed	80
Communication time	41
Consumption current	22
Continuous reading	36, 70
Curvature	26

**D**

Data length	81
Decoding failure	73
DIP-SW	109
Direct code designation	85

**E**

Effective duration	36
Effective duration designation	
system	36
End setting	57
External dimension figure	124
External trigger signal	31, 36, 57

**F**

Factory default setting	58
Failed reading	73
Flow chart	37
Footer	83
Frame	72
Full-time reading	36

**G**

GS1 DataBar (RSS)	137
GS1 DataBar Expanded	137
GS1 DataBar Limited	137
GS1 DataBar Omni-directional	137
GS1 DataBar Stacked	137
GS1 DataBar Truncated	137

**H**

Header	83
Height	11

**I**

ID connection port	114
Immediate transmission system	109
Initial setting	58
Input circuit	31
Input command	54
Installation	33

**L**

Label	11
Label registration	79
LED	
Operation indication lamp of the	
link unit	106
READ OK	21
Luster scan	131

**M**

Machine No.	109
Margin	11
Menu sheet	52
Modulus check	132
Mounting bracket	33
Moving direction	44
MRD	135
Multi-connection port	112
Multi-drop	102
Communication format	105
Flow chart	104

**N**

Narrow bar	11, 131
No label	73
No protocol system	40, 82
Nonprocedural system	40
Nonvolatile memory	57
Number of conformance	131
Number of digits	84
Number of reading digits	22, 74
Number of verification	131

**O**

Output circuit	32
Output format	46

**P**

Parity	81, 131
PC	98
Connecting cable	126
PCS	135
Pitch angle	22, 25
Plural reading	36, 70
Plural reading reset time	72
Polling	107, 116
Positive logic	31
Power supply	31
Programmable controller	99
Connecting cable	125
Protocol	40, 82

**R**

READ NG output	30
READ OK LED	75
READ OK output	30
READ OK signal	77
Reading angle	25
Reading coincidence	69
Reading failed	46
Reading operation	36, 70
Reading permission/prohibition	62
Reading range	24
Reading rate measurement mode	48
Reading system	36
Reading time	41
Reading trigger	45
Reading valid time	70
Reading window	21
Ready/Busy system	82
RS/CS control	135
RS-232C command	36

**S**

SCAN button	21, 36
Single reading	36, 70
Skew angle	22
Slim bar	131
ST/SP	64
Start code	64
Start setting	57
Stop bit	81
Stop code	64

**T**

Termination resistance	118
Test reading	48
Through	109
Tilt angle	22, 26
Timing chart	41
Transmission procedure	109
Trigger controlled system	36
Trigger input method	36
Trigger reading	36
Troubleshooting	
Communication link unit	120
Reading	129

**U**

Upper connection port	110
-----------------------	-----

**W**

Width	11
-------	----

# Revision History

---

A manual revision code appears as a suffix to the catalog number at the bottom of the front and back covers.

Cat. No. Z334-E1-01A

↑  
Revision code

Reprint code	Date	Revised contents
01	January 2013	Original production
01A	March 2013	Minor corrections



**OMRON Corporation Industrial Automation Company**

Tokyo, JAPAN

Contact: [www.ia.omron.com](http://www.ia.omron.com)

*Regional Headquarters*

**OMRON EUROPE B.V.**

**Sensor Business Unit**

Carl-Benz-Str. 4, D-71154 Nufringen, Germany  
Tel: (49) 7032-811-0/Fax: (49) 7032-811-199

**OMRON ELECTRONICS LLC**

One Commerce Drive Schaumburg,  
IL 60173-5302 U.S.A.  
Tel: (1) 847-843-7900/Fax: (1) 847-843-7787

**OMRON ASIA PACIFIC PTE. LTD.**

No. 438A Alexandra Road # 05-05/08 (Lobby 2),  
Alexandra Technopark,  
Singapore 119967  
Tel: (65) 6835-3011/Fax: (65) 6835-2711

**OMRON (CHINA) CO., LTD.**

Room 2211, Bank of China Tower,  
200 Yin Cheng Zhong Road,  
PuDong New Area, Shanghai, 200120, China  
Tel: (86) 21-5037-2222/Fax: (86) 21-5037-2200

**Authorized Distributor:**

© OMRON Corporation 2012 All Rights Reserved.  
In the interest of product improvement,  
specifications are subject to change without notice.

**Cat. No. Z334-E1-01A**

0113