

Confocal fiber displacement sensor

ZW Series



- Robust sensor head structure
- Compact (24x24x64 mm) & Lightweight (105 g)
- Stable measurement for any material

Goes beyond traditional displacement sensor concepts with a new confocal principle.

Displacement Sensors are indispensable in non-contact measurement of heights, thicknesses, and other dimensions in machine operation control. However, building them into the system has always presented problems. The Confocal Fiber Displacement ZW Series Sensor solves these problems in ways that were not possible with traditional triangulation. The ZW-series Sensors provide the compact size, light weight, immunity to electrical/magnetic noise, and other features to make them ideal for solving installation space problems. And OMRON's new confocal principle provides the measurement resolution that is needed for operation control. The ZW Series solves the problems that came with laser triangulation, such as deviations between different materials and inclination tolerance.

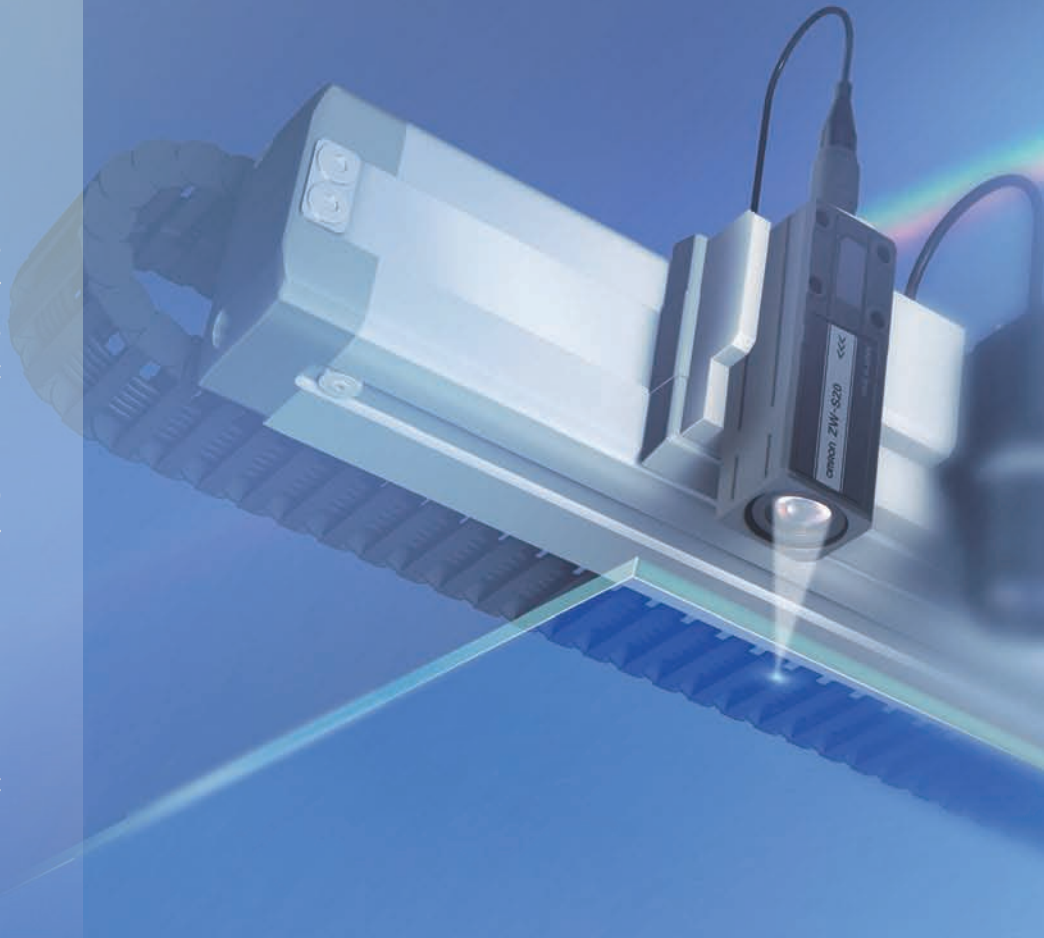

Two Types of Sensor Heads

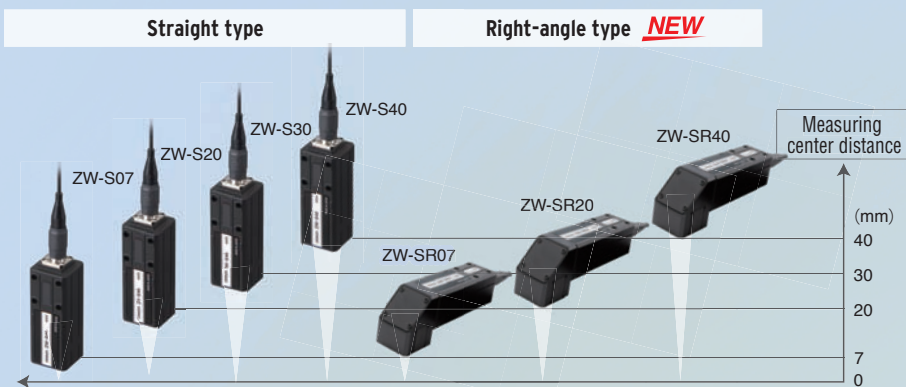

Expanded Communications

Standard-feature
EtherCAT

> p.10

Standard-feature EtherNet/IP™



The Three Benefits of OMRON's White Light Confocal Principle



Ultra-compact and Ultra-lightweight

The slim design measures only 24 × 24 mm. It weighs only 105 g. This incredibly compact size could not be achieved with traditional triangulation. Any objects can be measured with the Sensor mounted perpendicular to them to save even more space.

> P.4

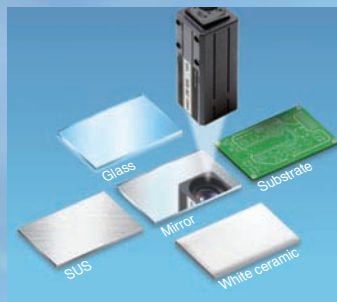

Stable Measurements for Any Material

You can measure objects of any material or color at the same position. A wide angle characteristic of $\pm 8^\circ$ enables high-resolution measurement of the position even for large objects with mirror-like surfaces without being affected by warping.

> P.6

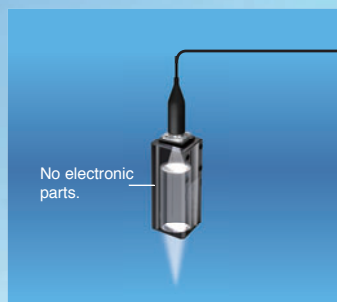

Robust Sensor Head Structure

The sensor head design maintains reliable operation in installations with electronic and magnetic noise. Devices in close proximity will not be affected by noise or heat from the sensor head or fiber cables due to their advanced design.

> P.8

Ultra-compact and Ultra-lightweight

Utilize Narrow Spaces in Machines

The 24 × 24-mm Sensor Head fits easily into essentially any machine.

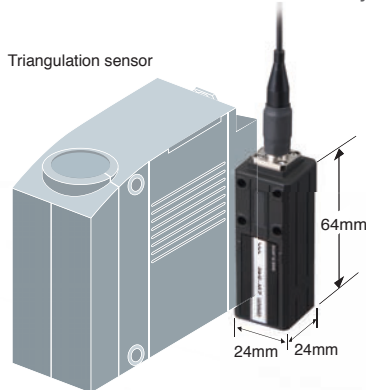

Volume ratio
1/8*

Weight ratio
1/8*

*In-house comparisons.

Mounting area Reduced to 1/7*

*In-house comparison.

With traditional triangulation, it was necessary to use either diffuse reflection or regular reflection depending on the material. However, the confocal principle used for the ZW Series eliminates the need to change the Sensor installation even if the material changes.

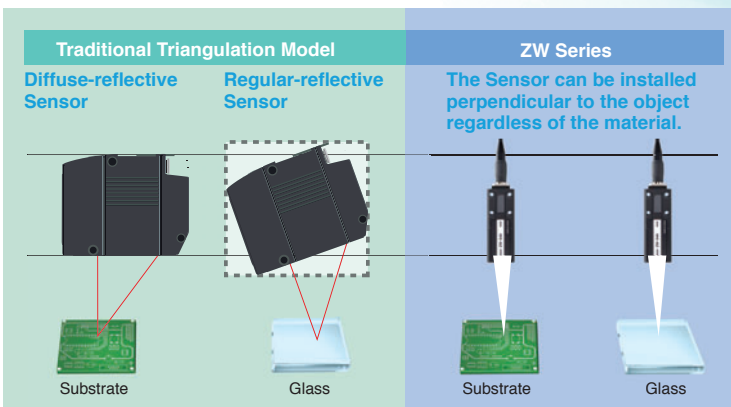

Height Control of a Dispenser Nozzle



Thickness Measurement of a Metal Tube

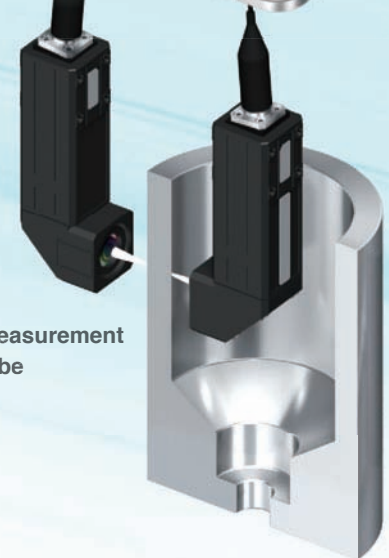

Installation in Tight Spaces

Space restrictions, heat generation, and mutual interference often prevent side-by-side installation of many traditional triangulation sensors. The compact, non-heat generating ZW-series Sensor Head eliminates these problems. Furthermore, the right-angle type Sensor Head can be installed in a limited space over workpieces without a turning mirror.

The traditional sensors generally measure the thickness of a workpiece by calculating the difference between the heights of the stage and the top surface of the workpiece. The ZW-series Sensor Head can be installed in the small space under the stage to directly measure the height from the top and bottom surfaces of the workpiece, which enables more accurate thickness inspection.

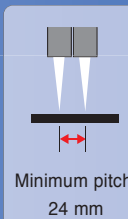

Thickness Inspection of Small Electronic Parts



Smooth Movement and Stopping

Using power cylinders to move sensors to measurement positions only when necessary so that the sensors do not interfere with machine motion resulting in delays in measurements while waiting for settling time if the sensors are heavy. A ZW-series Sensor Head, however, weighs only 105 g so that measurements can be made as soon as the cylinder operation stops.

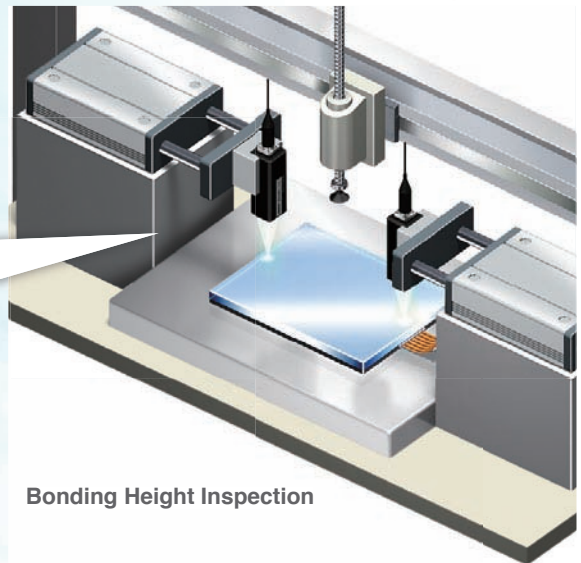
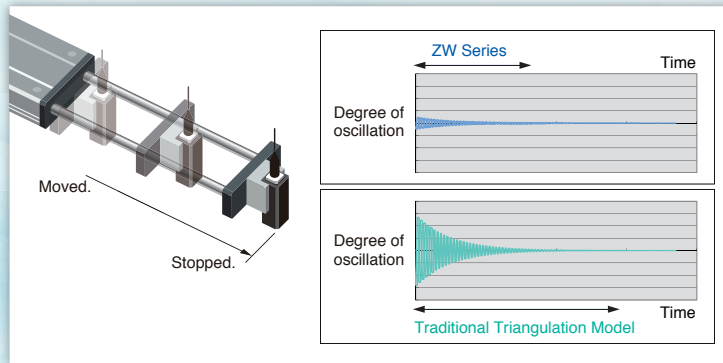

Bonding Height Inspection

Flexible Fiber Cable for Easy Installation

The Controller connects to the Sensor Head with a 2-mm-diameter Flexible Fiber Cable. The Cable has cleared a bending test consisting of 2,000,000* repetitions for reliable application on moving parts.

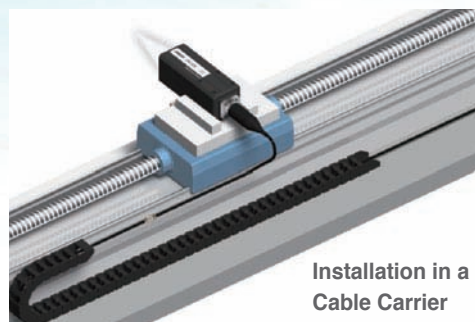

Installation in a Cable Carrier

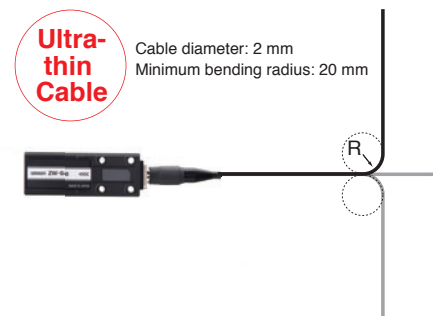

*Cable was tested with OMRON's bending test consisting of 2,000,000 bends to a 70-mm bending radius and 1,000,000 bends to a 20-mm bending radius.

Cable Extendable to 32 m

An Extension Fiber Cable can be used between the Sensor Head and Controller to extend the distance to up to 32 m. Attach the Sensor Head to a moving part and place the Controller in the control panel or other convenient location to achieve a flexible system design.

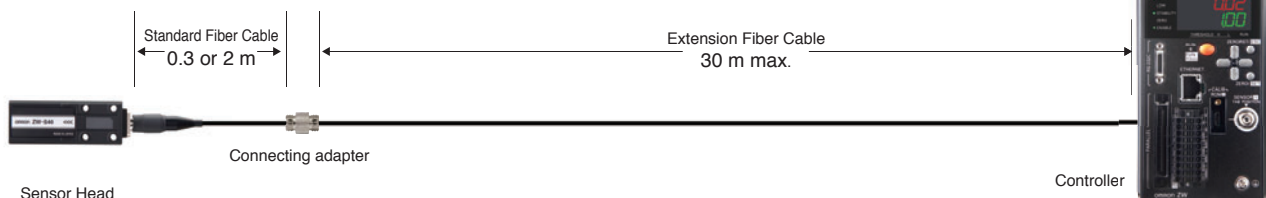

Stable Measurements for Any Material with Superior Angle Characteristic

Stable Measurements from the Same Mounting Position Even for Different Materials

There is no need to change or tune the Sensor for each material. Even if the material changes, you can continue to achieve stable measurements with the same Sensor from the same mounting position.

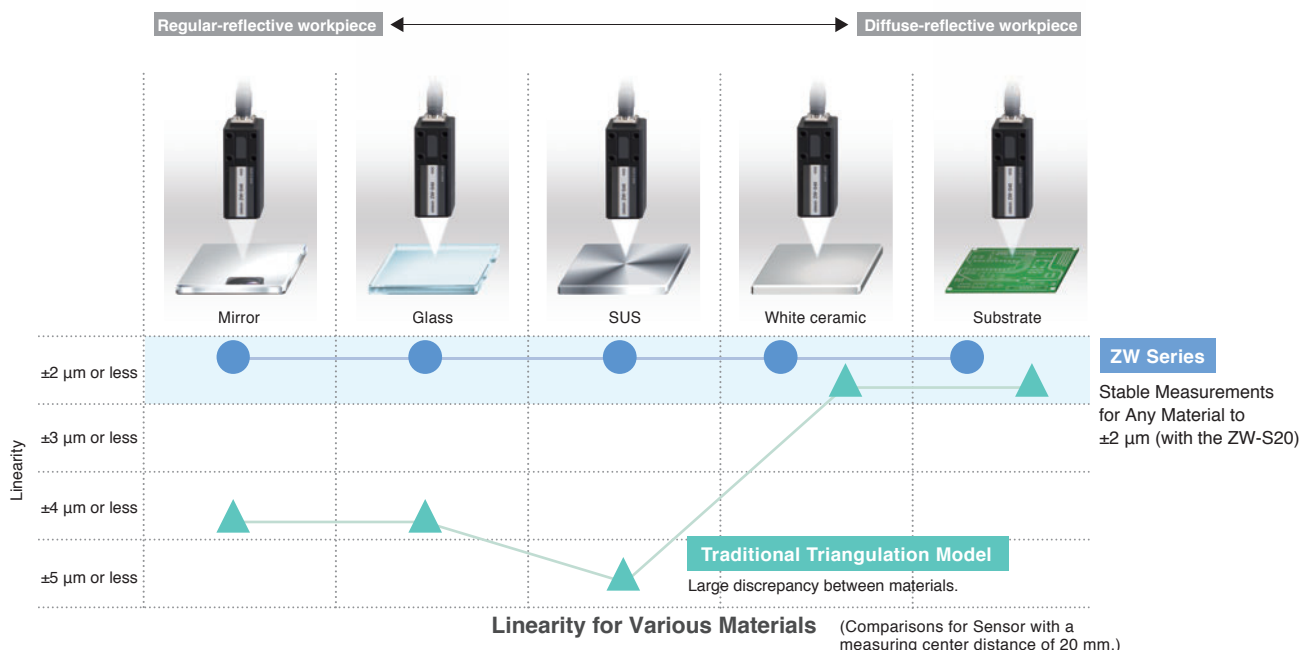

Stable Measurements across Boundaries between Materials

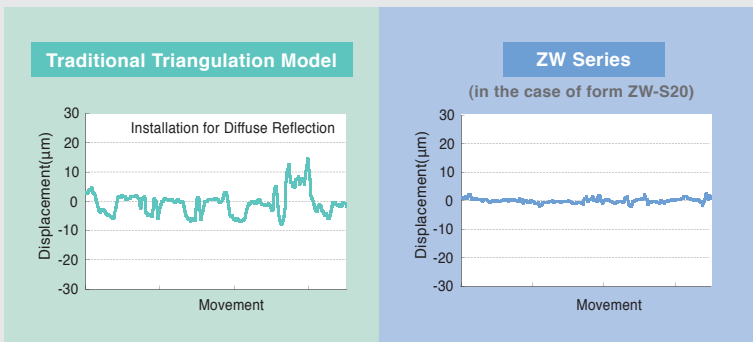

Compact Sensor Heads Provide Stable Measurements of Thin Transparent Glass

To stably measure transparent glass, the received light waveforms from the front and back surfaces of the glass must be separated. With thin transparent glass, the influence of lens aberration makes it difficult to achieve separation with compact sensor heads. Even with its compact size that saves space, the ZW-S07 stably measures transparent surface displacement on glass as thin as $70 \mu\text{m}$ min., a feat not easily achieved by previous compact sensor heads.

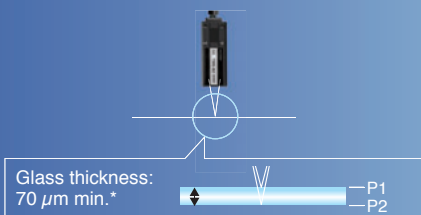

| Model | ZW-S07 | ZW-S20 | ZW-S30 | ZW-S40 |
|----------------------------------------|--------|--------|--------|--------|
| Glass thickness (μm) min. | 70 | 150 | 600 | 900 |
| max. | 900 | 3,000 | 9,000 | 18,000 |

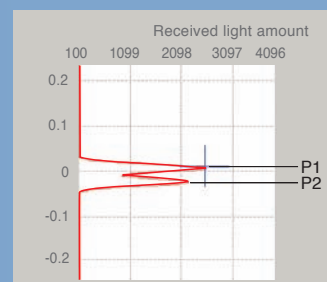

(All measurement graphs represent typical examples.)

Superior Angle Characteristic

When measuring an object that has a mirror-like surface with traditional triangulation, performance is greatly reduced depending on the angle of the Sensor. When many Sensors are used for height control during glass conveyance, the angles of the Sensors must be adjusted with high precision during setup. The confocal Sensor ZW series enables high-resolution measurements without strict angle adjustment. This results in reduction of cost and space for the adjusting jig and time for adjustment.

* This is not a guaranteed value. Refer to Characteristic Data (P23) for typical examples.

Angle characteristic $\pm 8^\circ$ *

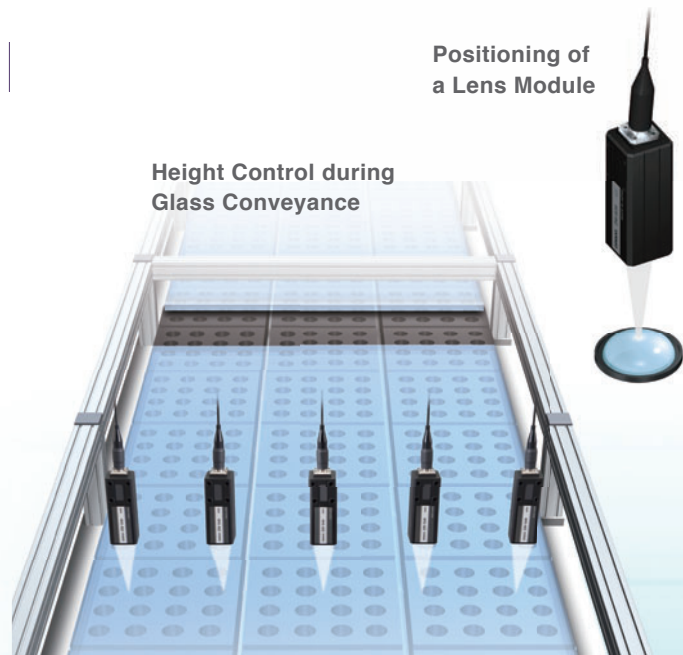

Traditional Triangulation Model

With triangulation, even if the angle is adjusted with high precision during the setup of the Sensor, stable measurement results are difficult to obtain when the measurement object is warped or inclined.

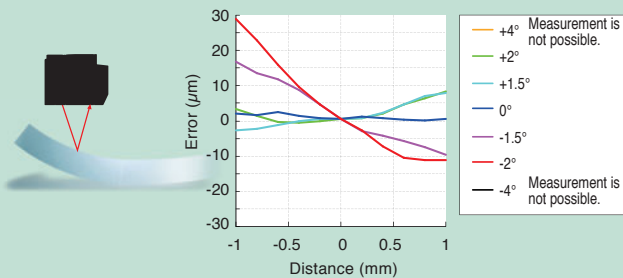

ZW Series

ZW-series Sensors operate on the confocal principle, so high-resolution measurements are possible regardless of inclination and warping of the measurement object.

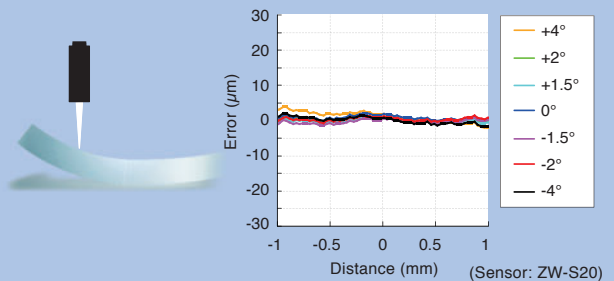

Further Benefits of Confocal Principle

No Discrepancy in the Measurement Point

With triangulation, the measurement position and spot size vary with the height. This means there are times when the position cannot be measured with high resolution due to warping and inclination. With the confocal principle used for the ZW Series, the measurement point remains the same at any position in the measuring range so that precise measurements can always be made.

Measurement in Confined Spaces

When the triangulation sensor measures the inside of a narrow tube or the height of a small depression, the wall often obstructs the reflected light, and the orientation of the sensor and workpiece must be adjusted many times. The ZW Series using the confocal principle can measure the points in narrow spaces or small objects, without changing its installation orientation, because the emitted light and reflected light are positioned along the same axis.

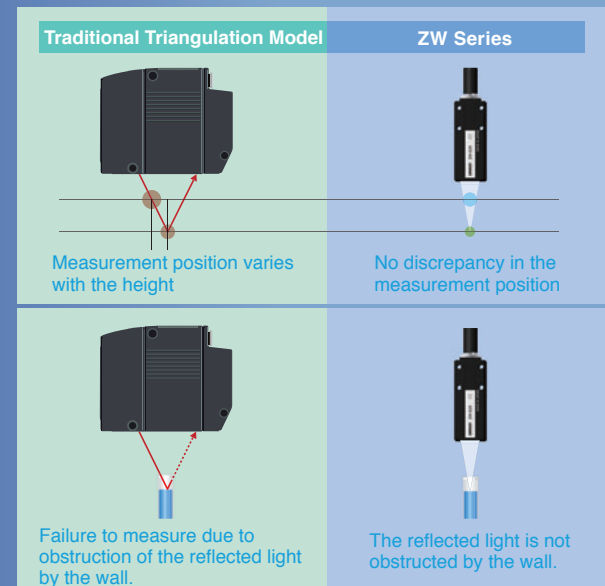

Robust Sensor Head Structure

No Noise

Reduced Work for
EMC Countermeasures

Not Affected by Noise

To ensure high-resolution measurements with normal sensors, countermeasures must be implemented to protect the sensor from the electromagnetic noise that is emitted by any nearby devices. The ZW-series Sensor Heads, however, contain no electronic parts to enable stable measurements even near power sections. Also, the Fiber Cable that connects the Sensor Head to the Controller can be placed near power lines and other cables that emit noise without affecting operation.

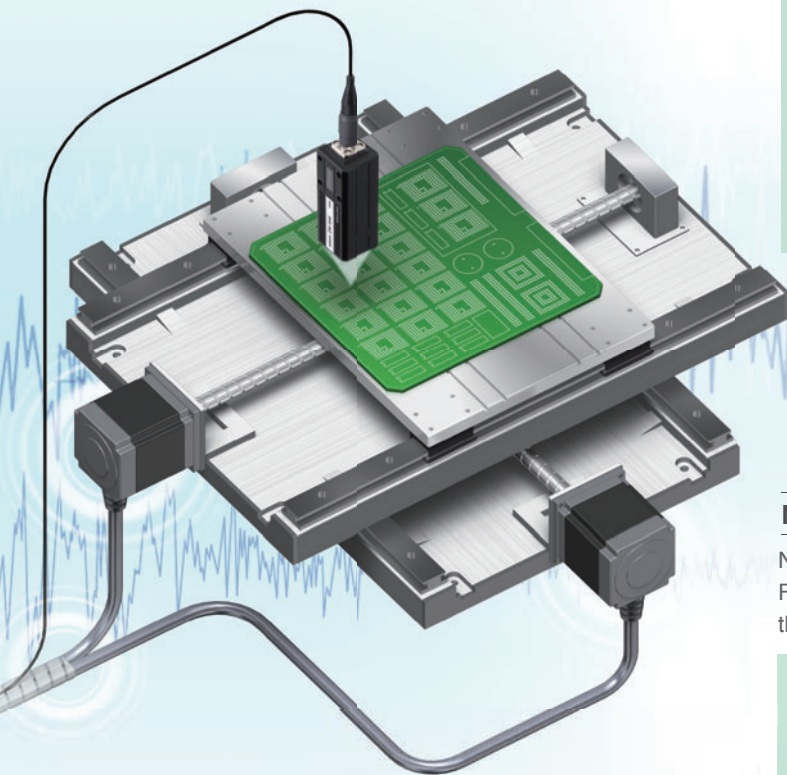

Substrate Height Inspection

Traditional Triangulation Model

Changes in Measurement
Values Caused by Noise

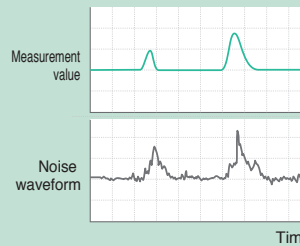

ZW Series

Measurements are not affected by
noise and remain stable.

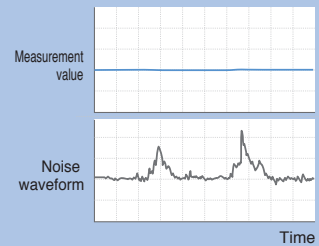

No Noise Emission

No electronic parts are used in the ZW-series Sensor Heads or Fiber Cables, so they give off no electromagnetic noise. You can therefore use them reliably together with other devices.

Traditional Triangulation Model

Electronic parts



Electromagnetic noise is emitted from
the sensor and from cables.

ZW Series

Fiber Cable



No electronic parts.

No Noise Emitted.

No Heat Generation

Reduced Work in Thermal Design

In high-resolution machine control, the heat generated by a sensor head can adversely affect nearby equipment and cause the error to increase. The ZW-series Sensor Heads, however, generate no heat and therefore do not affect nearby equipment. You can also install many Sensor Heads side by side and still be sure of reliable operation.

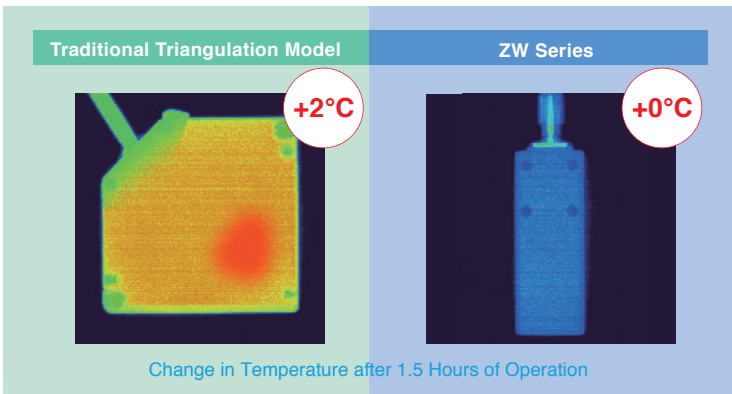

No Electronic Parts

Reduced Maintenance Costs

Displacement sensors are often installed in moving applications and other installations that are subject to vibration. It is important that they can withstand this type of requirement. The ZW series Sensor Heads are designed for this type of environment, they have no electronic parts or PCB's that a standard triangulation sensor contains. The reduction of parts to lenses and fiber cables reduces the maintenance requirements, and the LED light source also eliminates the standard safety measures required for lasers.

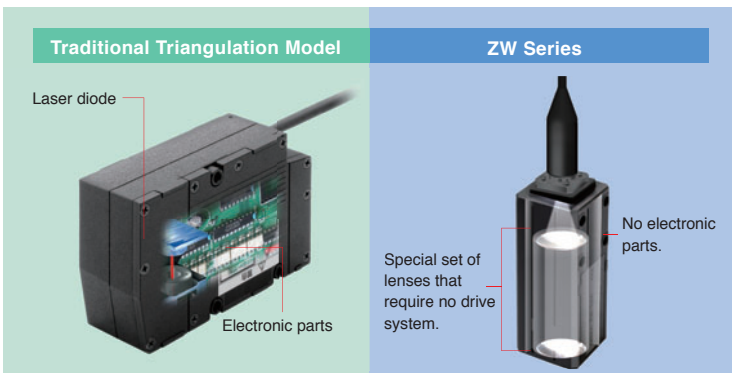

An LED is used in place of a laser for the light source to eliminate the need for safety measures.

Electric circuits and the light source are contained in the Controller.



EtherCAT Machine Control Network

The EtherCAT high-speed open network was optimized for machine control. The ZW-series Sensors are the first OMRON Displacement Sensors with EtherCAT to provide a highly efficient design for high-precision machine control applications that use measurement results to control machine operation.

Combining Height Information and Position Coordinates

EtherCAT can be used to connect to servo drives or encoder input slaves to quickly get the position coordinates and ZW displacement. The height information and XY position coordinates can be easily linked so that the machine control applications can increase processing precision in respect to the height and the inspection applications benefit from maintenance, such as helping to isolate errors or perform trend analysis.

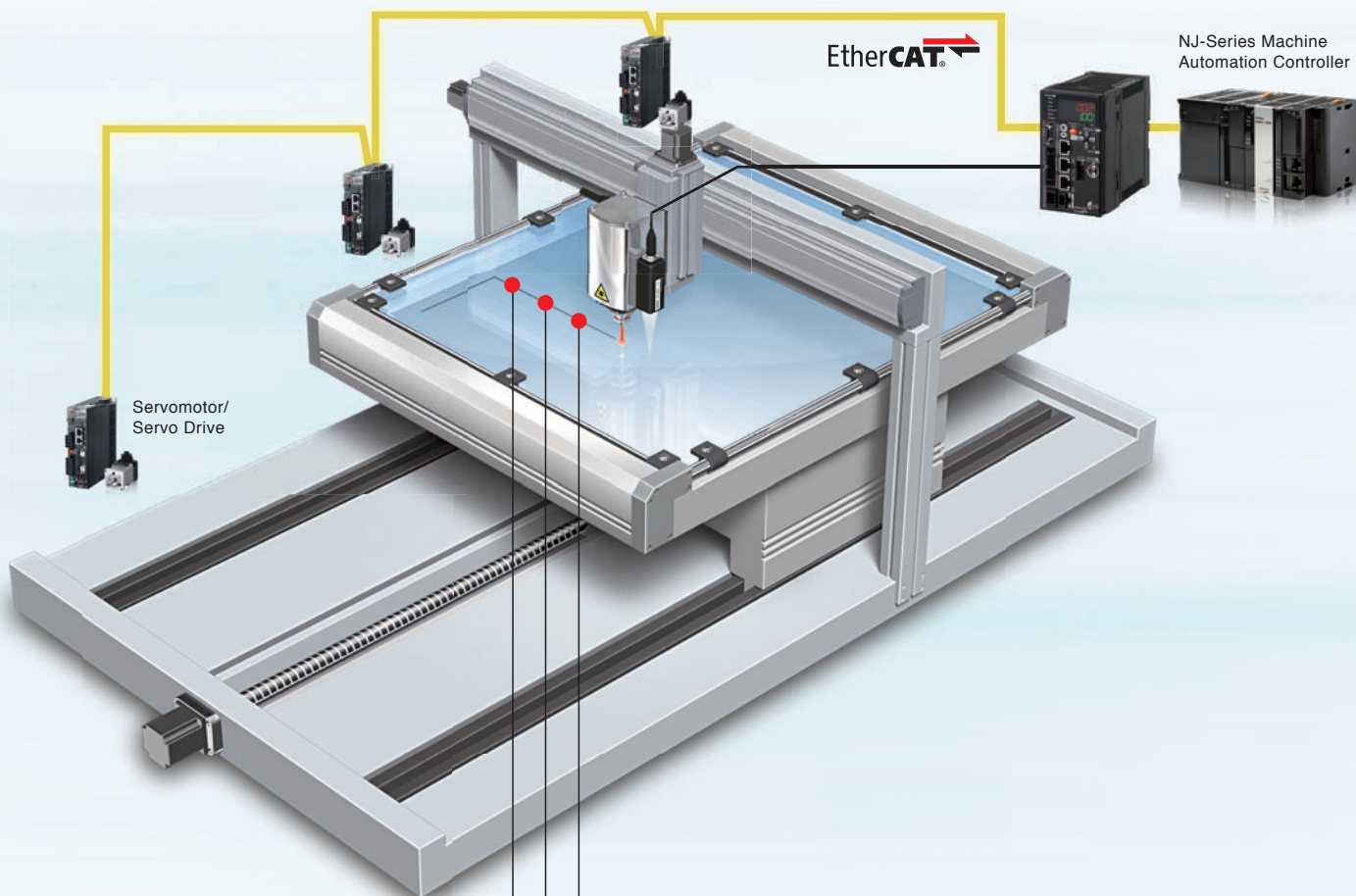

| Measurement point | Measurement result Z | Servo/encoder X | Servo/encoder Y |
|-------------------|----------------------|-----------------|-----------------|
| Point 1 | Z1 | X1 | Y1 |
| Point 2 | Z2 | X2 | Y2 |
| Point 3 | Z3 | X3 | Y3 |
| ⋮ | ⋮ | ⋮ | ⋮ |

Results of Linking with the Position Coordinates

Machine Controls

Increased processing precision

No need for constant-speed control

Inspection Applications

Isolation of errors

Trend management for specific positions

High-speed Digital Output

Shorter Machine Takt Times

With previous digital (serial) outputs through Ethernet or RS-232C, the response period for measurement commands was both inconsistent and slow, making them unsuitable for realtime control. With EtherCAT, a constant period as short as 500 μ s enables continuous digital (serial) outputs so that the overall workpiece height information can be mapped at high speed.

| Previous Serial Output | EtherCAT Output for ZW-series Sensor |
|---------------------------------------------------------------------------------------------------------------------------|-----------------------------------------------------------------------------------------------------------------------------------------------------------------------------------------------------------------------------------------------------------------------------------------------------------------------------------------------------------------------------------------------------------------------|
| <p>The outputs for command inputs required 5 ms or longer and were not consistent.</p> <p>Measurement Commands</p> | <p>Measurement values are output continuously at a fixed period that is as short as 500 μs.</p> <p>Continuous outputs at a period that is as short as 500 μs.</p> <div style="border: 2px solid red; border-radius: 50%; padding: 10px; text-align: center; color: red; font-weight: bold; margin-top: 20px;"> <p>8 Times Faster Than OMRON's Previous Models</p> </div> |

Tracing Machine Movement

Fewer Steps in System Commissioning

You can develop, test, and adjust devices that are connected via EtherCAT with just one Support Software package. The Automation Software Sysmac Studio allows you to creatively design your controls. You can see the entire range from sensing to motion control to reduce the number of steps required to commission the system or to aid in troubleshooting. There are also plenty of offline features to debug signal control programming. You can also simulate machine operation before actual application onsite.

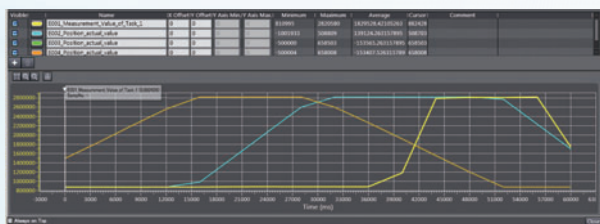

Data Trace

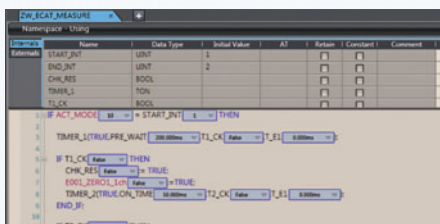

Debugging Control Programming

Note: Sysmac Studio version 1.05 or higher is required for these software interface features described.

Long-distance Wiring: 100 m

Flexible Wiring for Machines

You can use EtherCAT to connect slaves that are up to 100 m apart. With digital communications, error does not occur due to the influences of ambient noise. This solves the previous problems with analog output methods, such as the inability to support long-distance transmissions and noise countermeasures, and enables reliable installation in previously difficult large-scale machines.

- Sysmac is a trademark or registered trademark of OMRON Corporation in Japan and other countries for OMRON factory automation products.
- Windows is registered trademarks of Microsoft Corporation in the USA and other countries.
- Other company names and product names in this document are the trademarks or registered trademarks of their respective companies.
- Microsoft product screen shot(s) reprinted with permission from Microsoft Corporation.

Multipoint Measurement with EtherCAT Concurrency

EtherCAT communications provide both high speed and time-consistent performance so that integrated controls for Sensors and other slaves can be achieved in realtime. Even for multipoint measurements for Displacement Sensor applications, the following advantages are provided.

Reduced Wiring: Only Two Cables Less Wiring for Many Sensors

With previous parallel I/O, manual wiring was required for dozens of points, and it was necessary to take sufficient caution to avoid sources of noise. This required extensive time to use many Displacement Sensors in a row. With EtherCAT, all you have to do is connect two lines for each Controller.

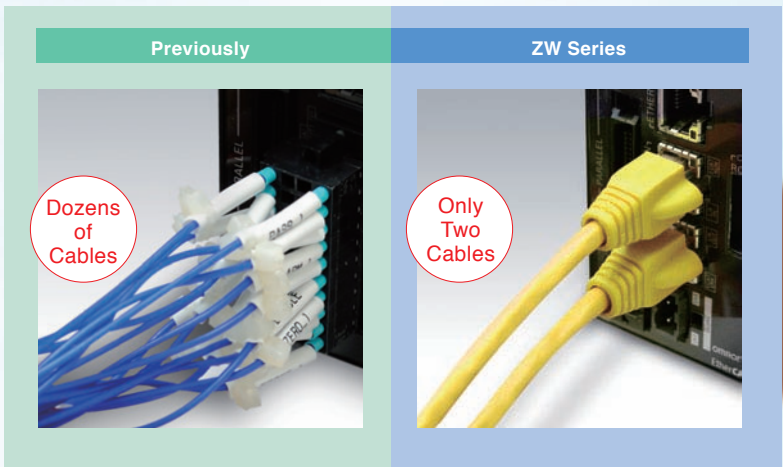

NJ-Series Machine Automation Controller



One Software Fewer Steps in System Design

You can set up all of the slaves that are connected via EtherCAT with just the Automation Software Sysmac Studio. Even when you combine many Sensors, you can copy setup data to effectively integrate setup work or you can easily program calculations between the Sensors.

Sysmac Studio

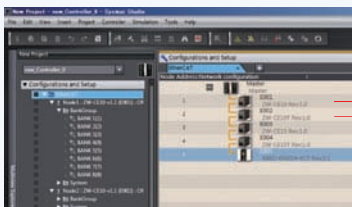

Efficient Setup of Measurement Conditions for Many Sensors

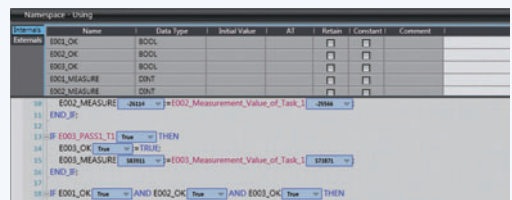
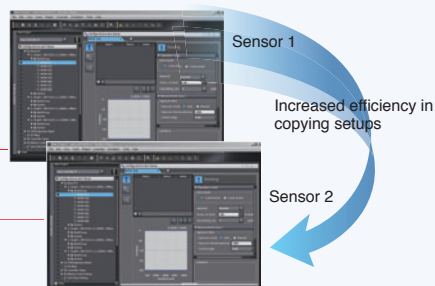

Easy Programming of Thickness Calculations

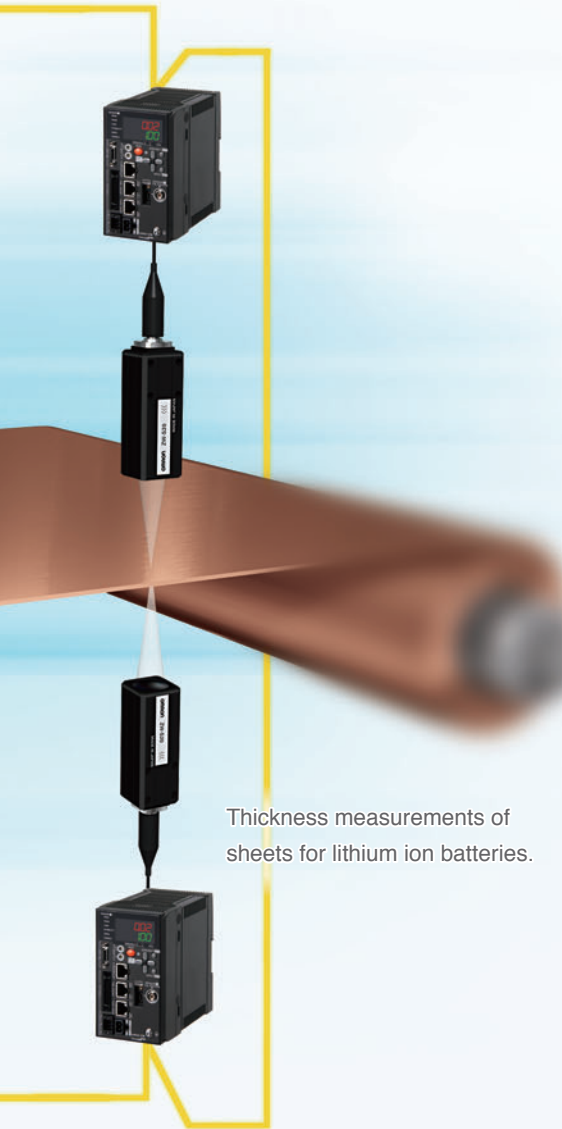

Thickness measurements of sheets for lithium ion batteries.

Synchronous Measurements

Fewer Thickness Errors due to Vibration

The highly precise synchronization performance of EtherCAT reduces the time error in measurements between different Sensors to 1 μ s or less. Synchronous measurement is useful when measurements must be made with more than one Sensor at the same time, such as measurements from both sides of a sheet or inclination control of a substrate.

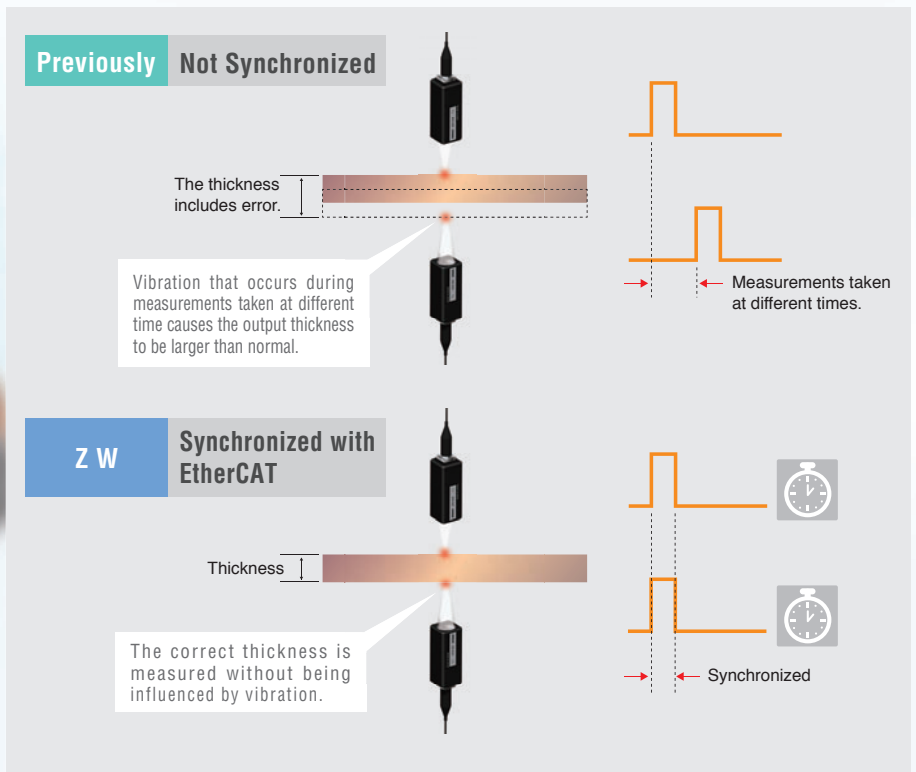

Continuous Measurements of Sheets without Position Offset

When Sensors are installed in a row to continuously log sheet height, nonsynchronous measurements can cause offsets in the lateral measurement positions. With synchronous measurements using EtherCAT, you can continuously log sheet height with all of the Sensors at the same lateral position.

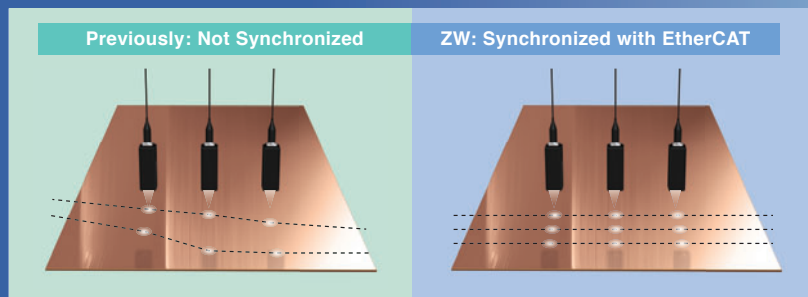

Robust Sensor Head Structure

To achieve a compact Sensor Head and high-resolution measurements, the ZW Series uses a white light confocal principle to detect objects. This principle is described below.

Confocal principle Confocal Light Emission and Reception

Based on the confocal principle, the emitted light and received light are positioned along the same axis. Light is received only when it is focused on the measurement object, allowing the height to be calculated. Unlike triangulation, the received light waveform is not disrupted by the material or inclination of the measurement object. The received light waveform is always stable, which enables high-resolution measurements.

Object Located at Focal Point

The reflected light is focused at the same point as the emitted light. The reflected light becomes the received light signal.

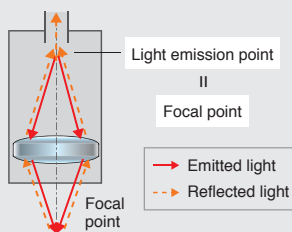

The height is calculated from the position at which the reflected light was received.

Object Not Located at Focal Point

Reflected light is not received because the reflected light is not focused at the light emission point.

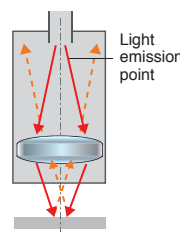

Light is not received.

Inclination and Differences in Materials

Even if the measurement object is inclined or contains different materials, the reflected light will be focused at the light emission point as long as the measurement object is at the focal point.

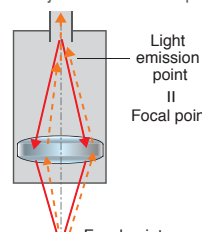

OCFL Module

The OCFL module contains a special lens set developed by OMRON that changes the focal point for each color (i.e., wavelength) of white light. The spot diameter is the same at any position within the measuring range. It does not change the way it does for a triangulation. High-precision lens manufacturing technology has allowed us to achieve a lens structure that is extremely small and that also does not require a drive mechanism.



*OCFL : Omron Chromatic Focus Lens

White Light Separation into Colors with Different Wavelengths at Emission

Patent Pending

The white light from the LED is focused at different points for each color (i.e., wavelength) due to a special set of lenses in the OCFL module in the Sensor Head. As a result, only the color of light that is focused on the measurement object is returned, allowing the distance from the Sensor Head to the measurement object to be calculated based on the color of the reflected light. The Sensor Head contains the special set of lenses that separates white light into different colors and the Controller contains the white LED light source, and the spectroscopy and processor that convert the color of the reflected light to a distance. There is no need for a lens drive mechanism or electronic parts in the Sensor Head, even though they were considered to be standard in previous confocal models. This achieves a much more compact design and much greater immunity to noise than triangulation models and or previous confocal models.

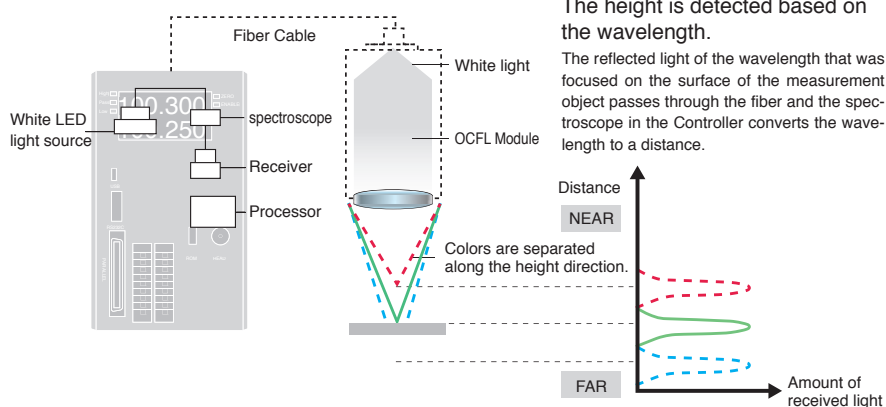

The height is detected based on the wavelength.

The reflected light of the wavelength that was focused on the surface of the measurement object passes through the fiber and the spectroscopy in the Controller converts the wavelength to a distance.

Problems with Previous Models

Triangulation

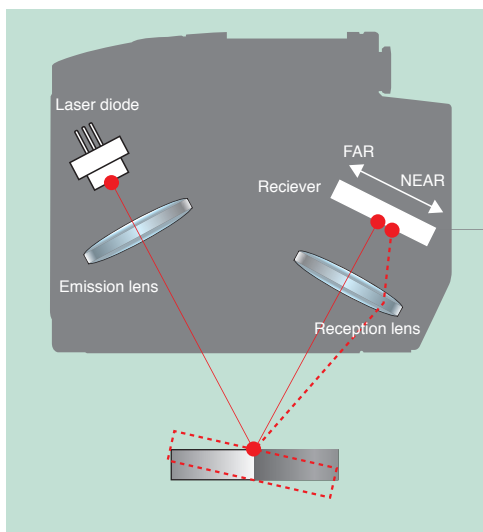

Triangulation measures the height of an object based on the position of the spot on a receiver (CCD or CMOS). The peak, center of gravity, and other features are calculated from the received light waveform to reduce error, but in principle, the received waveform is offset or disrupted due to differences in materials or inclination. This results in measurement error.

Light Reception for Different Materials

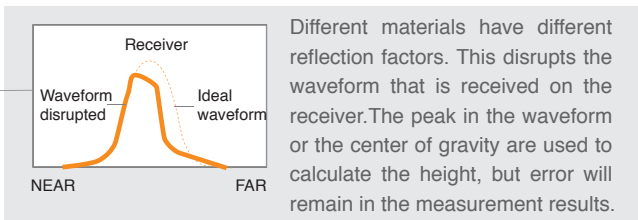

Light Reception for Inclination

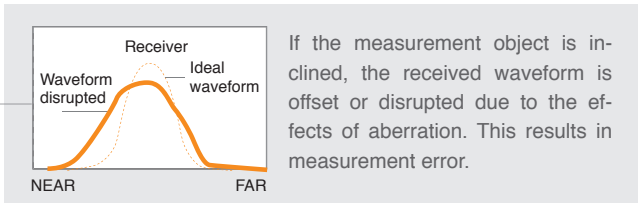

Normal Confocal Principle

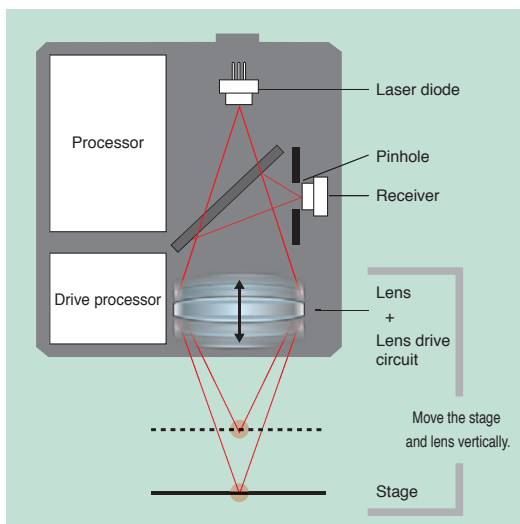

In a normal confocal model, a stage and lens are driven vertically to change the focal point. This requires a more complex structure, and the large number of parts interferes with downsizing. The use of a laser beam increases the chances of interference, and the received light waveform can be disrupted by the surface conditions within the small spot on the measurement object.

System Configuration

EtherCAT connections

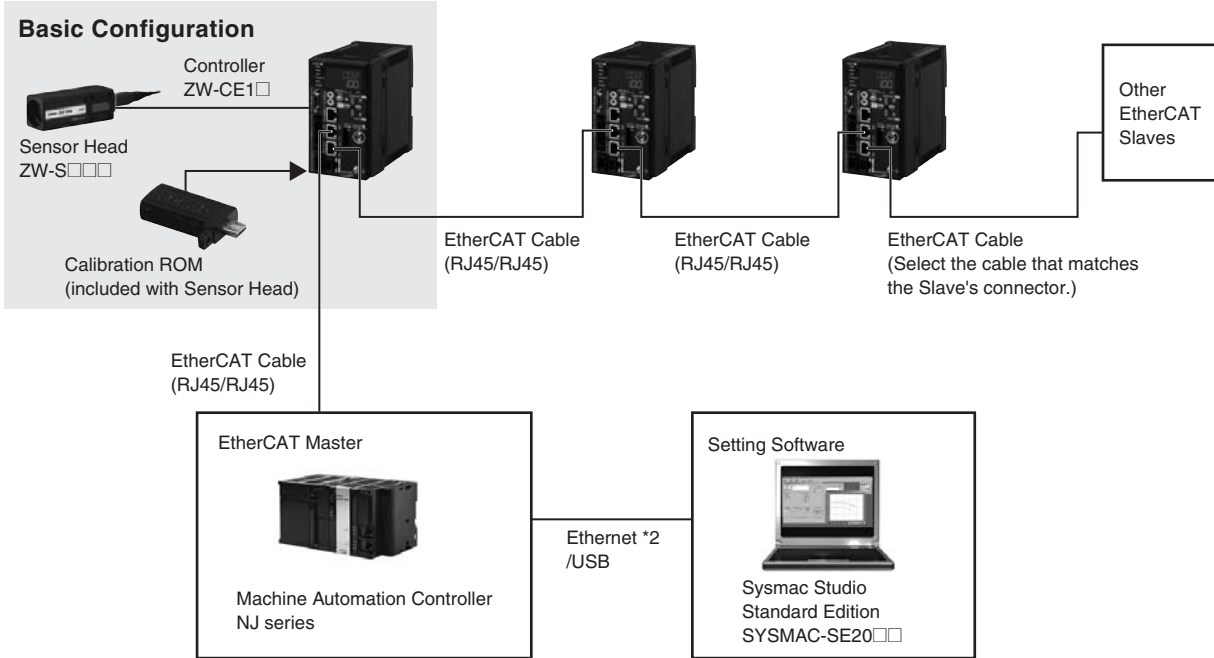

Analog, EtherNet/IP, Ethernet, RS-232C and Parallel connections

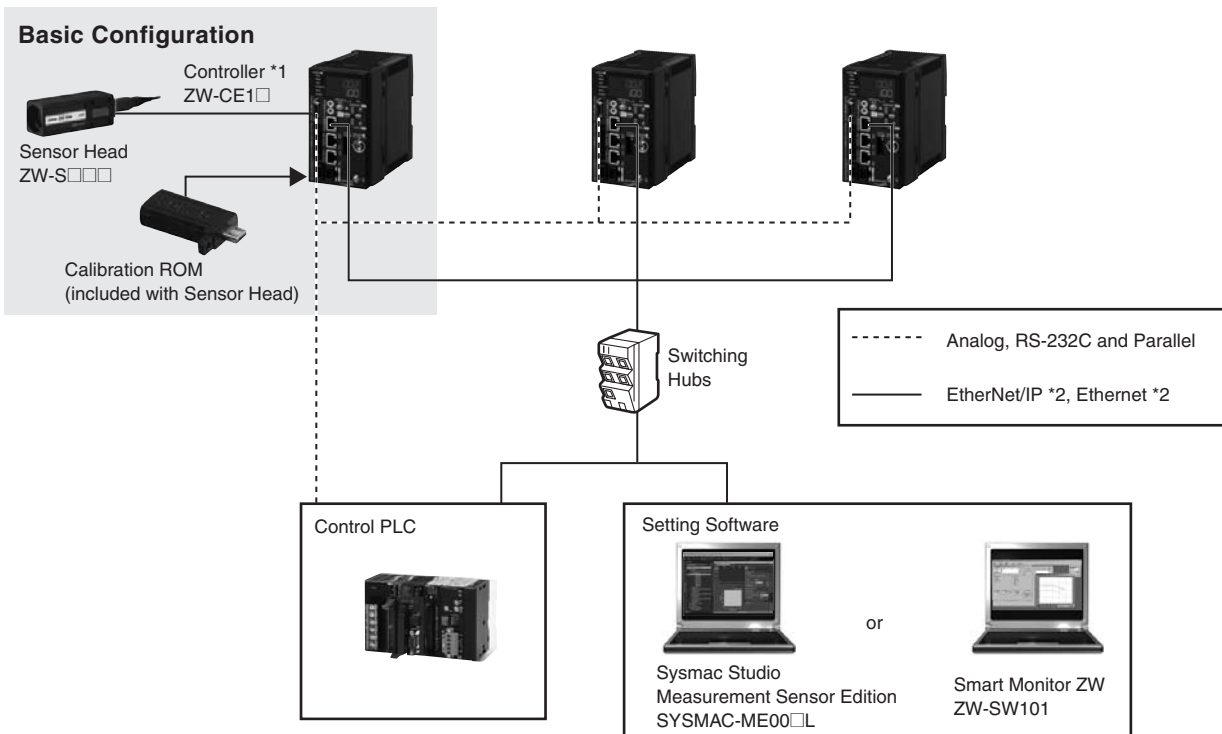

*1 Controllers with binary outputs are also available (ZW-C10T/C15T). Please contact your OMRON sales representative for details.

*2 Prepare commercially available Ethernet cable satisfying the following requirements:

- Category 5e or more, 30 m or less
- RJ45 connector (8-pin modular jack)
- For direct connection: Select cross cable.
- For connection through an industrial switching hub: Select straight cable.

Order Information

● Sensor Head

Straight type

Right-angle type **NEW**

| | ZW-S07 | ZW-S20 | ZW-S30 | ZW-S40 | ZW-SR07 | ZW-SR20 | ZW-SR40 |
|-------------------|---------------|---------------|---------------|---------------|----------------|----------------|----------------|
| Measuring range: | 7±0.3mm | 20±1mm | 30±3mm | 40±6mm | 7±0.3mm | 20±1mm | 40±6mm |
| Spot diameter | 18μm dia. | 40μm dia. | 60μm dia. | 80μm dia. | 18μm dia. | 40μm dia. | 80μm dia. |
| Static resolution | 0.01μm | 0.02μm | 0.06μm | 0.08μm | 0.25μm | 0.25μm | 0.25μm |
| Model | ZW-S07 | ZW-S20 | ZW-S30 | ZW-S40 | ZW-SR07 | ZW-SR20 | ZW-SR40 |

Note: When ordering, specify the cable length (0.3 m, 2.0 m).

● Controller with EtherCAT

| Appearance | Power supply | Output type | Model |
|------------|--------------|-------------|-----------------|
| | DC24V | NPN | ZW-CE10T |
| | | PNP | ZW-CE15T |

Note: Controllers with binary outputs are also available (ZW-C10T/-C15T). Please contact your OMRON sales representative for details.

● Cable

| Appearance | Item | Cable length | Model |
|------------|-------------------------------------------------------------------------------------------------|--------------|-----------------|
| | Sensor Head - Controller Extension Fiber Cable (flexible cable) (Fiber Adapter ZW-XFC provided) | 2m | ZW-XF02R |
| | | 5m | ZW-XF05R |
| | | 10m | ZW-XF10R |
| | | 20m | ZW-XF20R |
| | | 30m | ZW-XF30R |
| | Fiber Adapter (between Sensor Head pre-wired cable and Extension Fiber Cable) | — | ZW-XFC |
| | Parallel cable for ZW-CE1□T 32-pole* (included with Controller ZW-CE1□T) | 2m | ZW-XCP2E |
| | RS-232C Cable for personal computer | 2m | ZW-XRS2 |
| | RS-232C Cable for PLC/programmable terminal | 2m | ZW-XPT2 |

* A parallel cable for Controllers with binary outputs is also available (ZW-XCP2). Please contact your OMRON sales representative for details.

● Automation Software Sysmac Studio

Please purchase a DVD and required number of licenses the first time you purchase the Sysmac Studio. DVDs and licenses are available individually.

Each model of licenses does not include any DVD.

| Product name | Specifications | Number of licenses | | Media | Model | Standards |
|------------------------------------------------------|----------------------------------------------------------------------------------------------------------------------------------------------------------------------------------------------------------------------------------------------------------------------------------------------------------------------------------------------------------------------------------------------------------------------------|--------------------|-------------|-------|----------------------|-----------|
| | | — (Media only) | 1 license*1 | | | |
| Sysmac Studio Standard Edition Ver.1.□□ *2 | The Sysmac Studio provides an integrated development environment to set up, program, debug, and maintain NJ-series Controllers and other Machine Automation Controllers, as well as EtherCAT slaves. Sysmac Studio runs on the following OS. Windows XP (Service Pack 3 or higher, 32-bit version)/Vista(32-bit version)/7(32-bit/64-bit version)/8(32-bit/64-bit version) | — (Media only) | 1 license*1 | DVD | SYSMAC-SE200D | — |
| | | — | — | — | SYSMAC-SE201L | — |
| Sysmac Studio Measurement Sensor Edition Ver.1.□□ *3 | This software provides functions of the Measurement Sensor Edition. Refer to Sysmac Catalog (P072) for details such as supported models and functions. Sysmac Studio Measurement Sensor Edition is a limited license that provides selected functions required for ZW-series Displacement Sensor settings. Because this product is a license only, you need the Sysmac Standard Edition DVD media to install it. | 1 license | 3 license | — | SYSMAC-ME001L | — |
| | | — | — | — | SYSMAC-ME003L | — |

*1. Multi licenses are available for the Sysmac Studio (3, 10, 30, or 50 licenses).

*2. ZW-series is supported by Sysmac Studio version 1.05 or higher.

*3. The Setting Software Smart Monitor ZW is also available (ZW-SW101). Please contact your OMRON sales representative for details.

● Accessories





| Item | Model |
|-------------------------|---------------|
| Fiber Connector Cleaner | ZW-XCL |

Note: Place orders in units of boxes (contacting 10 units).

●Recommended EtherCAT Communications Cables

Use Straight STP (shielded twisted-pair) cable of category 5 or higher with double shielding (braiding and aluminum foil tape) for EtherCAT.

●Cabel with Connectors

| Item | Appearance | Recommended manufacturer | Cable length(m) *1 | Model |
|------------------------------------------------------------------------------------------------------------------------------------------------------------------------------------|-----------------------------------------------------------------------------------|--------------------------|--------------------|----------------------|
| Standard type Cable with Connectors on Both Ends (RJ45/RJ45) Wire Gauge and Number of Pairs: AWG27, 4-pair Cable Cable Sheath material: LSZH *2 Cable color: Yellow *3 |  | OMRON | 0.3 | XS6W-6LSZH8SS30CM-Y |
| | | | 0.5 | XS6W-6LSZH8SS50CM-Y |
| | | | 1 | XS6W-6LSZH8SS100CM-Y |
| | | | 2 | XS6W-6LSZH8SS200CM-Y |
| | | | 3 | XS6W-6LSZH8SS300CM-Y |
| | | | 5 | XS6W-6LSZH8SS500CM-Y |
| Rugged type Cable with Connectors on Both Ends (RJ45/RJ45) Wire Gauge and Number of Pairs: AWG22, 2-pair Cable |  | OMRON | 0.3 | XS5W-T421-AMD-K |
| | | | 0.5 | XS5W-T421-BMD-K |
| | | | 1 | XS5W-T421-CMD-K |
| | | | 2 | XS5W-T421-DMD-K |
| | | | 5 | XS5W-T421-GMD-K |
| | | | 10 | XS5W-T421-JMD-K |
| Rugged type Cable with Connectors on Both Ends (M12 Straight/RJ45) Wire Gauge and Number of Pairs: AWG22, 2-pair Cable |  | OMRON | 0.3 | XS5W-T421-AMC-K |
| | | | 0.5 | XS5W-T421-BMC-K |
| | | | 1 | XS5W-T421-CMC-K |
| | | | 2 | XS5W-T421-DMC-K |
| | | | 5 | XS5W-T421-GMC-K |
| | | | 10 | XS5W-T421-JMC-K |
| Rugged type Cable with Connectors on Both Ends (M12 Right-angle/RJ45) Wire Gauge and Number of Pairs: AWG22, 2-pair Cable |  | OMRON | 0.3 | XS5W-T422-AMC-K |
| | | | 0.5 | XS5W-T422-BMC-K |
| | | | 1 | XS5W-T422-CMC-K |
| | | | 2 | XS5W-T422-DMC-K |
| | | | 5 | XS5W-T422-GMC-K |
| | | | 10 | XS5W-T422-JMC-K |

Note: For details, refer to Cat.No.G019.

*1. Standard type cables length 0.2, 0.3, 0.5, 1, 1.5, 2, 3, 5, 7.5, 10, 15 and 20m are available.

Rugged type cables length 0.3, 0.5, 1, 2, 3, 5, 10 and 15m are available.

*2. The lineup features Low Smoke Zero Halogen cables for in-cabinet use and PUR cables for out-of-cabinet use.

*3. Cables colors are available in blue, yellow, or Green

●Cables / Connectors

Wire Gauge and Number of Pairs: AWG24, 4-pair Cable

| Item | Appearance | Recommended manufacturer | Model |
|-----------------|------------|------------------------------|----------------------------|
| Cables | — | Hitachi Metals, Ltd. | NETSTAR-C5E SAB 0.5 × 4P * |
| | — | Kuramo Electric Co. | KETH-SB * |
| | — | SWCC Showa Cable Systems Co. | FAE-5004 * |
| RJ45 Connectors | — | Panduit Corporation | MPS588-C * |

* We recommend you to use above cable and connector together.



Wire Gauge and Number of Pairs: AWG22, 2-pair Cable

| Item | Appearance | Recommended manufacturer | Model |
|-------------------------|-------------------------------------------------------------------------------------|------------------------------------|----------------|
| Cables | — | Kuramo Electric Co. | KETH-PSB-OMR * |
| | — | Nihon Electric Wire&Cable Co.,Ltd. | PNET/B * |
| RJ45 Assembly Connector |  | OMRON | XS6G-T421-1 * |

Note: Connect both ends of cable shielded wires to the connector hoods.



* We recommend you to use above cable and connector together.

●Industrial switching hubs for Ethernet

| Appearance | Number of ports | Failure detection | Current consumption | Model |
|-------------------------------------------------------------------------------------|-----------------|-------------------|---------------------|----------|
|  | 3 | None | 0.08A | W4S1-03B |
|  | 5 | None | 0.12A | W4S1-05B |
| | | Supported | | W4S1-05C |

Note: Industrial switching hubs are cannot be used for EtherCAT.

●EtherCAT junction slaves

| Appearance | Number of ports | Power supply voltage | Current consumption | Model |
|-------------------------------------------------------------------------------------|-----------------|-----------------------------------------|---------------------|---------|
|  | 3 | 20.4 to 28.8 VDC (24 VDC -15 to 20%) | 0.08A | GX-JC03 |
|  | 6 | | 0.17A | GX-JC06 |

Note: 1. Please do not connect EtherCAT junction slave with OMRON position control unit, Model CJ1W-NC□81/□82.

2. EtherCAT junction slaves cannot be used for EtherNet/IP™ and Ethernet.

Specifications

● Sensor Head

| Item | ZW-S07 | ZW-S20 | ZW-S30 | ZW-S40 | ZW-SR07 | ZW-SR20 | ZW-SR40 |
|-----------------------------------------|---------------------------------------------------------------------------------------------|--------------------------|--------------------------|--------------------------|---------------------------|--------------------------|--------------------------|
| Measuring center distance | 7 mm | 20 mm | 30 mm | 40 mm | 7 mm | 20 mm | 40 mm |
| Measuring range | ±0.3 mm | ±1 mm | ±3 mm | ±6 mm | ±0.3 mm | ±1 mm | ±6 mm |
| Static resolution *1 | 0.25 μm | 0.25 μm | 0.25 μm | 0.25 μm | 0.25 μm | 0.25 μm | 0.25 μm |
| Linearity *2 | ±0.8 μm | ±1.2 μm | ±4.5 μm | ±7.0 μm | ±1.1 μm | ±1.6 μm | ±9.3 μm |
| Spot diameter *3 | Near | 20 μm dia. | 45 μm dia. | 70 μm dia. | 90 μm dia. | 20 μm dia. | 45 μm dia. |
| | Center | 18 μm dia. | 40 μm dia. | 60 μm dia. | 80 μm dia. | 18 μm dia. | 40 μm dia. |
| | Far | 20 μm dia. | 45 μm dia. | 70 μm dia. | 90 μm dia. | 20 μm dia. | 45 μm dia. |
| Measuring cycle | 500 μs to 10 ms | | | | | | |
| Operating ambient illumination | Illumination on object surface 10,000 lx or less: incandescent light | | | | | | |
| Ambient temperature range | Operating: 0 to 50°C, Storage: -15 to 60°C (with no icing or condensation) | | | | | | |
| Ambient humidity range | Operating and storage: 35% to 85% (with no condensation) | | | | | | |
| Degree of protection | IP40 (IEC60529) | | | | | | |
| Vibration resistance (destructive) | 10 to 150 Hz, 0.35 mm single amplitude, 80 min each in X, Y, and Z directions | | | | | | |
| Shock resistance (destructive) | 150 m/s ² 3 times each in six directions (up/down, left/right, forward/backward) | | | | | | |
| Temperature characteristic *4 | 0.6 μm/°C (0.45 μm/°C) | 1.5 μm/°C (1.0 μm/°C) | 2.8 μm/°C (2.0 μm/°C) | 4.8 μm/°C (3.8 μm/°C) | 0.6 μm/°C (0.45 μm/°C) | 1.5 μm/°C (1.0 μm/°C) | 4.8 μm/°C (3.8 μm/°C) |
| Materials | Case: aluminum die-cast Fiber cable sheath: PVC Calibration ROM: PC | | | | | | |
| Fiber cable length | 0.3 m, 2 m (Flex-resistant cable) | | | | | | |
| Fiber cable minimum bending radius | 20 mm | | | | | | |
| Insulation resistance (Calibration ROM) | Between case and all terminals: 20 MΩ (by 250 V megger) | | | | | | |
| Dielectric strength (Calibration ROM) | Between case and all terminals: 1,000 VAC, 50/60 Hz, 1 min | | | | | | |
| Weight | Approx. 105 g (Chassis, fiber cable total) | | | | | | |
| Accessories included with sensor head | Instruction sheet, Fixing screw (M2) for Calibration ROM, Precautions for correct use | | | | | | |

*1. Capacity value when Omron standard mirror surface target is measured at the measurement center distance as the average of 4,096 times.

*2. Material setting for the Omron standard mirror surface target: Error from an ideal straight line when measuring on mirror surface. The reference values for linearity when targets to measure other than the above are as in the table below.

| Item | ZW-S07 | ZW-S20 | ZW-S30 | ZW-S40 | ZW-SR07 | ZW-SR20 | ZW-SR40 |
|---------------|---------|---------|---------|---------|---------|---------|----------|
| Glass | ±1.0 μm | ±1.2 μm | ±4.5 μm | ±7.0 μm | ±1.1 μm | ±1.6 μm | ±9.3 μm |
| SUS BA | ±1.2 μm | ±1.4 μm | ±5.5 μm | ±8.5 μm | ±1.2 μm | ±1.8 μm | ±9.3 μm |
| White ceramic | ±1.6 μm | ±1.7 μm | ±6.4 μm | ±9.5 μm | ±1.6 μm | ±1.9 μm | ±11.0 μm |

*3. Capacity value defined by $1/e^2$ (13.5%) of the center optical intensity in the measured area.

*4. Temperature characteristic at the measurement center distance when the Sensor Head and the target are fastened with an aluminum jig and the Sensor Head and the Controller are set in the same temperature environment.

Figures in parentheses are converted value obtained by subtracting the effect of expansion or contraction of the aluminum jig itself.

● Automation Software Sysmac Studio

System Requirements

| Item | Requirement |
|----------------------------------------------------------------|----------------------------------------------------------------------------------------------------------------------------------------------------------------|
| Operating system (OS) *1 *2 | Windows XP (Service Pack 3 or higher, 32-bit version)/Vista(32-bit version)/7(32-bit/64-bit version)/8(32-bit/64-bit version) |
| CPU | Windows computers with Celeron 540 (1.8 GHz) or faster CPU. Core i5 M520 (2.4 GHz) or equivalent or faster recommended |
| Main memory | 2 GB min. |
| Recommended videomemory / video card for using 3D motion trace | Video memory: 512 MB min. Video card: Either of the following video cards: • NVIDIA GeForceR 200 Series or higher • ATI RadeonHD5000 Series or higher |
| Hard disk | At least 1.6 GB of available space |
| Display | XGA 1024 × 768, 16 million colors. WXGA 1280 × 800 min. recommended |
| Disk drive | DVD-ROM drive |
| Communications ports | USB port corresponded to USB 2.0, or Ethernet port *3 |
| Supported languages | Japanese, English, German, French, Italian, Spanish, simplified Chinese, traditional Chinese, Korean |

*1. Sysmac Studio Operating System Precaution: System requirements and hard disk space may vary with the system environment.

*2. The following restrictions apply when Sysmac Studio is used with Microsoft Windows Vista or Windows 7.

Some Help files cannot be accessed.

The Help files can be accessed if the Help program distributed by Microsoft for Windows (WinHlp32.exe) is installed. Refer to the Microsoft homepage listed below or contact Microsoft for details on installing the file. (The download page is automatically displayed if the Help files are opened while the user is connected to the Internet.)
<http://support.microsoft.com/kb/917607/en-us>

*3. Refer to the hardware manual for your Controller for hardware connection methods and cables to connect the computer and Controller.

● Setting Software Smart Monitor ZW ZW-SW101

System Requirements

| Item | Condition |
|----------------------|----------------------------------------------------------------------------------------|
| Operating System(OS) | Windows 7 (32 or 64-bit version) Windows XP (Service Pack3 or more, 32-bit version) |
| CPU | Intel Pentium III, 850 MHz or more (2 GHz or more is recommended.) |
| Main memory | 1 GB or more |
| Hard disk | 50 MB or more |
| Display | 1024 × 768 dots or more, 16 million colors or more |
| Supported languages | Japanese/English |
| Communication port | Ethernet port |

● Controller

| Item | ZW-CE10T | ZW-CE15T | |
|--------------------------------------|------------------------------------------------------------------------------------------------------|--------------------------------------------------------------------------------------------------------------------------------------------------------------------------------------------------|--------------------------------------------------------------------------------------------------------------------------------------------------------------------------------------------------|
| Input/Output type | NPN | PNP | |
| Number of connected Sensor Heads | 1 per Controller | | |
| Sensor Head compatibility | Available | | |
| Light source for measurement | White LED | | |
| Segment display | Main display | 11-segment red display, 6 digits | |
| | Sub-display | 11-segment green display, 6 digits | |
| LED display | Status indicators | HIGH (orange), PASS (green), LOW (orange), STABILITY (green), ZERO (green), ENABLE (green), THRESHOLD-H (orange), THRESHOLD-L (orange), RUN (green) | |
| | EtherCAT indicators | L/A IN(Link Activity IN)(green), L/O OUT(Link Activity OUT)(green), ECAT RUN(green), ECAT ERR(red) | |
| External interface | Ethernet | 100BASE-TX, 10BASE-T, No-protocol Communications (TCP/UDP), EtherNet/IP™ | |
| | EtherCAT | EtherCAT-specific protocol 100BASE-TX | |
| | RS-232C | 115,200 bps max. | |
| | Analog output terminal block | Analog voltage output (OUT1V) | -10 V to +10 V, output impedance: 100 Ω |
| | | Analog current output (OUT1A) | 4 mA to 20 mA, maximum load resistance: 300Ω |
| | 32-pole extension connector | Judgment output (HIGH1/PASS1/LOW1) | Transistor output system Output voltage: 21.6 to 30 VDC Load current: 50 mA or less Residual voltage when turning ON: 1.2 V or less Leakage voltage when turning OFF: 0.1 mA or less |
| | | BUSY output (BUSY1) | |
| | | ALARM output (ALARM1) | |
| | | ENABLE output (ENABLE) | |
| | | LED OFF input (LED OFF1) | DC input system |
| | | ZERO RESET input (ZERO) | Input voltage: 24 VDC ·10% (21.6 to 26.4 VDC) Input current: 7 mA Typ. (24 VDC) |
| | | TIMING output (TIMING1) | Voltage/Current when turning ON: 19 V/3 mA or more Voltage/Current when turning OFF:5 V/1 mA or less |
| Bank | Selected bank output (BANK_OUT 1 to 3) | Transistor output system Output voltage: 21.6 to 30 VDC Load current: 50 mA or less Residual voltage when turning ON: 1.2 V or less Leakage voltage when turning OFF: 0.1 mA or less | |
| | Selected bank input (BANK_SEL 1 to 3) | DC input system Input voltage: 21.6 to 26 VDC Input current: 7 mA Typ. (24 VDC) Voltage/Current when turning ON: 19 V/3 mA or more Voltage/Current when turning OFF:5 V/1 mA or less | |
| Main functions | Exposure time | Auto/Manual | |
| | Measuring cycle | 500 μs to 10 ms | |
| | Material setting | Standard/Mirror/Diffusion surfaces | |
| | Measurement item | Height/Thickness/Calculation | |
| | Filtering | Median/Average/Differentiation/High pass/Low pass/Band pass | |
| | Outputs | Scaling/Different holds/Zero reset/Logging for a measured value | |
| | Display | Measured value/Threshold value/Analog output voltage or current value/Judgment result/Resolution/Exposure time | |
| | Number of configurable banks | Max. 8 banks | |
| | Task process | Multi-task (up to 4 tasks per bank) | |
| | System | Save/Initialization/Display measurement information/Communication settings/Sensor Head calibration/Key-lock/Trigger-key input | |
| Ratings | Power supply voltage | 21.6 to 26.4 VDC (including ripple) | |
| | Current consumption | 600 mA max. | |
| | Insulation resistance | Across all lead wires and controller case: 20 MΩ(by 250 V megger) | |
| | Dialectic strength | Across all lead wires and controller case: 1,000 VAC, 50/60 Hz, 1 min. | |
| Environmental | Degree of protection | IP20(IEC60529) | |
| | Vibration resistance (destructive) | 10 to 55 Hz, 0.35-mm single amplitude, 50 min each in X, Y, and Z directions | |
| | Shock resistance (destructive) | 150 m/s ² , 3 times each in six directions (up/down, left/right, forward/backward) | |
| | Ambient temperature | Operating: 0 to 40°C Storage:-15 to 60°C (with no icing or condensation) | |
| | Ambient humidity | Operating and storage: 35% to 85% (with no condensation) | |
| Grounding | D-type grounding (Grounding resistance of 100 Ω or less) Note: For conventional Class D grounding | | |
| Materials | Case: PC | | |
| Weight | Approx. 750 g (main unit only), Approx. 150 g (Parallel Cable) | | |
| Accessories included with controller | Instruction sheet,Member registration sheet, Parallel cable ZW-XCP2E | | |

Note: Controllers with binary outputs are also available (ZW-C10T/-C15T). Please contact your OMRON sales representative for details.

● ZW Series EtherCAT Communications Specifications

| Item | Specification |
|-------------------------|-----------------------------------------------------------------------------------------------|
| Communications standard | IEC61158 Type12 |
| Physical layer | 100BASE-TX(IEEE802.3) |
| Connectors | RJ45 × 2 ECAT IN: EtherCAT input ECAT OUT: EtherCAT output |
| Communications media | Category 5 or higher (cable with double, aluminum tape and braided shielding) is recommended. |
| Communications distance | Distance between nodes: 100 m max. |
| Process data | Variable PDO mapping |
| Mailbox (CoE) | Emergency messages, SDO requests, SDO responses, and SDO information |
| Distributed clock | Synchronization in DC mode. |
| LED display | L/A IN (Link/Activity IN) × 1, AL/A OUT (Link/Activity OUT) × 1, AECAT RUN × 1, AECAT ERR × 1 |

Characteristic data (typical examples)

Linearity Characteristic by Materials

Straight type

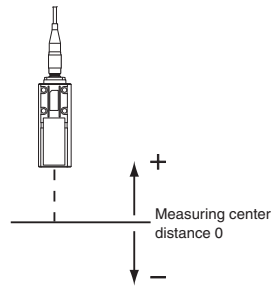

ZW-S07

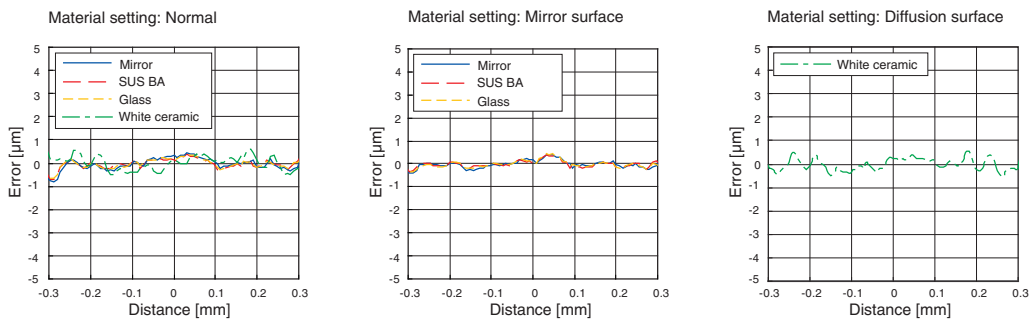

ZW-S20

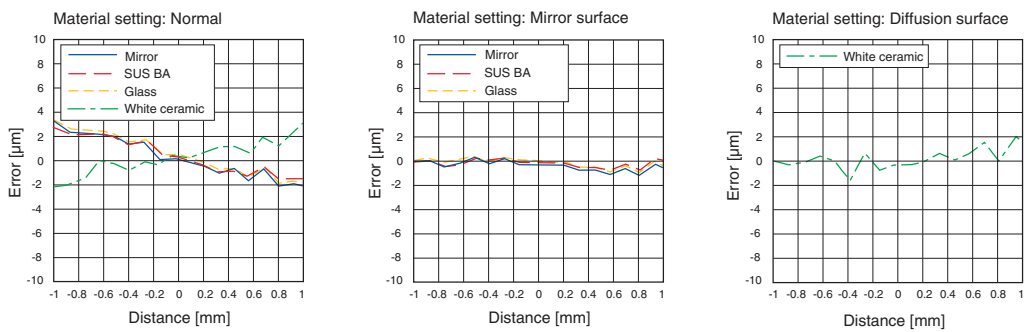

ZW-S30

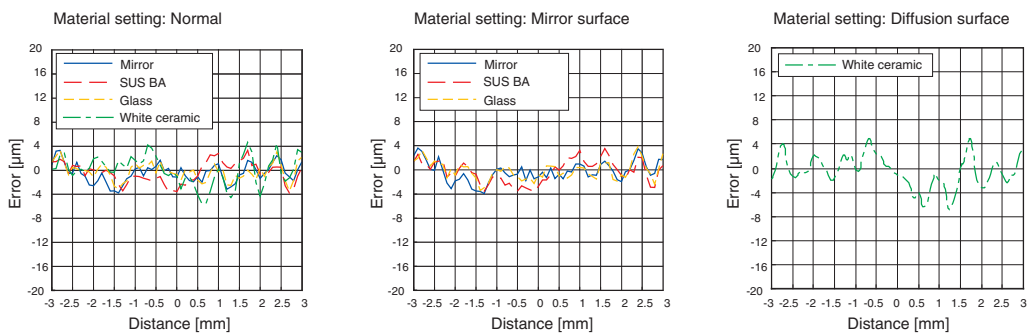

ZW-S40

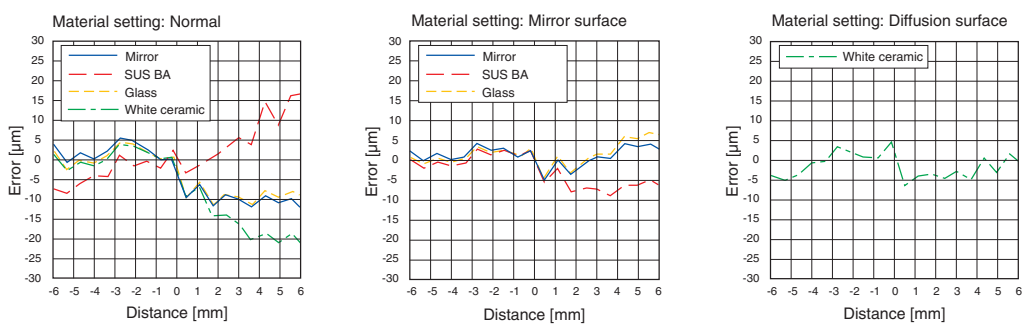

Right-angle type

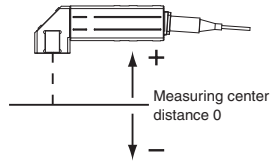

ZW-SR07

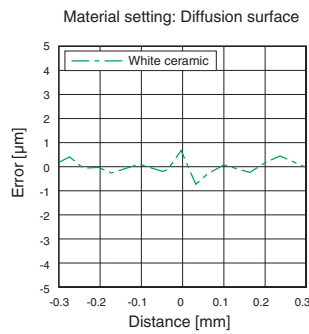
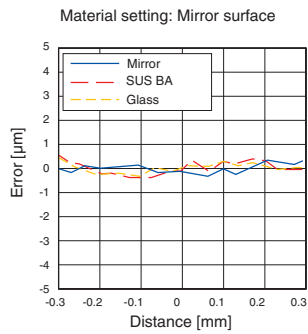
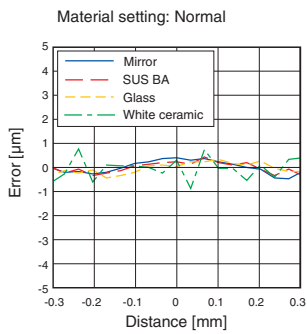

ZW-SR20

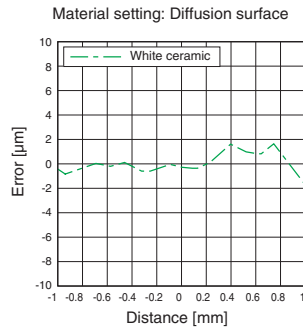
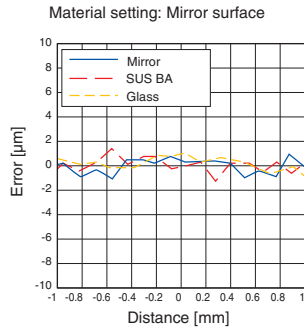
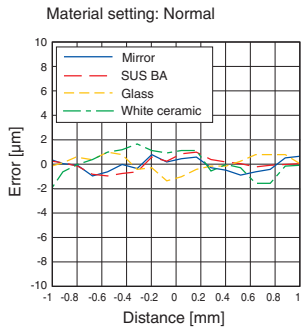

ZW-SR40

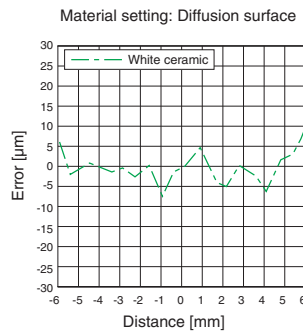
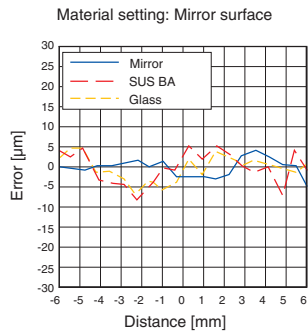
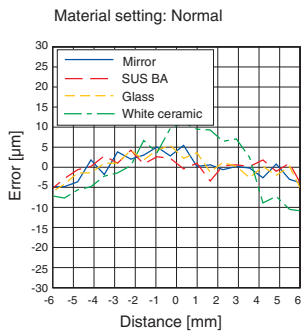

● Angle Characteristic *
Straight type

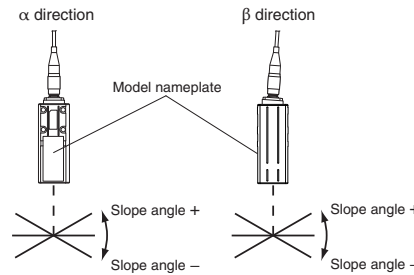

* The above show the results after executing scaling.

ZW-S07

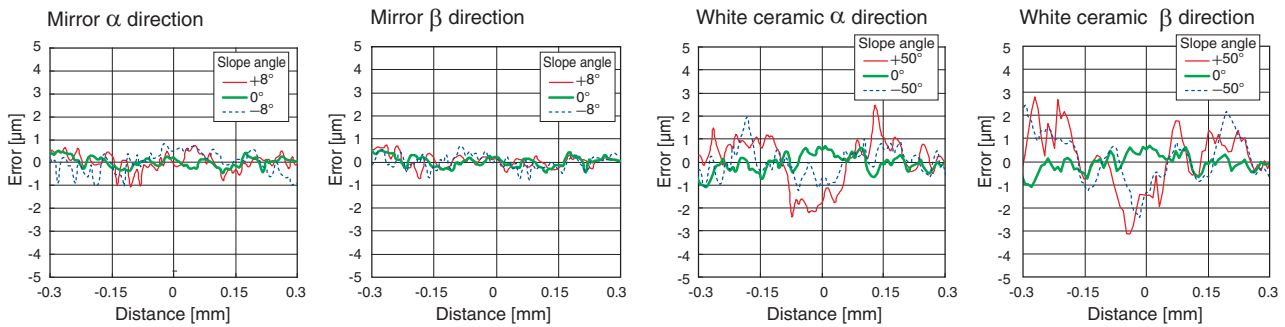

ZW-S20

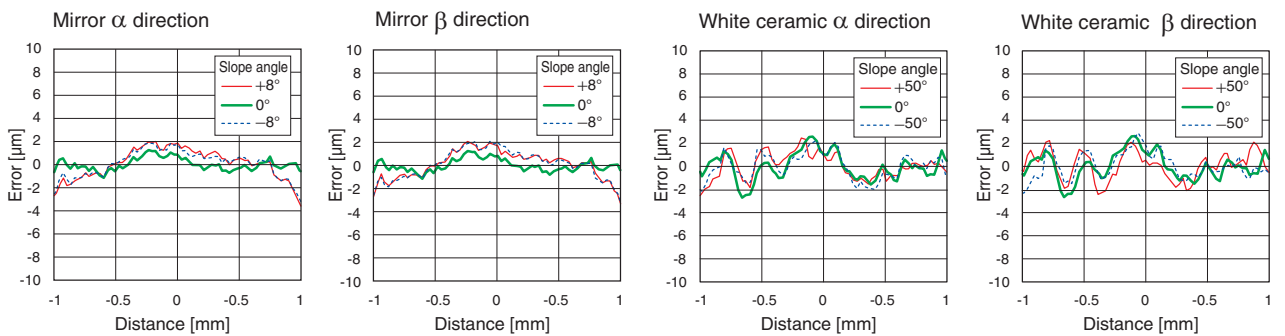

ZW-S30

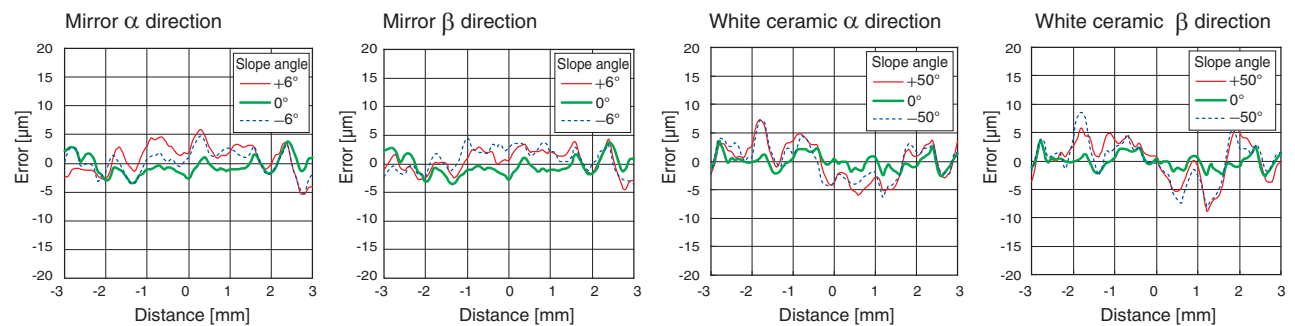

ZW-S40

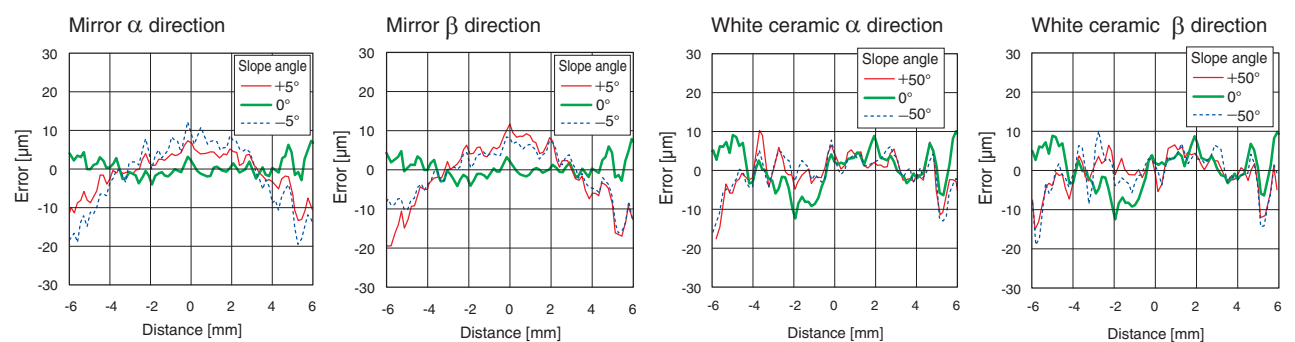

Right-angle type

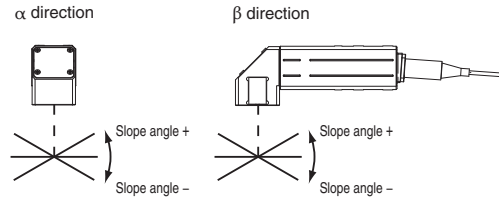

* The above show the results after executing scaling.

ZW-SR07

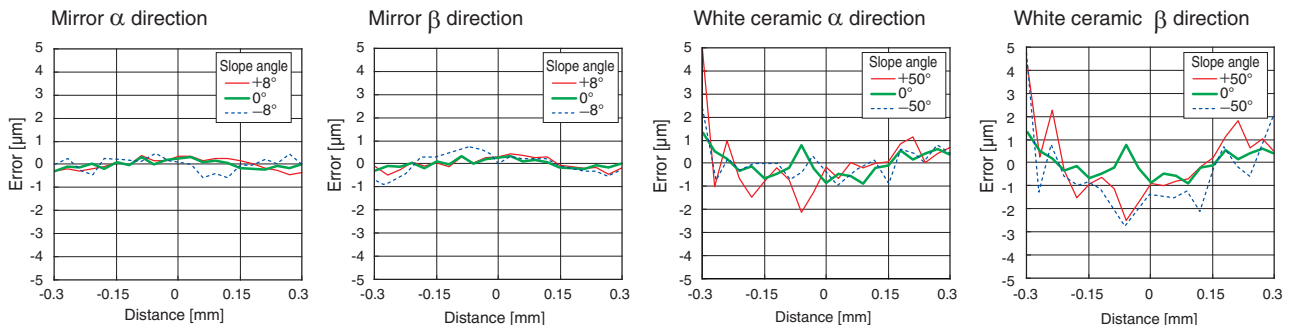

ZW-SR20

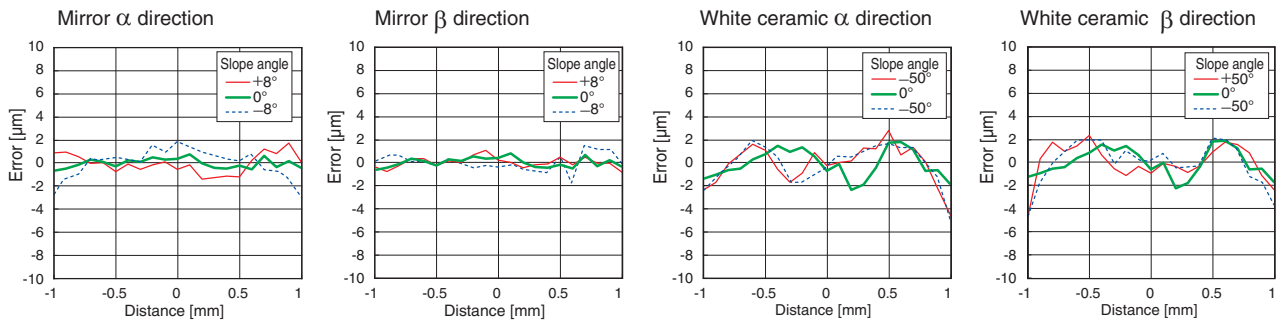

ZW-SR40

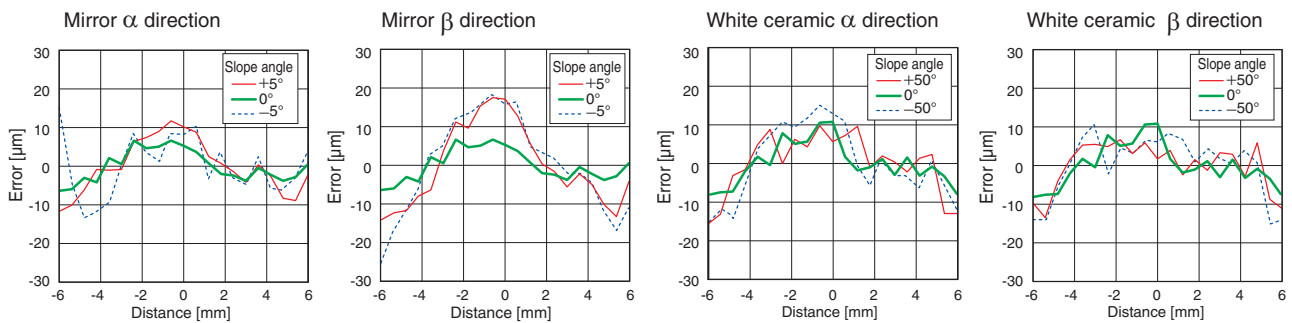

External Dimensions

(Unit: mm)

Sensor Head Straight type

ZW-S07/-S20/-S30/-S40

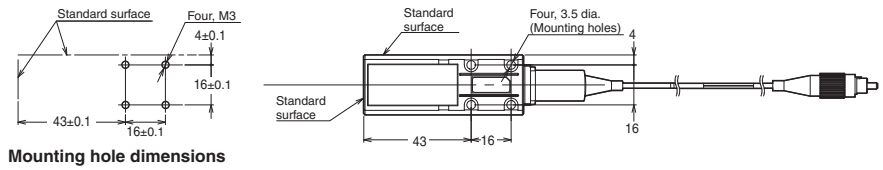

Note:

| Model | L | M | X |
|--------|----|-----|------|
| ZW-S07 | 7 | 0.3 | 12 |
| ZW-S20 | 20 | 1 | 11.8 |
| ZW-S30 | 30 | 3 | 11.7 |
| ZW-S40 | 40 | 6 | 11.7 |

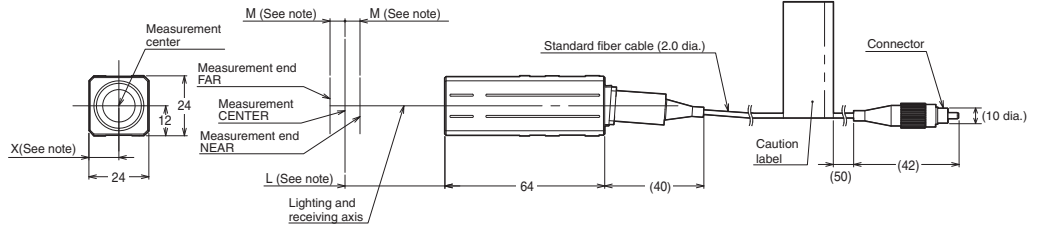

Right-angle type

ZW-SR07/-SR20/-SR40

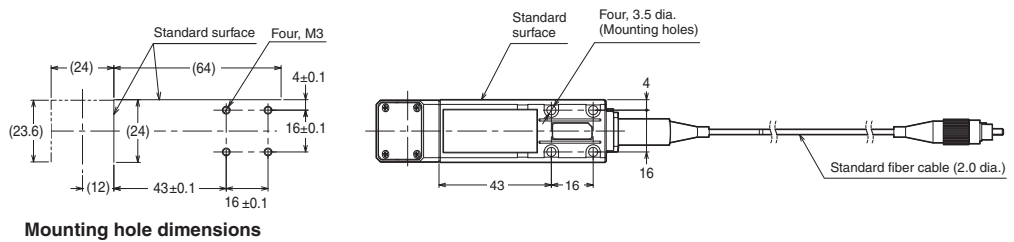

Note:

| Model | L | M |
|---------|----|-----|
| ZW-SR07 | 7 | 0.3 |
| ZW-SR20 | 20 | 1 |
| ZW-SR40 | 40 | 6 |

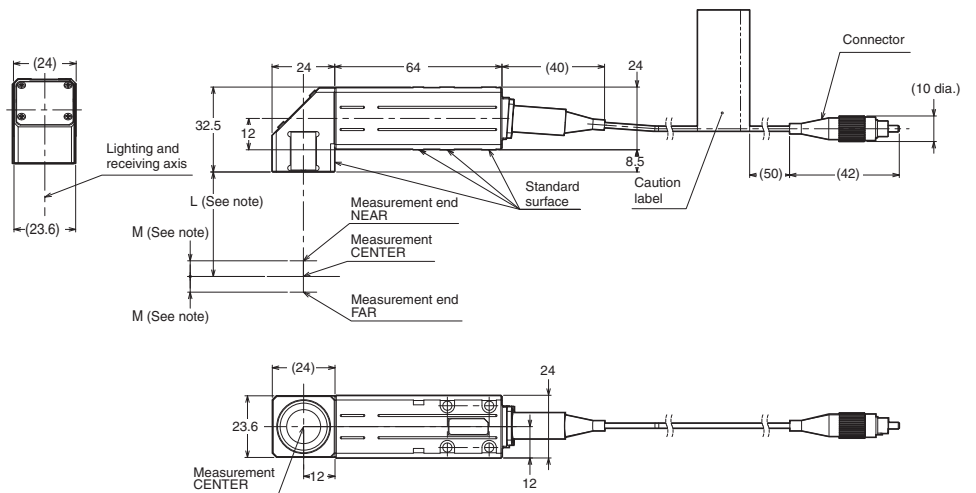

Controller

ZW-CE10T/-CE15T

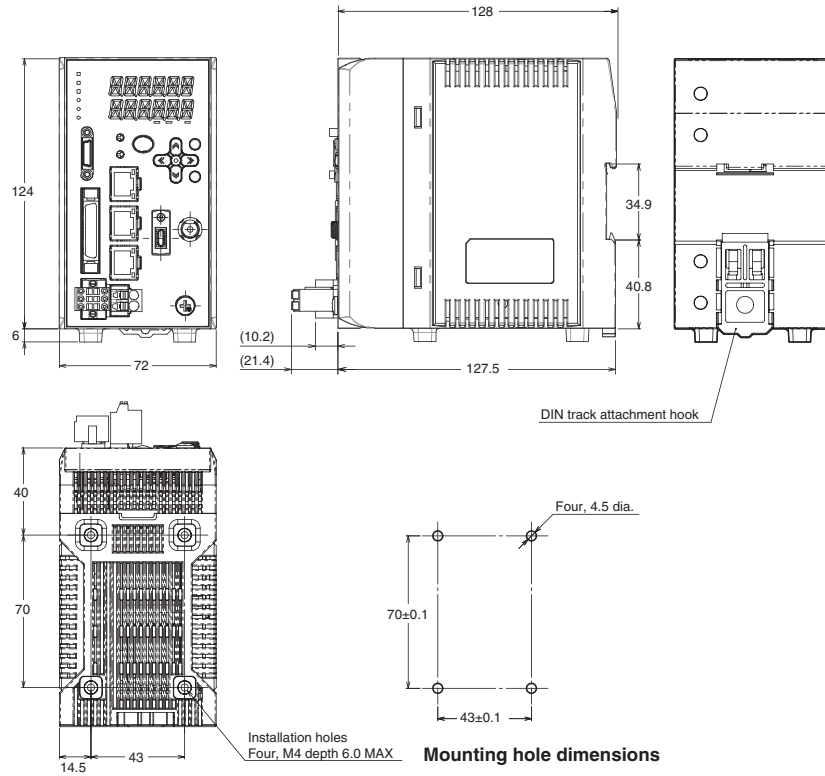

Extension Fiber Cable

ZW-XF02R/-XF05R/-XF10R/-XF20R/-XF30R

Note: The following table lists cable lengths per models.

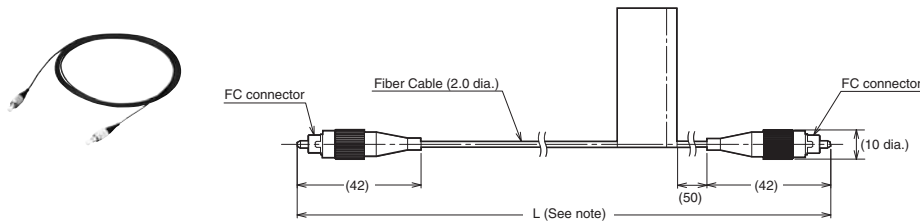

| Model | Cable length | L |
|----------|--------------|------------|
| ZW-XF02R | 2 m | 2,000±20 |
| ZW-XF05R | 5 m | 5,000±50 |
| ZW-XF10R | 10 m | 10,000±100 |
| ZW-XF20R | 20 m | 20,000±200 |
| ZW-XF30R | 30 m | 30,000±300 |

Related Manuals

| Man.No. | Model number | Manual |
|---------|--------------|---------------------------------------------------------------|
| Z332 | ZW-CE1□T | Displacement Measurement Sensor ZW-CE1□T Series User's Manual |

Terms and Conditions Agreement

Read and understand this catalog.

Please read and understand this catalog before purchasing the products. Please consult your OMRON representative if you have any questions or comments.

Warranties.

- (a) Exclusive Warranty. Omron's exclusive warranty is that the Products will be free from defects in materials and workmanship for a period of twelve months from the date of sale by Omron (or such other period expressed in writing by Omron). Omron disclaims all other warranties, express or implied.
- (b) Limitations. OMRON MAKES NO WARRANTY OR REPRESENTATION, EXPRESS OR IMPLIED, ABOUT NON-INFRINGEMENT, MERCHANTABILITY OR FITNESS FOR A PARTICULAR PURPOSE OF THE PRODUCTS. BUYER ACKNOWLEDGES THAT IT ALONE HAS DETERMINED THAT THE PRODUCTS WILL SUITABLY MEET THE REQUIREMENTS OF THEIR INTENDED USE.

Omron further disclaims all warranties and responsibility of any type for claims or expenses based on infringement by the Products or otherwise of any intellectual property right. (c) Buyer Remedy. Omron's sole obligation hereunder shall be, at Omron's election, to (i) replace (in the form originally shipped with Buyer responsible for labor charges for removal or replacement thereof) the non-complying Product, (ii) repair the non-complying Product, or (iii) repay or credit Buyer an amount equal to the purchase price of the non-complying Product; provided that in no event shall Omron be responsible for warranty, repair, indemnity or any other claims or expenses regarding the Products unless Omron's analysis confirms that the Products were properly handled, stored, installed and maintained and not subject to contamination, abuse, misuse or inappropriate modification. Return of any Products by Buyer must be approved in writing by Omron before shipment. Omron Companies shall not be liable for the suitability or unsuitability or the results from the use of Products in combination with any electrical or electronic components, circuits, system assemblies or any other materials or substances or environments. Any advice, recommendations or information given orally or in writing, are not to be construed as an amendment or addition to the above warranty.

See <http://www.omron.com/global/> or contact your Omron representative for published information.

Limitation on Liability; Etc.

OMRON COMPANIES SHALL NOT BE LIABLE FOR SPECIAL, INDIRECT, INCIDENTAL, OR CONSEQUENTIAL DAMAGES, LOSS OF PROFITS OR PRODUCTION OR COMMERCIAL LOSS IN ANY WAY CONNECTED WITH THE PRODUCTS, WHETHER SUCH CLAIM IS BASED IN CONTRACT, WARRANTY, NEGLIGENCE OR STRICT LIABILITY.

Further, in no event shall liability of Omron Companies exceed the individual price of the Product on which liability is asserted.

Suitability of Use.

Omron Companies shall not be responsible for conformity with any standards, codes or regulations which apply to the combination of the Product in the Buyer's application or use of the Product. At Buyer's request, Omron will provide applicable third party certification documents identifying ratings and limitations of use which apply to the Product. This information by itself is not sufficient for a complete determination of the suitability of the Product in combination with the end product, machine, system, or other application or use. Buyer shall be solely responsible for determining appropriateness of the particular Product with respect to Buyer's application, product or system. Buyer shall take application responsibility in all cases.

NEVER USE THE PRODUCT FOR AN APPLICATION INVOLVING SERIOUS RISK TO LIFE OR PROPERTY OR IN LARGE QUANTITIES WITHOUT ENSURING THAT THE SYSTEM AS A WHOLE HAS BEEN DESIGNED TO ADDRESS THE RISKS, AND THAT THE OMRON PRODUCT(S) IS PROPERLY RATED AND INSTALLED FOR THE INTENDED USE WITHIN THE OVERALL EQUIPMENT OR SYSTEM.

Programmable Products.

Omron Companies shall not be responsible for the user's programming of a programmable Product, or any consequence thereof.

Performance Data.

Data presented in Omron Company websites, catalogs and other materials is provided as a guide for the user in determining suitability and does not constitute a warranty. It may represent the result of Omron's test conditions, and the user must correlate it to actual application requirements. Actual performance is subject to the Omron's Warranty and Limitations of Liability.

Change in Specifications.

Product specifications and accessories may be changed at any time based on improvements and other reasons. It is our practice to change part numbers when published ratings or features are changed, or when significant construction changes are made. However, some specifications of the Product may be changed without any notice. When in doubt, special part numbers may be assigned to fix or establish key specifications for your application. Please consult with your Omron's representative at any time to confirm actual specifications of purchased Product.

Errors and Omissions.

Information presented by Omron Companies has been checked and is believed to be accurate; however, no responsibility is assumed for clerical, typographical or proofreading errors or omissions.

Would you like to know more?

Omron Europe B.V.

 +31 (0) 23 568 13 00

 industrial.omron.eu

Stay in touch

 twitter.com/omroneurope

 youtube.com/user/omroneurope

 linkedin.com/company/omron

Austria

Tel: +43 (0) 2236 377 800
industrial.omron.at

Belgium

Tel: +32 (0) 2 466 24 80
industrial.omron.be

Czech Republic

Tel: +420 234 602 602
industrial.omron.cz

Denmark

Tel: +45 43 44 00 11
industrial.omron.dk

Finland

Tel: +358 (0) 207 464 200
industrial.omron.fi

France

Tel: +33 (0) 1 56 63 70 00
industrial.omron.fr

Germany

Tel: +49 (0) 2173 680 00
industrial.omron.de

Hungary

Tel: +36 1 399 30 50
industrial.omron.hu

Italy

Tel: +39 02 326 81
industrial.omron.it

Netherlands

Tel: +31 (0) 23 568 11 00
industrial.omron.nl

Norway

Tel: +47 (0) 22 65 75 00
industrial.omron.no

Poland

Tel: +48 22 458 66 66
industrial.omron.pl

Portugal

Tel: +351 21 942 94 00
industrial.omron.pt

Russia

Tel: +7 495 648 94 50
industrial.omron.ru

South Africa

Tel: +27 (0)11 579 2600
industrial.omron.co.za

Spain

Tel: +34 902 100 221
industrial.omron.es

Sweden

Tel: +46 (0) 8 632 35 00
industrial.omron.se

Switzerland

Tel: +41 (0) 41 748 13 13
industrial.omron.ch

Turkey

Tel: +90 212 467 30 00
industrial.omron.com.tr

United Kingdom

Tel: +44 (0) 1908 258 258
industrial.omron.co.uk

More Omron representatives

industrial.omron.eu